

***Nikon***

DIGITAL CAMERA

# D300s

---

User's Manual

En

# Where to Find It

Find what you're looking for from:



## The Table of Contents



x–xvii

Find items by function or menu name.



## The Q&A Index



iv–ix

Know what you want to do but don't know the function name? Find it from the "question and answer" index.



## The Index



398–403

Search by key word.



## Error Messages



378–384

If a warning is displayed in the viewfinder or monitor, find the solution here.



## Troubleshooting



373–377

Camera behaving unexpectedly? Find the solution here.



## For Your Safety

Before using the camera for the first time, read the safety instructions in "For Your Safety" ( xviii–xx).

## Help

Use the camera's on-board help feature for help on menu items and other topics. See page 21 for details.

## Digitutor

Digitutor, a series of "watch and learn" manuals in movie form, is available from the following website:

**[http://www.nikondigitutor.com/index\\_eng.html](http://www.nikondigitutor.com/index_eng.html)**

# Package Contents

Be sure all items listed here were included with your camera.

*Memory cards are sold separately.*

- D300S digital camera (□ 3)
- BF-1A body cap (□ 26, 355)
- BM-8 monitor cover (□ 16)
- BS-1 accessory shoe cover (□ 347)

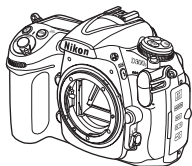

- EN-EL3e rechargeable Li-ion battery with terminal cover (□ 22, 24)
- MH-18a quick charger with power cable (□ 22)
- DK-5 eyepiece cap (□ 91, 191)

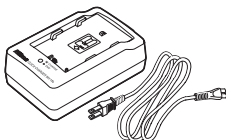
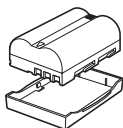

- DK-23 rubber eyecup (□ 91, 191)



- EG-D2 audio/video cable (□ 239)
- UC-E4 USB cable (□ 224, 229)
- AN-DC4 strap

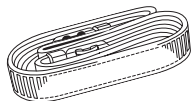
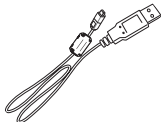
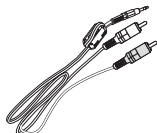

- 
- Warranty
  - *User's Manual* (this guide)
  - *Quick Guide*
  - *Software Installation Guide*
  - Software Suite CD-ROM
  - Registration card (U. S. A. only)

# Symbols and Conventions

To make it easier to find the information you need, the following symbols and conventions are used:



This icon marks cautions; information that should be read before use to prevent damage to the camera.



This icon marks notes; information that should be read before using the camera.



This icon marks references to other pages in this manual.

Menu items, options, and messages displayed in the camera monitor are shown in **bold**.













## **Trademark Information**

Macintosh, Mac OS, and QuickTime are registered trademarks of Apple Inc. Microsoft, Windows and Windows Vista are either registered trademarks, or trademarks of Microsoft Corporation in the United States and/or other countries. CompactFlash is a trademark of SanDisk Corporation. The SD logo is a trademark of the SD Card Association. PictBridge and the SDHC logo are trademarks. HDMI, the HDMI logo and High-Definition Multimedia Interface are trademarks or registered trademarks of HDMI Licensing LLC. All other trade names mentioned in this manual or the other documentation provided with your Nikon product are trademarks or registered trademarks of their respective holders.



# D300s

<b>Q&amp;A Index</b>	 <b>iv</b>
<b>Table of Contents</b>	 <b>x</b>
 <b>Introduction</b>	 <b>1</b>
 <b>Tutorial</b>	 <b>17</b>
 <b>Framing Pictures in the Monitor (Live View)</b>	 <b>47</b>
 <b>Recording and Viewing Movies</b>	 <b>57</b>
 <b>Image Recording Options</b>	 <b>67</b>
 <b>Focus</b>	 <b>73</b>
 <b>Release Mode</b>	 <b>85</b>
 <b>ISO Sensitivity</b>	 <b>95</b>
 <b>Exposure</b>	 <b>101</b>
 <b>White Balance</b>	 <b>133</b>
 <b>Image Enhancement</b>	 <b>153</b>
 <b>Flash Photography</b>	 <b>169</b>
 <b>Other Shooting Options</b>	 <b>181</b>
 <b>More About Playback</b>	 <b>203</b>
 <b>Connections</b>	 <b>223</b>
 <b>Menu Guide</b>	 <b>243</b>
 <b>Technical Notes</b>	 <b>339</b>

## Q&A Index

Find what you're looking for using this "question and answer" index.

### ■ ■ New Features

Question	Key phrase	📖
<i>How do I take high-quality NEF (RAW) photos?</i>	> 14-bit NEF (RAW)	70
<i>Can I use the monitor as a viewfinder?</i>	> Live view	47
<i>How do I shoot movies?</i>	> Movies	57
<i>How do I record photographs using two memory cards?</i>	> Primary slot, secondary slot	72
<i>Can I control how photos are processed?</i>	> Picture Controls	154
<i>How do I preserve details in shadows and highlights?</i>	> Active D-Lighting	164
<i>How do I focus on erratically moving subjects?</i>	> 3D-tracking	265
<i>How do I tell if the camera is level?</i>	> Virtual horizon	311
<i>Can I adjust focus separately for different lenses?</i>	> AF fine tune	312
<i>How do I remove dust from the low-pass filter protecting the image sensor?</i>	> Cleaning the low-pass filter	358

### ■ ■ Camera Setup

Question	Key phrase	📖
<i>How do I focus the viewfinder?</i>	> Viewfinder focus	36
<i>How do I keep the monitor from turning off?</i>	> Monitor off delay	274
<i>How do I keep the shutter speed and aperture displays from turning off?</i>	> Auto meter off	39, 273
<i>Can I display a framing grid in the viewfinder?</i>	> Viewfinder grid display	275

Question	Key phrase	
<b>How do I set the clock?</b>		
<b>How do I set the clock for daylight savings time?</b>	> Time zone and date	29, 302
<b>How do I change time zones when I travel?</b>		
<b>How do I adjust monitor brightness for menus or playback?</b>	> LCD brightness	301
<b>How do I change the self-timer delay?</b>	> Self-timer	273
<b>How do I turn the speaker off?</b>	> Beep	275
<b>Can I reverse the exposure indicator?</b>	> Reverse indicators	299
<b>Can I display the menus in a different language?</b>	> Language	28, 303
<b>Can I save menu settings for use on a different D300S camera?</b>	> Save/load settings	310
<b>How do I restore default settings?</b>	> Two-button reset	182
<b>How do I restore shooting menu defaults?</b>	> Reset shooting menu	256
<b>How do I restore Custom Setting defaults?</b>	> Reset custom settings	262

## ■ ■ Menus and Displays

Question	Key phrase	
<b>How do I get more information on a menu?</b>	> Help	21
<b>How do I use the menus?</b>	> Using the menus	18
<b>Can I get quick access to frequently-used settings?</b>	> My Menu	333
<b>Can I get quick access to recently-used settings?</b>	> Recent settings	337
<b>What do these indicators mean?</b>	Viewfinder, control panel, information display	8, 10, 12
<b>What information is in the information display?</b>		
<b>What does this warning mean?</b>	> Error messages and displays	378
<b>How much charge does the battery have left?</b>	> Battery level	37

Question	Key phrase	📖
<i>How do I get more information about the battery?</i>	> Battery info	307
<i>How do I keep the file number from being reset when I insert a new memory card?</i>	> File number sequence	277
<i>How do I reset file numbering to 1?</i>		
<i>How do I clean the camera or lens?</i>	> Cleaning the camera	357

## ■ ■ Taking Photographs

Question	Key phrase	📖
<i>How many more shots can I take with this card?</i>	> Number of exposures remaining	38
<i>How do I take bigger photographs?</i>		
<i>How can I get more photos on the memory card?</i>	> Image quality and size	68, 71
<i>How do I make an NEF (RAW) copy of the next photo?</i>	> +NEF (RAW)	294
<i>Can I control how the camera focuses?</i>	> Autofocus	74
<i>Can I choose the focus point?</i>	> Focus point	78
<i>How do I take a lot of photographs quickly?</i>	> Release mode	86
<i>Can I change the frame advance rate?</i>	> Shooting speed	89, 276
<i>How do I take pictures with the self-timer?</i>	> Self-timer mode	91
<i>Can I take pictures under low light without the flash?</i>	> ISO sensitivity	96
<i>Can the ISO sensitivity I choose be adjusted to ensure optimal exposure?</i>	> ISO sensitivity auto control	98
<i>How do I freeze or blur moving objects?</i>	> Exposure mode <b>S</b> (shutter-priority auto)	108
<i>How do I blur background details or keep both foreground and background in focus?</i>	> Exposure mode <b>A</b> (aperture-priority auto)	109

Question	Key phrase	
<b>Can I set both shutter speed and aperture manually?</b>	> Exposure mode M (manual)	111
<b>Can I make photos brighter or darker?</b>	> Exposure compensation	118
<b>How do I make a time exposure?</b>	> Long time-exposures	114
<b>Can I vary exposure or flash level automatically over a series of photos?</b>	> Exposure and flash bracketing	120, 289
<b>Can I create multiple copies of a photo using different white balance settings?</b>	> White balance bracketing	125, 289
<b>Can I vary Active D-Lighting automatically over a series of photos?</b>	> ADL bracketing	129, 289
<b>How do I adjust white balance?</b>	> White balance	133
<b>Can I take pictures with a flash?</b>	> Flash photography, flash mode, red-eye reduction	171
<b>How can I reduce "red-eye"?</b>	> Flash photography, flash mode, red-eye reduction	175
<b>How can I record multiple shots as a single photograph?</b>	> Multiple exposure	184
<b>Can I pick the standard exposure level?</b>	> Fine tune optimal exposure	272
<b>How can I reduce blur?</b>	> Exposure delay mode	278
<b>Can the flash be used at shutter speeds faster than <math>1/250</math> s?</b>	> Flash sync speed	281

## ■ Viewing Photographs

Question	Key phrase	
<b>Can I view my photographs on the camera?</b>	> Camera playback	204
<b>Can I view more information about photos?</b>	> Photo info	207
<b>Why do parts of my photos blink?</b>	> Photo info, highlights	209, 247

Question	Key phrase	Page
<i>How do I get rid of an unwanted photo?</i>	Deleting individual photos	220
<i>Can I delete several photos at once?</i>	Delete	221
<i>Can I zoom in on pictures?</i>	Playback zoom	218
<i>Can I protect photos from accidental deletion?</i>	Protect	219
<i>Can I hide selected photos?</i>	Hide image	245
<i>How do I tell if parts of my photos may be overexposed?</i>	Display mode: highlights	209, 247
<i>How do I tell where the camera focused?</i>	Display mode: focus point	208, 247
<i>Can I view photos as they are taken?</i>	Image review	251
<i>Is there an automatic playback (“slide show”) option?</i>	Slide show	252

## ■ ■ Retouching Photographs

Question	Key phrase	Page
<i>How do I bring out details in shadows?</i>	D-Lighting	319
<i>Can I get rid of red eye?</i>	Red-eye correction	320
<i>Can I crop photographs on the camera?</i>	Trim	321
<i>Can I create a monochrome copy of a photograph?</i>	Monochrome	322
<i>Can I create a copy with different colors?</i>	Filter effects, Color balance	322, 323
<i>Can I use the camera to create JPEG copies of NEF (RAW) photographs?</i>	NEF (RAW) Processing	327
<i>Can I overlay two NEF (RAW) photos to make a single image?</i>	Image overlay	324

## ■■ Viewing or Printing Photographs on Other Devices

Question	Key phrase	📖
<i>Can I view my photos on TV?</i>	> Television playback	239
<i>Can I view my photos in High Definition?</i>	> HDMI	241
<i>How do I copy photos to my computer?</i>	> Connecting to a computer	224
<i>How do I print photographs?</i>	> Printing photographs	228
<i>Can I print photos without a computer?</i>	> Printing via USB	229
<i>Can I print the date on my photographs?</i>	> Time stamp	231
<i>How do I order professional prints?</i>	> Print set (DPOF)	237

## ■■ Optional Accessories

Question	Key phrase	📖
<i>What memory cards can I use?</i>	> Approved memory cards	393
<i>What lenses can I use?</i>	> Compatible lenses	340
<i>What optional flash units (Speedlights) can I use?</i>	> Optional flash units	347
<i>What software is available for my camera?</i>	> Other accessories	355
<i>What AC adapters, battery packs, remote cords, and viewfinder accessories are available for my camera?</i>	> Other accessories	352

# Table of Contents

Q&A Index .....	iv
For Your Safety .....	xviii
Notices.....	xxi

## **Introduction** **1**

---

Overview.....	2
Getting to Know the Camera.....	3
Camera Body .....	3
The Control Panel.....	8
The Viewfinder Display.....	10
The Information Display.....	12
The BM-8 Monitor Cover .....	16

## **Tutorial** **17**

---

Camera Menus.....	18
Using Camera Menus .....	19
Help .....	21
First Steps .....	22
Charge the Battery .....	22
Insert the Battery .....	24
Attach a Lens.....	26
Basic Setup.....	28
Insert a Memory Card.....	31
Format the Memory Card .....	34
Adjust Viewfinder Focus .....	36
Basic Photography and Playback.....	37
Turn the Camera On .....	37
Adjust Camera Settings.....	40
Ready the Camera .....	42
Focus and Shoot .....	43
Viewing Photographs .....	45



Deleting Unwanted Photographs.....	46
<b>Framing Pictures in the Monitor (Live View)</b>	<b>47</b>
<hr/>	
Framing Photographs in the Monitor .....	48
<b>Recording and Viewing Movies</b>	<b>57</b>
<hr/>	
Recording Movies.....	58
Viewing Movies .....	63
Editing Movies .....	64
<b>Image Recording Options</b>	<b>67</b>
<hr/>	
Image Quality.....	68
Image Size .....	71
Using Two Memory Cards .....	72
<b>Focus</b>	<b>73</b>
<hr/>	
Focus Mode .....	74
AF-Area Mode .....	76
Focus Point Selection.....	78
Focus Lock.....	80
Manual Focus .....	83
<b>Release Mode</b>	<b>85</b>
<hr/>	
Choosing a Release Mode .....	86
Continuous Mode.....	88
Self-Timer Mode.....	91
Mirror up Mode .....	93

## **ISO Sensitivity** **95**

---

Choosing ISO Sensitivity Manually.....	96
Auto ISO Sensitivity Control .....	98

## **Exposure** **101**

---

Metering .....	102
Exposure Mode.....	104
<i>P</i> : Programmed Auto .....	106
<i>S</i> : Shutter-Priority Auto .....	108
<i>A</i> : Aperture-Priority Auto .....	109
<i>M</i> : Manual .....	111
Long Time-Exposures.....	114
Autoexposure (AE) Lock.....	116
Exposure Compensation.....	118
Bracketing .....	120

## **White Balance** **133**

---

White Balance Options .....	134
Fine-Tuning White Balance.....	137
Choosing a Color Temperature .....	141
Preset Manual .....	142

## **Image Enhancement** **153**

---

Picture Controls.....	154
Selecting a Picture Control.....	154
Creating Custom Picture Controls.....	160
Active D-Lighting.....	164
Color Space .....	166

## **Flash Photography** **169**

---

The Built-in Flash .....	170
Using the Built-in Flash.....	171
Flash Modes.....	175
Flash Compensation.....	177
FV Lock .....	178

## **Other Shooting Options** **181**

---

Two-Button Reset: Restoring Default Settings .....	182
Multiple Exposure .....	184
Interval Timer Photography .....	189
Non-CPU Lenses.....	195
Using a GPS Unit .....	198

## **More About Playback** **203**

---

Full-Frame Playback .....	204
Photo Information.....	207
Viewing Multiple Images: Thumbnail Playback .....	216
Taking a Closer Look: Playback Zoom.....	218
Protecting Photographs from Deletion.....	219
Deleting Photographs .....	220
Full-Frame and Thumbnail Playback .....	220
The Playback Menu .....	221

## **Connections** **223**

---

Connecting to a Computer .....	224
Direct USB Connection .....	225
Wireless and Ethernet Networks .....	227
Printing Photographs.....	228
Connecting the Printer .....	229
Printing Pictures One at a Time .....	230

Printing Multiple Pictures .....	233
Creating a DPOF Print Order: Print Set .....	237
Viewing Photographs on TV .....	239
Standard Definition Devices .....	239
High-Definition Devices .....	241

## Menu Guide

**243**

▶ The Playback Menu: Managing Images .....	244
Playback Folder .....	245
Hide Image .....	245
Display Mode .....	247
Copy Image(s) .....	248
Image Review .....	251
After Delete .....	251
Rotate Tall .....	251
Slide Show .....	252
📷 The Shooting Menu: Shooting Options .....	253
Shooting Menu Bank .....	254
Reset Shooting Menu .....	256
Active Folder .....	256
File Naming .....	258
Long Exp. NR (Long Exposure Noise Reduction) .....	258
High ISO NR .....	259
🔧 Custom Settings: Fine-Tuning Camera Settings .....	260
Ⓜ: Custom Setting Bank .....	262
Ⓜ: Reset Custom Settings .....	262
a: Autofocus .....	263
a1: AF-C Priority Selection .....	263
a2: AF-S Priority Selection .....	264
a3: Dynamic AF Area .....	264
a4: Focus Tracking with Lock-On .....	266
a5: AF Activation .....	266
a6: AF Point Illumination .....	266
a7: Focus Point Wrap-Around .....	267
a8: AF Point Selection .....	267
a9: Built-in AF-assist Illuminator .....	268
a10: AF-On for MB-D10 .....	269

b: Metering/Exposure.....	270
b1: ISO Sensitivity Step Value .....	270
b2: EV Steps for Exposure Cntrl. ....	270
b3: Exp Comp/Fine Tune .....	270
b4: Easy Exposure Compensation .....	271
b5: Center-Weighted Area .....	272
b6: Fine Tune Optimal Exposure.....	272
c: Timers/AE Lock .....	273
c1: Shutter-Release Button AE-L .....	273
c2: Auto Meter-off Delay .....	273
c3: Self-Timer.....	273
c4: Monitor off Delay.....	274
d: Shooting/Display.....	275
d1: Beep .....	275
d2: Viewfinder Grid Display .....	275
d3: Viewfinder Warning Display.....	275
d4: Screen Tips.....	276
d5: CL Mode Shooting Speed .....	276
d6: Max. Continuous Release .....	276
d7: File Number Sequence.....	277
d8: Information Display.....	278
d9: LCD Illumination.....	278
d10: Exposure Delay Mode .....	278
d11: MB-D10 Battery Type .....	279
d12: Battery Order .....	280
e: Bracketing/Flash .....	281
e1: Flash Sync Speed .....	281
e2: Flash Shutter Speed.....	282
e3: Flash Cntrl for Built-in Flash.....	283
e4: Modeling Flash .....	289
e5: Auto Bracketing Set.....	289
e6: Auto Bracketing (Mode M) .....	290
e7: Bracketing Order.....	290
f: Controls.....	291
f1:  Switch .....	291
f2: Multi Selector Center Button.....	291
f3: Multi Selector .....	292
f4: Photo Info/Playback.....	292
f5: Assign Fn Button.....	292

f6: Assign Preview Button .....	296
f7: Assign AE-L/AF-L Button .....	296
f8: Customize Command Dials .....	297
f9: Release Button to Use Dial.....	298
f10: No Memory Card?.....	299
f11: Reverse Indicators .....	299
<b>Y</b> The Setup Menu: Camera Setup.....	<b>300</b>
Format Memory Card .....	301
LCD Brightness.....	301
Video Mode .....	301
HDMI.....	302
Time Zone and Date .....	302
Language .....	303
Image Comment .....	303
Auto Image Rotation .....	304
Image Dust Off Ref Photo .....	305
Battery Info.....	307
Wireless Transmitter .....	308
Image Authentication .....	308
Copyright Information .....	309
Save/Load Settings.....	310
Virtual Horizon .....	311
AF Fine Tune .....	312
Eye-Fi Upload .....	313
Firmware Version .....	314
<b>☑</b> The Retouch Menu: Creating Retouched Copies .....	<b>315</b>
D-Lighting.....	319
Red-Eye Correction.....	320
Trim .....	321
Monochrome .....	322
Filter Effects.....	322
Color Balance.....	323
Image Overlay .....	324
NEF (RAW) Processing .....	327
Resize.....	329
Side-by-Side Comparison .....	331
<b>☑</b> My Menu: Creating a Custom Menu .....	<b>333</b>

Compatible Lenses .....	340
Optional Flash Units (Speedlights).....	347
The Nikon Creative Lighting System (CLS) .....	348
Other Accessories .....	352
Caring for the Camera.....	357
Storage.....	357
Cleaning .....	357
The Low-Pass Filter.....	358
“Clean Now” .....	358
“Clean at Startup/Shutdown” .....	359
Manual Cleaning.....	361
Caring for the Camera and Battery: Cautions.....	364
Defaults .....	368
Exposure Program.....	372
Troubleshooting .....	373
Error Messages .....	378
Specifications .....	385
Approved Memory Cards .....	393
Memory Card Capacity .....	394
Battery Life .....	396
Index.....	398

# For Your Safety

To prevent damage to your Nikon product or injury to yourself or to others, read the following safety precautions in their entirety before using this equipment. Keep these safety instructions where all those who use the product will read them.

The consequences that could result from failure to observe the precautions listed in this section are indicated by the following symbol:



This icon marks warnings. To prevent possible injury, read all warnings before using this Nikon product.

## ■ ■ WARNINGS

- ⚠ Keep the sun out of the frame**  
Keep the sun well out of the frame when shooting backlit subjects. Sunlight focused into the camera when the sun is in or close to the frame could cause a fire.
- ⚠ Do not look at the sun through the viewfinder**  
Viewing the sun or other strong light source through the viewfinder could cause permanent visual impairment.
- ⚠ Using the viewfinder diopter control**  
When operating the viewfinder diopter control with your eye to the viewfinder, care should be taken not to put your finger in your eye accidentally.
- ⚠ Turn off immediately in the event of malfunction**  
Should you notice smoke or an unusual smell coming from the equipment or AC adapter (available separately), unplug the AC adapter and remove the battery immediately, taking care to avoid burns. Continued operation could result in injury. After removing the battery, take the equipment to a Nikon-authorized service center for inspection.
- ⚠ Do not disassemble**  
Touching the product's internal parts could result in injury. In the event of malfunction, the product should be repaired only by a qualified technician. Should the product break open as the result of a fall or other accident, remove the battery and/or AC adapter and then take the product to a Nikon-authorized service center for inspection.



- ⚠ **Do not use in the presence of flammable gas**  
Do not use electronic equipment in the presence of flammable gas, as this could result in explosion or fire.
- ⚠ **Keep out of reach of children**  
Failure to observe this precaution could result in injury.
- ⚠ **Do not place the strap around the neck of an infant or child**  
Placing the camera strap around the neck of an infant or child could result in strangulation.
- ⚠ **Observe proper precautions when handling batteries**  
Batteries may leak or explode if improperly handled. Observe the following precautions when handling batteries for use in this product:
  - Use only batteries approved for use in this equipment.
  - Do not short or disassemble the battery.
  - Be sure the product is off before replacing the battery. If you are using an AC adapter, be sure it is unplugged.
  - Do not attempt to insert the battery upside down or backwards.
  - Do not expose the battery to flame or to excessive heat.
  - Do not immerse in or expose to water.
- Replace the terminal cover when transporting the battery. Do not transport or store the battery with metal objects such as necklaces or hairpins.
- Batteries are prone to leakage when fully discharged. To avoid damage to the product, be sure to remove the battery when no charge remains.
- When the battery is not in use, attach the terminal cover and store in a cool, dry place.
- The battery may be hot immediately after use or when the product has been used on battery power for an extended period. Before removing the battery turn the camera off and allow the battery to cool.
- Discontinue use immediately should you notice any changes in the battery, such as discoloration or deformation.

**⚠ Observe proper precautions when handling the quick charger**

- Keep dry. Failure to observe this precaution could result in fire or electric shock.
- Dust on or near the metal parts of the plug should be removed with a dry cloth. Continued use could result in fire.
- Do not handle the power cable or go near the charger during thunderstorms. Failure to observe this precaution could result in electric shock.
- Do not damage, modify, or forcibly tug or bend the power cable. Do not place it under heavy objects or expose it to heat or flame. Should the insulation be damaged and the wires become exposed, take the power cable to a Nikon-authorized service representative for inspection. Failure to observe this precaution could result in fire or electric shock.
- Do not handle the plug or charger with wet hands. Failure to observe this precaution could result in electric shock.
- Do not use with travel converters or adapters designed to convert from one voltage to another or with DC-to-AC inverters. Failure to observe this precaution could damage the product or cause overheating or fire.

**⚠ Use appropriate cables**

When connecting cables to the input and output jacks, use only the cables provided or sold by Nikon for the purpose to maintain compliance with product regulations.

**⚠ CD-ROMs**

CD-ROMs containing software or manuals should not be played back on audio CD equipment. Playing CD-ROMs on an audio CD player could cause hearing loss or damage the equipment.

**⚠ Observe caution when using the flash**

- Using the camera with the flash in close contact with the skin or other objects could cause burns.
- Using the flash close to the subject's eyes could cause temporary visual impairment. Particular care should be observed when photographing infants, when the flash should be no less than one meter (39 in.) from the subject.

**⚠ Avoid contact with liquid crystal**

Should the monitor break, care should be taken to avoid injury due to broken glass and to prevent the liquid crystal from the monitor touching the skin or entering the eyes or mouth.

# Notices

- No part of the manuals included with this product may be reproduced, transmitted, transcribed, stored in a retrieval system, or translated into any language in any form, by any means, without Nikon's prior written permission.
- Nikon reserves the right to change the specifications of the hardware and software described in these manuals at any time and without prior notice.
- Nikon will not be held liable for any damages resulting from the use of this product.
- While every effort has been made to ensure that the information in these manuals is accurate and complete, we would appreciate it were you to bring any errors or omissions to the attention of the Nikon representative in your area (address provided separately).

## Notices for Customers in the U.S.A.

### Federal Communications Commission (FCC) Radio Frequency Interference Statement

This equipment has been tested and found to comply with the limits for a Class B digital device, pursuant to Part 15 of the FCC rules. These limits are designed to provide reasonable protection against harmful interference in a residential installation. This equipment generates, uses, and can radiate radio frequency energy and, if not installed and used in accordance with the instructions, may cause harmful interference to radio communications. However, there is no guarantee that interference will not occur in a particular installation. If this equipment does cause harmful interference to radio or television reception, which can be determined by turning the equipment off and on, the user is encouraged to try to correct the interference by one or more of the following measures:

- Reorient or relocate the receiving antenna.
- Increase the separation between the equipment and receiver.
- Connect the equipment into an outlet on a circuit different from that to which the receiver is connected.
- Consult the dealer or an experienced radio/television technician for help.



### CAUTIONS

#### *Modifications*

The FCC requires the user be notified that any changes or modifications made to this device that are not expressly approved by Nikon Corporation may void the user's authority to operate the equipment.

#### *Interface Cables*

Use the interface cables sold or provided by Nikon for your equipment. Using other interface cables may exceed the limits of Class B Part 15 of the FCC rules.

#### **Notice for Customers in the State of California**

**WARNING:** Handling the cord on this product may expose you to lead, a chemical known to the State of California to cause birth defects or other reproductive harm. *Wash hands after handling.*

Nikon Inc., 1300 Walt Whitman Road,  
Melville, New York 11747-3064, U.S.A.  
Tel.: 631-547-4200

## Notices for Customers in Canada

### CAUTION

This Class B digital apparatus complies with Canadian ICES-003.

### ATTENTION

Cet appareil numérique de la classe B est conforme à la norme NMB-003 du Canada.

## Notices for Customers in Europe

This symbol indicates that this product is to be collected separately.

The following apply only to users in European countries:

- This product is designated for separate collection at an appropriate collection point. Do not dispose of as household waste.
- For more information, contact the retailer or the local authorities in charge of waste management.



This symbol on the battery indicates that the battery is to be collected separately.



The following apply only to users in European countries:

- All batteries, whether marked with this symbol or not, are designated for separate collection at an appropriate collection point. Do not dispose of as household waste.
- For more information, contact the retailer or the local authorities in charge of waste management.

## Disposing of Data Storage Devices

Please note that deleting images or formatting memory cards or other data storage devices does not completely erase the original image data. Deleted files can sometimes be recovered from discarded storage devices using commercially available software, potentially resulting in the malicious use of personal image data. Ensuring the privacy of such data is the user's responsibility.

Before discarding a data storage device or transferring ownership to another person, erase all data using commercial deletion software, or format the device and then completely refill it with images containing no private information (for example, pictures of empty sky). Be sure to also replace any pictures selected for preset manual. Care should be taken to avoid injury when physically destroying data storage devices.

## Notice Concerning Prohibition of Copying or Reproduction

Note that simply being in possession of material that has been digitally copied or reproduced by means of a scanner, digital camera, or other device may be punishable by law.

### • Items prohibited by law from being copied or reproduced

Do not copy or reproduce paper money, coins, securities, government bonds, or local government bonds, even if such copies or reproductions are stamped "Sample."

The copying or reproduction of paper money, coins, or securities which are circulated in a foreign country is prohibited.

Unless the prior permission of the government has been obtained, the copying or reproduction of unused postage stamps or post cards issued by the government is prohibited.

The copying or reproduction of stamps issued by the government and of certified documents stipulated by law is prohibited.

### • Cautions on certain copies and reproductions

The government has issued cautions on copies or reproductions of securities issued by private companies (shares, bills, checks, gift certificates, etc.), commuter passes, or coupon tickets, except when a minimum of necessary copies are to be provided for business use by a company. Also, do not copy or reproduce passports issued by the government, licenses issued by public agencies and private groups, ID cards, and tickets, such as passes and meal coupons.

### • Comply with copyright notices

The copying or reproduction of copyrighted creative works such as books, music, paintings, woodcuts, prints, maps, drawings, movies, and photographs is governed by national and international copyright laws. Do not use this product for the purpose of making illegal copies or to infringe copyright laws.

## Use Only Nikon Brand Electronic Accessories

Nikon cameras are designed to the highest standards and include complex electronic circuitry. Only Nikon brand electronic accessories (including battery chargers, batteries, AC adapters, and flash accessories) certified by Nikon specifically for use with this Nikon digital camera are engineered and proven to operate within the operational and safety requirements of this electronic circuitry.

The use of non-Nikon electronic accessories could damage the camera and may void your Nikon warranty. The use of third-party rechargeable Li-ion batteries not bearing the Nikon holographic seal shown at right could interfere with normal operation of the camera or result in the batteries overheating, igniting, rupturing, or leaking.

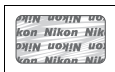

For more information about Nikon brand accessories, contact a local authorized Nikon dealer.

### **Before Taking Important Pictures**

Before taking pictures on important occasions (such as at weddings or before taking the camera on a trip), take a test shot to ensure that the camera is functioning normally. Nikon will not be held liable for damages or lost profits that may result from product malfunction.

### **Life-Long Learning**

As part of Nikon's "Life-Long Learning" commitment to ongoing product support and education, continually-updated information is available on-line at the following sites:

- **For users in the U.S.A.:** <http://www.nikonusa.com/>
- **For users in Europe and Africa:** <http://www.europe-nikon.com/support/>
- **For users in Asia, Oceania, and the Middle East:** <http://www.nikon-asia.com/>

Visit these sites to keep up-to-date with the latest product information, tips, answers to frequently-asked questions (FAQs), and general advice on digital imaging and photography. Additional information may be available from the Nikon representative in your area. See the following URL for contact information: <http://imaging.nikon.com/>



# Introduction

This chapter covers information you will need to know before using the camera, including the names of camera parts.



<b>Overview .....</b>	<b>2</b>
<b>Getting to Know the Camera .....</b>	<b>3</b>
Camera Body .....	3
The Control Panel .....	8
The Viewfinder Display .....	10
The Information Display .....	12
The BM-8 Monitor Cover .....	16

# Overview

Thank you for your purchase of a Nikon single-lens reflex (SLR) digital camera. Please be sure to read all instructions thoroughly to get the most from the camera, and keep them where they will be read by all those who use the product.



## Use Only Nikon Brand Accessories

Only Nikon brand accessories certified by Nikon specifically for use with your Nikon digital camera are engineered and proven to operate within its operational and safety requirements. THE USE OF NON-NIKON ACCESSORIES COULD DAMAGE YOUR CAMERA AND MAY VOID YOUR NIKON WARRANTY.

## Servicing the Camera and Accessories

The camera is a precision device and requires regular servicing. Nikon recommends that the camera be inspected by the original retailer or a Nikon-authorized service representative once every one to two years, and that it be serviced once every three to five years (note that fees apply to these services). Frequent inspection and servicing are particularly recommended if the camera is used professionally. Any accessories regularly used with the camera, such as lenses or optional flash units, should be included when the camera is inspected or serviced.

## Camera Settings

The explanations in this manual assume that default settings are used.





# Getting to Know the Camera

Take a few moments to familiarize yourself with camera controls and displays. You may find it helpful to bookmark this section and refer to it as you read through the rest of the manual.

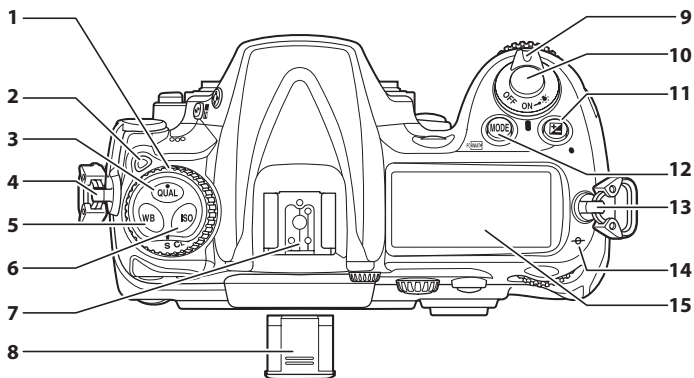

## Camera Body

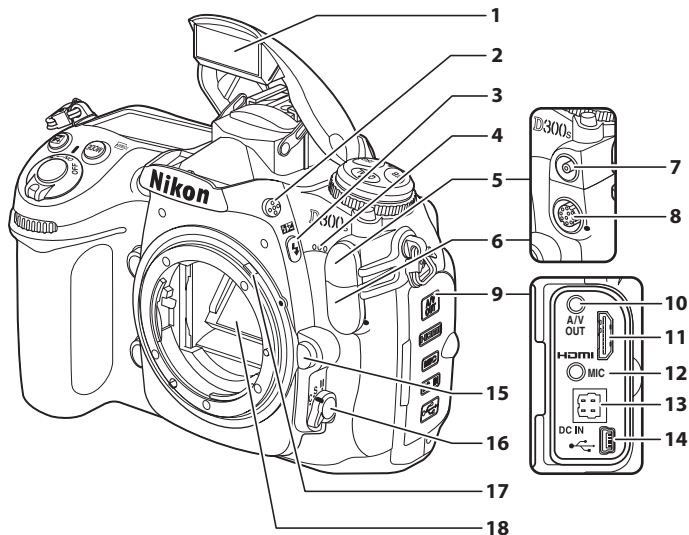

1	Release mode dial .....	87	8	BS-1 accessory shoe cover .....	347
2	Release mode dial lock release .....	87	9	Power switch .....	37, 39
3	QUAL (image quality/size) button .....	69, 71	10	Shutter-release button .....	43, 44
	Two-button reset button .....	182	11	 (exposure compensation) button .....	118
4	Eyelet for camera strap			Two-button reset button .....	182
5	WB (white balance) button .....	135, 140, 141	12	MODE (exposure mode) button .....	105
6	ISO (ISO sensitivity) button .....	96		 (format) button .....	34
7	Accessory shoe (for optional flash unit) .....	347	13	Eyelet for camera strap	
			14	Focal plane mark (-∞) .....	84
			15	Control panel .....	8

# Camera Body (Continued)



<b>1</b> Built-in flash .....	171	<b>10</b> A/V connector .....	239
<b>2</b> Flash pop-up button .....	171	<b>11</b> HDMI mini-pin connector .....	241
<b>3</b>  (flash mode) button.....	171	<b>12</b> Connector for external	
<b> (flash compensation)</b>		microphone .....	58, 62
button .....	177	<b>13</b> DC-IN connector for optional AC	
<b>4</b> Built-in microphone .....	59, 62	adapter EH-5a or EH-5 .....	352
<b>5</b> Flash sync terminal cover.....	347	<b>14</b> USB connector .....	225, 229
<b>6</b> Ten-pin remote terminal		<b>15</b> Lens release button .....	27
cover.....	198, 356	<b>16</b> Focus-mode selector .....	74, 83
<b>7</b> Flash sync terminal .....	347	<b>17</b> Meter coupling lever .....	387
<b>8</b> Ten-pin remote terminal ...	198, 356	<b>18</b> Mirror .....	93, 361
<b>9</b> Connector cover ....	225, 229, 239, 241		

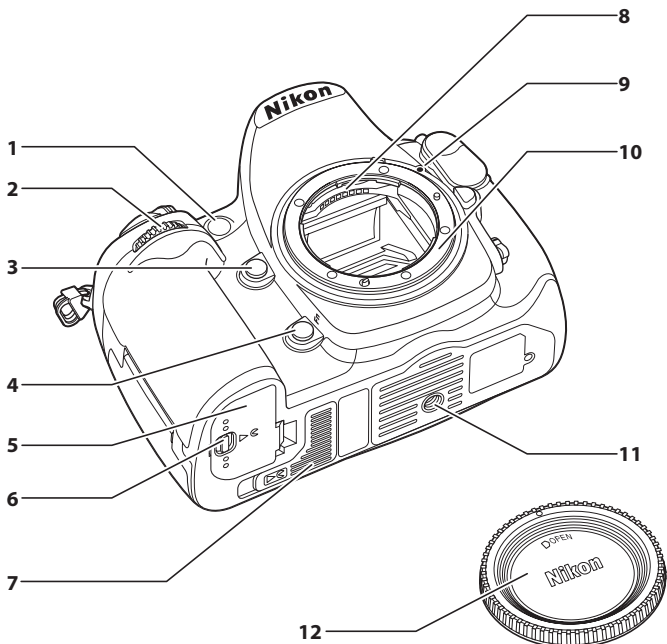

<p><b>1</b> AF-assist illuminator..... 268</p> <p>Self-timer lamp..... 92</p> <p>Red-eye reduction lamp..... 175</p>	<p><b>6</b> Battery-chamber cover latch..... 24</p> <p><b>7</b> Contact cover for optional MB-D10 battery pack ..... 352</p>
<p><b>2</b> Sub-command dial ..... 297</p>	<p><b>8</b> CPU contacts</p>
<p><b>3</b> Depth-of-field preview button ..... 105, 296</p>	<p><b>9</b> Mounting index ..... 27</p>
<p><b>4</b> Fn button .... 121, 125, 129, 179, 292</p>	<p><b>10</b> Lens mount..... 27, 84</p>
<p><b>5</b> Battery-chamber cover..... 24</p>	<p><b>11</b> Tripod socket</p> <p><b>12</b> BF-1A body cap ..... 26, 355</p>

### **✓ The Microphone and Speaker**

Do not place the microphone or speaker in close proximity to magnetic devices. Failure to observe this precaution could affect audio data recorded with the camera.

# Camera Body (Continued)

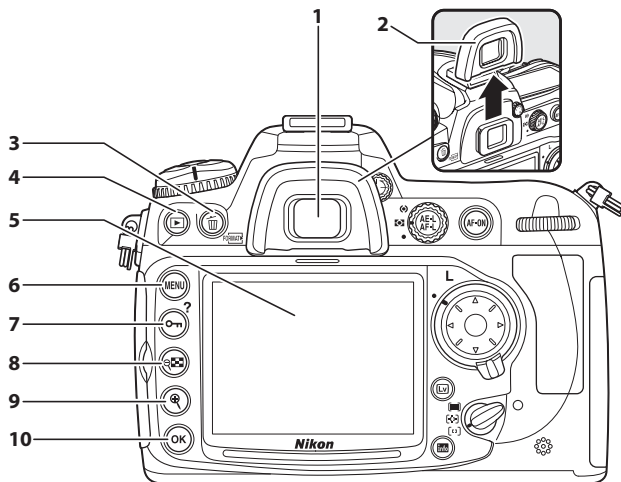

<b>1</b>	Viewfinder eyepiece.....	36	<b>7</b>	<b>O-m</b> (protect) button .....	219
<b>2</b>	DK-23 rubber eyecup .....	91, 191	<b>?</b>	(help) button .....	21
<b>3</b>	(delete) button .....	46, 220	<b>8</b>	(thumbnail/playback	
	(format) button.....	34		zoom out) button.....	216
<b>4</b>	(playback) button .....	45, 204	<b>9</b>	(playback zoom in)	
<b>5</b>	Monitor .....	45, 47, 204		button .....	218
<b>6</b>	<b>MENU</b> (menu) button .....	18, 243	<b>10</b>	(OK) button.....	19

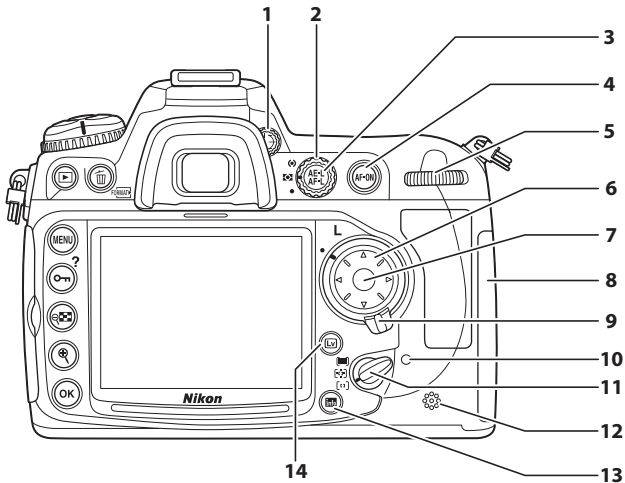

<b>1</b> Diopter adjustment control.....	36	<b>8</b> Memory card slot cover .....	31
<b>2</b> Metering selector.....	103	<b>9</b> Focus selector lock.....	78
<b>3</b> AE-L (AE/AF lock) button .....	80, 81, 296	<b>10</b> Memory card access lamp .....	33, 44
<b>4</b> AF-ON (AF-ON) button .....	50, 59, 75	<b>11</b> AF-area mode selector.....	76
<b>5</b> Main command dial .....	297	<b>12</b> Speaker .....	63, 64
<b>6</b> Multi selector .....	19	<b>13</b> info (info) button .....	12
<b>7</b> Multi selector center button .....	19, 59, 63, 291	<b>14</b> Live View (live view) button .....	49, 52, 58

# The Control Panel

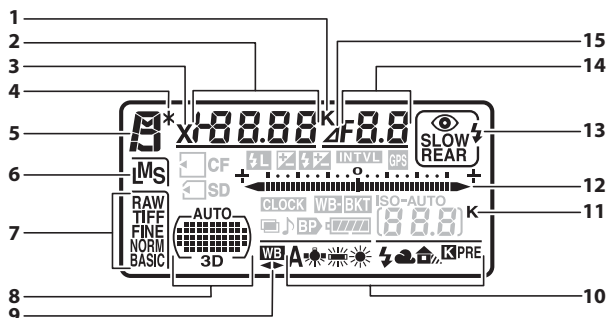

<b>1</b>	Color temperature indicator .....	141	<b>10</b>	White balance .....	135
<b>2</b>	Shutter speed .....	108, 112	<b>11</b>	"K" (appears when memory remains for over 1000 exposures) .....	38
	Exposure compensation value .....	118	<b>12</b>	Exposure indicator .....	113
	Flash compensation value .....	177		Exposure compensation indicator .....	118
	ISO sensitivity .....	96		Bracketing progress indicator: Exposure and flash bracketing ...	121
	White balance fine-tuning .....	140		WB bracketing .....	125
	Color temperature .....	141		ADL bracketing .....	129
	White balance preset number .....	151		PC connection indicator .....	224
	Number of shots in exposure, flash, or white balance bracketing sequence .....	121, 125	<b>13</b>	Flash mode .....	171
	Number of intervals for interval timer photography .....	192	<b>14</b>	Aperture (f-number) .....	109, 112
	Focal length (non-CPU lenses) .....	197		Aperture (number of stops) ...	110, 343
<b>3</b>	Flash sync indicator .....	281		Bracketing increment .....	122, 126
<b>4</b>	Flexible program indicator .....	107		Number of shots in ADL bracketing sequence .....	129
<b>5</b>	Exposure mode .....	104		Number of shots per interval .....	192
<b>6</b>	Image size .....	71		Maximum aperture (non-CPU lenses) .....	197
<b>7</b>	Image quality .....	69		PC mode indicator .....	224
<b>8</b>	Auto-area AF indicator .....	77	<b>15</b>	Aperture stop indicator .....	110, 343
	AF-area mode indicator .....	77			
	3D-tracking indicator .....	77, 265			
<b>9</b>	White balance fine-tuning indicator .....	140			

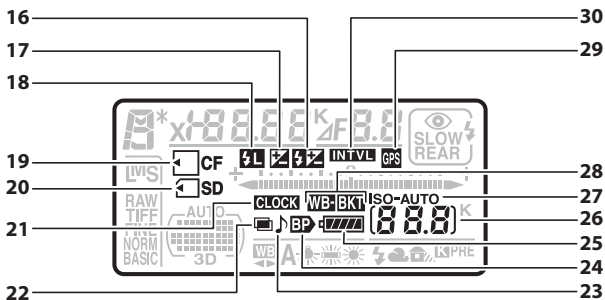

<b>16</b>	Flash compensation indicator .....	177	<b>26</b>	Number of exposures remaining ...	38
<b>17</b>	Exposure compensation indicator .....	118		Number of shots remaining before memory buffer fills .....	89
<b>18</b>	FV lock indicator .....	179		Capture mode indicator .....	224
<b>19</b>	CompactFlash (CF) card indicator .....	32		Preset white balance recording indicator .....	144
<b>20</b>	Secure Digital (SD) card indicator .....	32	<b>27</b>	Manual lens number .....	197
<b>21</b>	"Clock not set" indicator .....	30, 378		ISO sensitivity indicator .....	96
<b>22</b>	Multiple exposure indicator .....	186		Auto ISO sensitivity indicator .....	99
<b>23</b>	"Beep" indicator .....	275	<b>28</b>	Exposure and flash bracketing indicator .....	121
<b>24</b>	MB-D10 battery indicator .....	280		WB bracketing indicator .....	125
<b>25</b>	Battery indicator .....	37		ADL bracketing indicator .....	129
			<b>29</b>	GPS connection indicator .....	200
			<b>30</b>	Interval timer indicator .....	192

# The Viewfinder Display

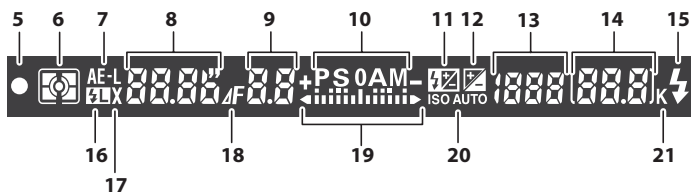
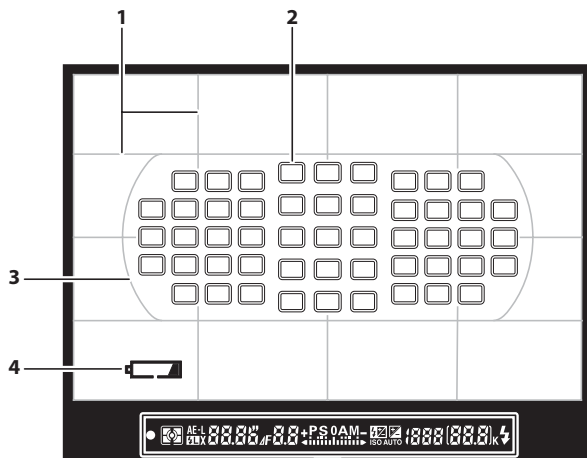



<p><b>1</b> Framing grid (displayed when <b>On</b> is selected for Custom Setting d2) ..... 275</p> <p><b>2</b> Focus points ..... 78, 267</p> <p><b>3</b> AF area brackets ..... 36, 52</p> <p><b>4</b> Battery indicator ..... 37, 275 (display can be turned off with Custom Setting d3)</p> <p><b>5</b> Focus indicator ..... 43, 84</p> <p><b>6</b> Metering ..... 102</p> <p><b>7</b> Autoexposure (AE) lock ..... 116</p> <p><b>8</b> Shutter speed ..... 108, 112</p> <p><b>9</b> Aperture (f-number) ..... 109, 112 Aperture (number of stops) ..... 110</p> <p><b>10</b> Exposure mode ..... 104</p> <p><b>11</b> Flash compensation indicator ..... 177</p> <p><b>12</b> Exposure compensation indicator ..... 118</p> <p><b>13</b> ISO sensitivity ..... 96</p>	<p><b>14</b> Number of exposures remaining ..... 38 Number of shots remaining before memory buffer fills ..... 43, 89 White balance recording indicator ..... 144 Exposure compensation value ..... 118 Flash compensation value ..... 177</p> <p><b>15</b> Flash-ready indicator ..... 171</p> <p><b>16</b> FV lock indicator ..... 179</p> <p><b>17</b> Flash sync indicator ..... 281</p> <p><b>18</b> Aperture stop indicator ..... 110</p> <p><b>19</b> Exposure indicator ..... 113 Exposure compensation display ..... 118</p> <p><b>20</b> Auto ISO sensitivity indicator ..... 99</p> <p><b>21</b> "K" (appears when memory remains for over 1000 exposures) ..... 38</p>
---	--



**✓ No Battery**

When the battery is totally exhausted or no battery is inserted, the display in the viewfinder will dim. This is normal and does not indicate a malfunction. The viewfinder display will return to normal when a fully-charged battery is inserted.

**✓ The Control Panel and Viewfinder Displays**

The brightness of the control panel and viewfinder displays varies with temperature, and the response times of the displays may drop at low temperatures. This is normal and does not indicate a malfunction.

## The Information Display

Shooting information, including shutter speed, aperture, the number of exposures remaining, buffer capacity, and AF-area mode, is displayed in the monitor when the **info** button is pressed.

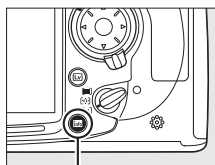



**info** button

### Turning the Monitor Off

To clear shooting information from the monitor, press the **info** button twice more or press the shutter-release button halfway. The monitor will turn off automatically if no operations are performed for about 10 seconds. The information display can be restored by pressing the **info** button.

### See Also

For information on choosing how long the monitor stays on, see Custom Setting c4 (**Monitor off delay**,  274). For information on changing the color of the lettering in the information display, see Custom Setting d8 (**Information display**,  278).

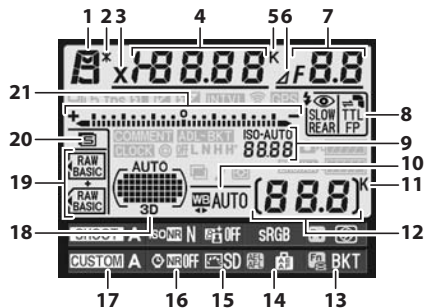

<b>1</b> Exposure mode .....	104	<b>11</b> "K" (appears when memory remains for over 1000 exposures).....	38
<b>2</b> Flexible program indicator.....	107	<b>12</b> Number of exposures remaining .....	38
<b>3</b> Flash sync indicator.....	281	Manual lens number .....	197
<b>4</b> Shutter speed .....	108, 111	<b>13</b> Fn button assignment .....	292
Exposure compensation value .....	118	<b>14</b> AE-L/AF-L button assignment .....	296
Flash compensation value.....	177	<b>15</b> Picture Control indicator .....	155
Number of shots in exposure, flash, or white balance bracketing sequence .....	121, 125	<b>16</b> Long exposure noise reduction indicator .....	258
Focal length (non-CPU lenses) .....	197	<b>17</b> Custom settings bank .....	262
Color temperature.....	141	<b>18</b> Auto-area AF indicator.....	77
<b>5</b> Color temperature indicator.....	141	Focus points indicator .....	78
<b>6</b> Aperture stop indicator.....	110	AF-area mode indicator.....	77
<b>7</b> Aperture (f-number) .....	109, 111	3D-tracking indicator .....	77, 265
Aperture (number of stops) .....	110	<b>19</b> Image quality .....	68
Bracketing increment.....	122, 126	Primary/secondary slot.....	72
Number of shots in ADL bracketing sequence .....	129	<b>20</b> Image size .....	71
Maximum aperture (non-CPU lenses) .....	197	<b>21</b> Exposure indicator .....	113
<b>8</b> Flash mode.....	171	Exposure compensation indicator .....	118
<b>9</b> ISO sensitivity indicator .....	96	Bracketing progress indicator: Exposure and flash bracketing... WB bracketing.....	121 125
Auto ISO sensitivity indicator .....	99	ADL bracketing .....	129
<b>10</b> White balance.....	134		
White balance fine-tuning indicator.....	140		

## The Information Display (Continued)

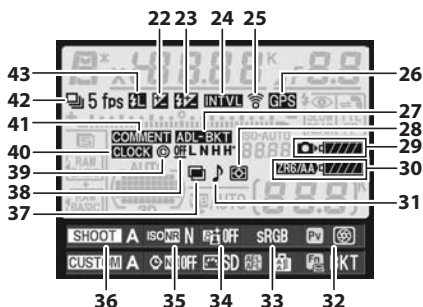

<b>22</b> Exposure compensation display ..... 118	<b>32</b> Depth-of-field preview button assignment .....296
<b>23</b> Flash compensation indicator ..... 177	<b>33</b> Color space indicator ..... 166
<b>24</b> Interval timer indicator ..... 192	<b>34</b> Active D-Lighting indicator ..... 165
<b>25</b> Eye-Fi connection indicator ..... 313	<b>35</b> High ISO noise reduction indicator .....259
<b>26</b> GPS connection indicator ..... 200	<b>36</b> Shooting menu bank .....254
<b>27</b> Exposure and flash bracketing indicator ..... 121	<b>37</b> Multiple exposure indicator ..... 186
WB bracketing indicator ..... 125	<b>38</b> ADL bracketing amount ..... 130
ADL bracketing indicator ..... 129	<b>39</b> Copyright information .....309
<b>28</b> Metering ..... 102	<b>40</b> "Clock not set" indicator ..... 30, 378
<b>29</b> Camera battery indicator .....37	<b>41</b> Image comment indicator .....303
<b>30</b> MB-D10 battery type display ..... 280	<b>42</b> Release mode (single frame/continuous) indicator .....86
MB-D10 battery indicator ..... 279	Continuous shooting speed .....88
<b>31</b> "Beep" indicator ..... 275	<b>43</b> FV lock indicator ..... 179

## ■ Changing Settings in the Information Display

To change settings for the items listed below, press the **Info** button in the information display. Highlight items using the multi selector and press **OK** to view options for the highlighted item.

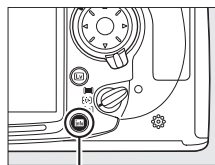

**Info** button

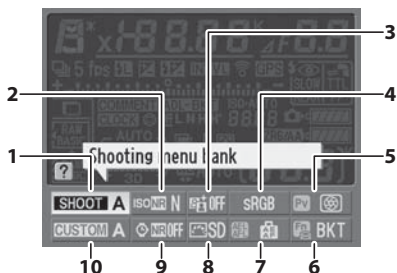

<b>1</b> Shooting menu bank.....	254	<b>6</b> Fn button assignment.....	292
<b>2</b> High ISO noise reduction.....	259	<b>7</b> AE-L/AF-L button assignment.....	296
<b>3</b> Active D-Lighting.....	164	<b>8</b> Picture Control.....	154
<b>4</b> Color space.....	166	<b>9</b> Long exposure noise reduction .....	258
<b>5</b> Depth-of-field preview button assignment.....	296	<b>10</b> Custom settings bank.....	262

### Tool Tips

A tool tip giving the name of the selected item appears in the information display. Tool tips can be turned off using Custom Setting d4 (**Screen tips**; 276).

### Viewing Button Assignments

, **Fn**, and icons indicate the “button press” function ( 292, 296) performed respectively by the depth-of-field preview button, **Fn** button, and **AE-L/AF-L** button. The “button+dials” functions ( 295) are indicated by , **Fn**, and icons. If separate functions have been assigned to “button press” and “button + dials,” the latter assignment can be viewed by pressing the button.

## The BM-8 Monitor Cover

A clear plastic cover is provided with the camera to keep the monitor clean and protect it when the camera is not in use. To attach the cover, insert the projection on the top of the cover into the matching indentation above the camera monitor (①) and press the bottom of the cover until it clicks into place (②).

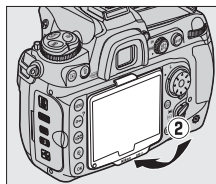
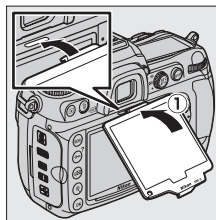

To remove the cover, hold the camera firmly and pull the bottom of the cover gently outwards as shown at right.

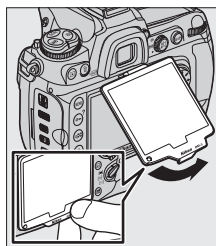



# Tutorial

This section describes how to use the camera menus, how to ready the camera for use, and how to take your first pictures and play them back.



<b>Camera Menus .....</b>	<b>18</b>
Using Camera Menus .....	19
Help .....	21
<b>First Steps .....</b>	<b>22</b>
Charge the Battery .....	22
Insert the Battery .....	24
Attach a Lens .....	26
Basic Setup .....	28
Insert a Memory Card .....	31
Format the Memory Card .....	34
Adjust Viewfinder Focus .....	36
<b>Basic Photography and Playback .....</b>	<b>37</b>
Turn the Camera On .....	37
Adjust Camera Settings .....	40
Ready the Camera .....	42
Focus and Shoot .....	43
Viewing Photographs .....	45
Deleting Unwanted Photographs .....	46

# Camera Menu

Most shooting, playback, and setup options can be accessed from the camera menu. To view the menus, press the **MENU** button.

## MENU button

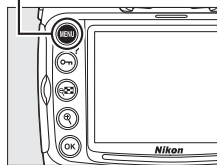

## Tabs

Choose from the following menus:

- **Playback** (📖 244)
- **Shooting** (📖 253)
- **Custom Settings** (📖 260)
- **Setup** (📖 300)
- **Retouch** (📖 315)
- **My Menu or Recent settings** (defaults to **My Menu**; 📖 333)

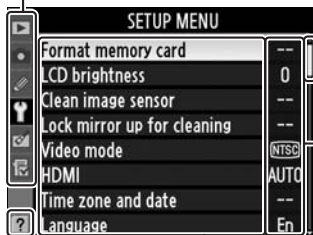

Slider shows position in current menu.

Current settings are shown by icons.

## Menu options

Options in current menu.



If icon is displayed, help for current item can be viewed by pressing button (📖 21).



# Using Camera Menus

## Menu Controls

The multi selector and **OK** button are used to navigate the menus.

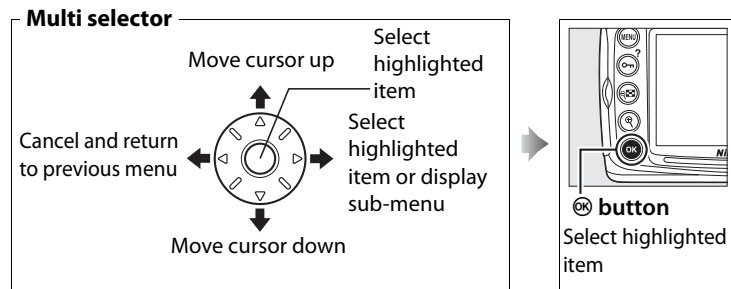

## Navigating the Menus

Follow the steps below to navigate the menus.

### 1 Display the menus.

Press the **MENU** button to display the menus.

#### MENU button

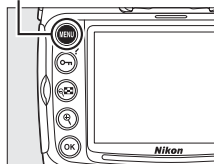

### 2 Highlight the icon for the current menu.

Press **◀** to highlight the icon for the current menu.

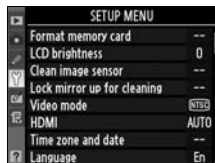

### 3 Select a menu.

Press ▲ or ▼ to select the desired menu.

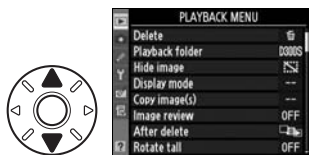

### 4 Position the cursor in the selected menu.

Press ► to position the cursor in the selected menu.

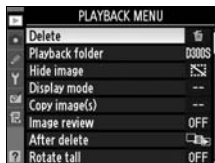

### 5 Highlight a menu item.

Press ▲ or ▼ to highlight a menu item.

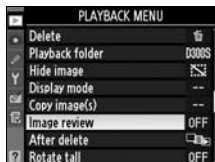

### 6 Display options.

Press ► to display options for the selected menu item.



### 7 Highlight an option.

Press ▲ or ▼ to highlight an option.



## 8 Select the highlighted item.

Press **OK** to select the highlighted item. To exit without making a selection, press the **MENU** button.

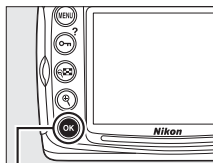

**OK** button

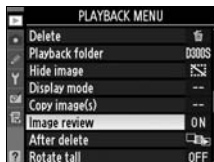

Note the following points:

- Menu items that are displayed in gray are not currently available.
- While pressing **▶** or the center of the multi selector generally has the same effect as pressing **OK**, there are some cases in which selection can only be made by pressing **OK**.
- To exit the menus and return to shooting mode, press the shutter-release button halfway (□ 44).

## Help

If a **?** icon is displayed at the bottom left corner of the monitor, help can be displayed by pressing the **Fn (?)** button.



A description of the currently selected option or menu will be displayed while the button is pressed. Press **▲** or **▼** to scroll through the display.

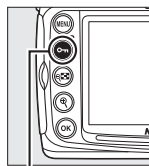

**Fn (?)** button

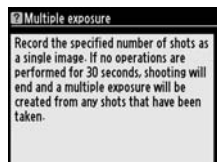

# First Steps

## Charge the Battery

The D300S is powered by an EN-EL3e rechargeable Li-ion battery (supplied). To maximize shooting time, charge the battery in the supplied MH-18a quick charger before use. About two and a quarter hours are required to fully recharge the battery when no charge remains.



### **1** Plug the charger in.

Insert the AC adapter plug into the battery charger and plug the power cable into an electrical outlet.

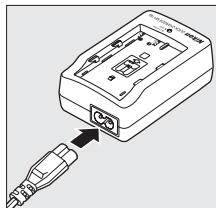

### **2** Remove the terminal cover.

Remove the terminal cover from the battery.

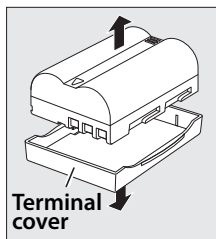

### 3 Insert the battery.

Insert the battery into the charger. The CHARGE lamp will blink while the battery charges.

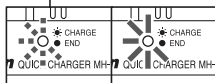
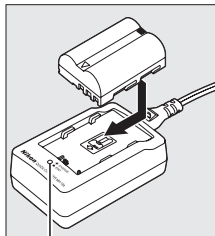

**Battery charging**      **Charging complete**

### 4 Remove the battery when charging is complete.

Charging is complete when the CHARGE lamp stops blinking. Remove the battery and unplug the charger.

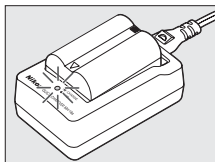

# Insert the Battery

- 1 Turn the camera off.

Power switch

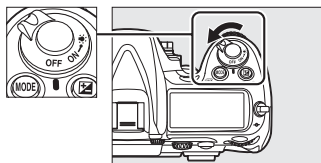

## Inserting and Removing Batteries

Always turn the camera off before inserting or removing batteries.

- 2 Open the battery-chamber cover.

Unlatch (1) and open (2) the battery-chamber cover.

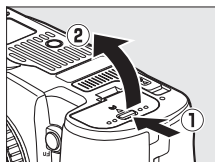

- 3 Insert the battery.

Insert the battery as shown at right.

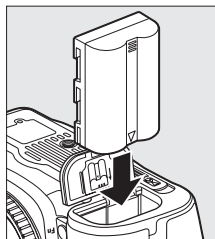

- 4 Close the battery-chamber cover.

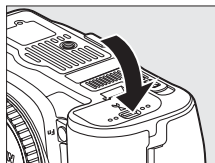

## **The Battery and Charger**

*Read and follow the warnings and cautions on pages xviii–xx and 364–367 of this manual.* To prevent short-circuits, replace the terminal cover when the battery is not in use.

Do not use the battery at ambient temperatures below 0°C (32°F) or above 40°C (104°F). Charge indoors at ambient temperatures in the vicinity of 5–35°C (41–95°F); for best results, charge the battery at temperatures above 20°C (68°F). Battery capacity may temporarily drop if the battery is charged at low temperatures or used at a temperature below the temperature at which it was charged. If the battery is charged at a temperature below 5°C (41°F), the battery life indicator in the **Battery info** (☞ 307) display may show a temporary decrease.

The battery may be hot immediately after use. Wait for the battery to cool before recharging.

Use the charger with compatible batteries only. Unplug when not in use.

## **Incompatible Batteries**

The D300S can not be used with EN-EL3 or EN-EL3a rechargeable Li-ion batteries for the D100, D70 series, or D50 or with the MS-D70 CR2 battery holder.

## **EN-EL3e Rechargeable Li-ion Batteries**

The supplied EN-EL3e shares information with compatible devices, enabling the camera to show battery charge state in six levels (☞ 37). The **Battery info** option in the setup menu details battery charge, battery life, and the number of pictures taken since the battery was last charged (☞ 307).



# Attach a Lens

Care should be taken to prevent dust from entering the camera when the lens is removed. An AF-S DX VR Zoom-Nikkor 18–200mm f/3.5–5.6G IF-ED lens is used in this manual for illustrative purposes.

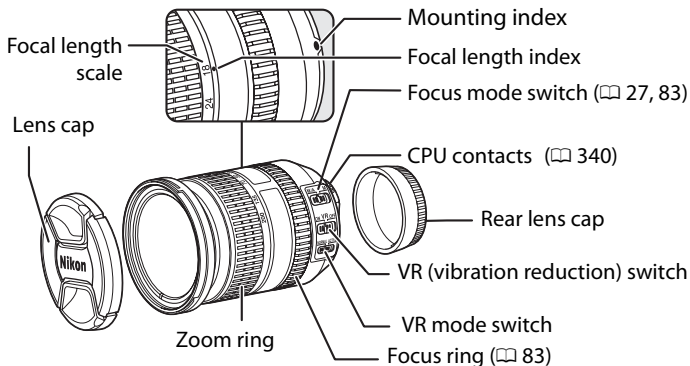

---

**1** Turn the camera off.

---

**2** Remove the rear lens cap and the camera body cap.

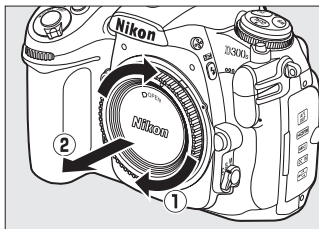
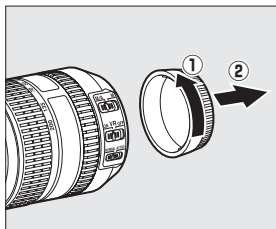



### 3 Attach the lens.

Keeping the mounting index on the lens aligned with the mounting index on the camera body, position the lens in the camera's bayonet mount (①). Being careful not to press the lens-release button, rotate the lens counter-clockwise until it clicks into place (②).

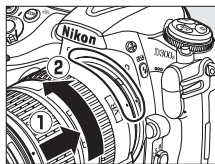

Mounting index

If the lens is equipped with an **A-M** or **M/A-M** switch, select **A** (autofocus) or **M/A** (autofocus with manual priority).

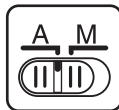

#### ■■ Detaching the Lens

Be sure the camera is off when removing or exchanging lenses. To remove the lens, press and hold the lens release button (①) while turning the lens clockwise (②). After removing the lens, replace the lens caps and camera body cap.

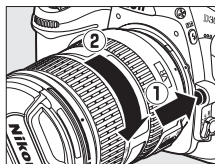

#### ✓ CPU Lenses with Aperture Rings

In the case of CPU lenses equipped with an aperture ring (☐ 340), lock aperture at the minimum setting (highest f-number).

# Basic Setup

The language option in the setup menu is automatically highlighted the first time menus are displayed. Choose a language and set the time and date. Note that if the time and date are not set, **CLOCK** will blink in the monitor and the time and date recorded with photographs will be incorrect.

## 1 Turn the camera on.

### Power switch

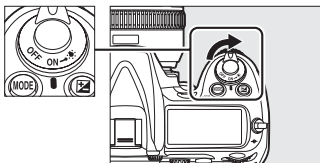

## 2 Select Language.

Press **MENU** to display the camera menus, then select **Language** in the setup menu. For information on using menus, see “Using Camera Menus” (□ 19).

### MENU button

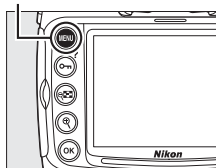

## 3 Select a language.

Press **▲** or **▼** to highlight the desired language and press **OK**.



## 4 Select Time zone and date.

Select **Time zone and date** and press ►.



## 5 Set time zone.

Select **Time zone** and press ►. Press ◀ or ▶ to highlight the local time zone (the **UTC** field shows the difference between the selected time zone and Coordinated Universal Time, or UTC, in hours) and press Ⓚ.

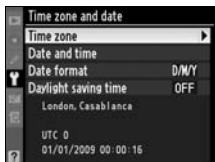

## 6 Turn daylight saving time on or off.

Select **Daylight saving time** and press ►. Daylight saving time is off by default; if daylight saving time is in effect in the local time zone, press ▲ to highlight **On** and press Ⓚ.

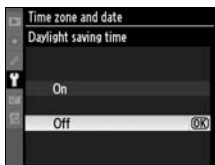

## 7 Set the date and time.

Select **Date and time** and press ►. Press ◀ or ▶ to select an item, ▲ or ▼ to change. Press Ⓚ when the clock is set to the current date and time.



## 8 Set date format.

Select **Date format** and press **▶**. Press **▲** or **▼** to choose the order in which the year, month, and day will be displayed and press **OK**.

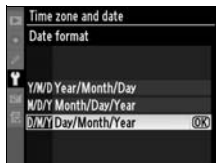

## 9 Exit to shooting mode.

Press the shutter-release button halfway to exit to shooting mode.



### **The Clock Battery**

The camera clock is powered by an independent, rechargeable power source, which is charged as necessary when the main battery is installed or the camera is powered by an optional EH-5a or EH-5 AC adapter (☞ 352). Two days of charging will power the clock for about three months. If the **CLOCK** icon flashes in the control panel, the clock battery is exhausted and the clock has been reset. Set the clock to the correct time and date.

### **The Camera Clock**

The camera clock is less accurate than most watches and household clocks. Check the clock regularly against more accurate time pieces and reset as necessary.

# Insert a Memory Card

The camera has two memory card slots, one for Type I CompactFlash memory cards (Type II cards and microdrives can not be used) and another for Secure Digital (SD) memory cards (memory cards are available separately; 393). The following section describes how to insert and format a memory card.

## 1 Turn the camera off.

Power switch

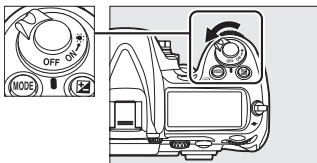

### Inserting and Removing Memory Cards

Always turn the camera off before inserting or removing memory cards.

## 2 Open the card slot cover.

Slide the card slot cover out (1) and open the card slot (2).

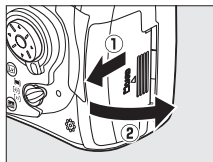

## 3 Insert the memory card.

**CompactFlash memory cards:** Insert the card into the CompactFlash card slot with the front label toward the monitor (1). When the memory card is fully inserted, the eject button will pop up (2) and the green access lamp will light briefly.

CompactFlash  
card slot

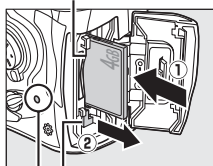

Eject button

Access lamp

**SD memory cards:** Holding the card as shown, slide it into the SD card slot until it clicks into place. The green access lamp will light briefly.

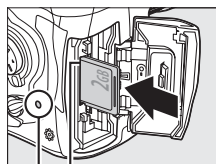

SD card slot

Access lamp

#### Inserting Memory Cards

Inserting memory cards upside down or backwards could damage the camera or the card. Check to be sure that the card is in the correct orientation.

If this is the first time the memory card will be used after being used or formatted in another device, format the card as described on page 34.

## 4 Close the card slot cover.

#### Using Two Memory Cards

See page 72 for information on choosing the roles played by each card when two cards are inserted in the camera.

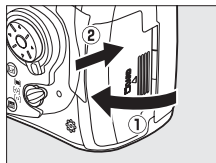

#### Memory Card Icons

The memory cards currently inserted in the camera are indicated as shown (the example at right shows the icons displayed when both a CompactFlash and an SD card are inserted). If the memory card is full or locked or an error has occurred, the icon for the affected card will blink (☐ 381).

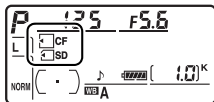

Control panel



Information display

## ■ ■ Removing Memory Cards

### 1 Turn the camera off.

Confirm that the access lamp is off and turn the camera off.

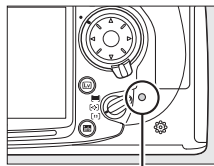

Access lamp

### 2 Remove the memory card.

**CompactFlash memory cards:** Open the memory card slot cover and press the eject button (①) to partially eject the card (②). The memory card can then be removed by hand. Do not push on the memory card while pressing the eject button. Failure to observe this precaution could damage the camera or memory card.

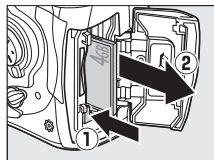

**SD memory cards:** Open the memory card slot cover and press the card in to eject it (①). The memory card can then be removed by hand (②).

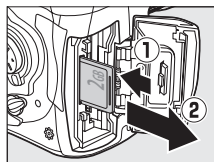

# Format the Memory Card

Memory cards must be formatted before first use or after being used or formatted in other devices.

## ✔ Formatting Memory Cards





*Formatting memory cards permanently deletes any data they may contain.*

Be sure to copy any photographs and other data you wish to keep to a computer before proceeding (📖 224).



### 1 Turn the camera on.



### 2 Press the buttons.

Hold the  (MODE and ) buttons down simultaneously until a blinking **F o r** appears in the shutter-speed displays in the control panel and viewfinder. If two memory cards are inserted, the primary card slot (📖 72) will be selected; you can choose the secondary slot by rotating the main command dial. To exit without formatting the memory card, wait until **F o r** stops blinking (about six seconds) or press any button other than the  (MODE and ) buttons.

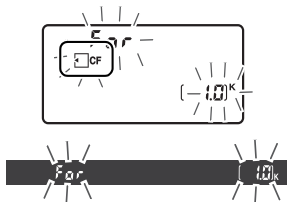
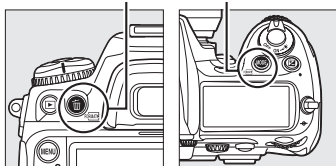
 button    MODE button



### 3 Press the buttons again.

Press the  (MODE and ) buttons together a second time while **F o r** is blinking to format the memory card. *Do not remove the memory card or remove or disconnect the power source during formatting.*



When formatting is complete, the control panel and viewfinder will show the number of photographs that can be recorded at current settings.

### ✓ Memory Cards

- Memory cards may be hot after use. Observe due caution when removing memory cards from the camera.
- Turn the power off before inserting or removing memory cards. Do not remove memory cards from the camera, turn the camera off, or remove or disconnect the power source during formatting or while data are being recorded, deleted, or copied to a computer. Failure to observe these precautions could result in loss of data or in damage to the camera or card.
- Do not touch the card terminals with your fingers or metal objects.
- Do not bend, drop, or subject to strong physical shocks.
- Do not apply force to the card casing. Failure to observe this precaution could damage the card.
- Do not expose to water, high levels of humidity, or direct sunlight.

### ✎ The Write Protect Switch

SD memory cards are equipped with a write protect switch to prevent accidental loss of data. When this switch is in the “lock” position, photos can not be recorded or deleted and the memory card can not be formatted. To unlock the memory card, slide the switch to the “write” position.

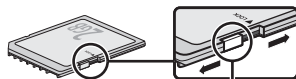

Write-protect switch

### ✎ No Memory Card

If no memory card is inserted, the control panel and viewfinder will show [-E-]. If the camera is turned off with a charged EN-EL3e battery and no memory card inserted, [-E-] will be displayed in the control panel.

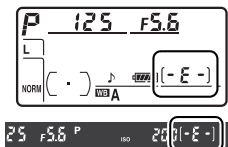

### ✎ See Also

See page 301 for information on formatting memory cards using the **Format memory card** option in the setup menu.



# Adjust Viewfinder Focus

The camera is equipped with diopter adjustment to accommodate individual differences in vision. Check that the display in the viewfinder is in focus before shooting.

## 1 Turn the camera on.

Remove the lens cap and turn the camera on.

Power switch

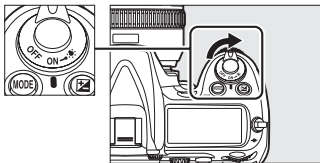

## 2 Focus the viewfinder.

Rotate the diopter control until the viewfinder display, focus points, and AF area brackets are in sharp focus. When operating the diopter control with your eye to the viewfinder, be careful not to put your fingers or fingernails in your eye.

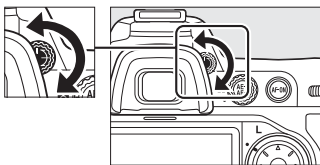

AF area brackets

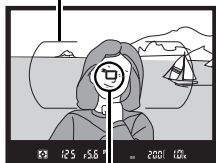

Focus point

### Adjusting Viewfinder Focus

If you are unable to focus the viewfinder as described above, rotate the AF-area mode selector to  $[^*]$  (single-point AF) and the focus mode selector to  $S$ , then frame a high-contrast subject in the center focus point and focus using autofocus. With the camera in focus, rotate the diopter control until the subject is clearly focused in the viewfinder. If necessary, viewfinder focus can be further adjusted using optional corrective lenses (☞ 353).

# Basic Photography and Playback

## Turn the Camera On

Before taking photographs, turn the camera on and check the battery level and number of exposures remaining as described below.

### 1 Turn the camera on.

Turn the camera on. The control panel will turn on and the display in the viewfinder will light.

Power switch

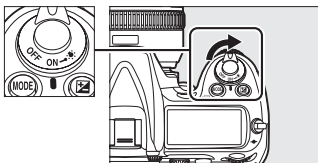

### 2 Check the battery level.

Check the battery level in the control panel or viewfinder.

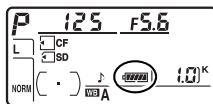

Icon*		Description
Control panel	Viewfinder	
	—	Battery fully charged.
	—	Battery partially discharged.
	—	
	—	
		Low battery. Prepare to charge battery or ready spare battery.
 (blinks)	 (blinks)	Shutter release disabled. Charge or exchange battery.

\* No icon displayed when camera is powered by optional AC adapter.

### 3 Check the number of exposures remaining.

The exposure-count displays in the control panel and viewfinder show the number of photographs that can be taken at current settings (if two memory cards are inserted, the displays show the space available on the card in the primary slot; [72](#)).

When this number reaches zero,  will flash in the exposure-count displays while the shutter-speed displays will show a blinking **FuLL** or **FuL** and the icon for the affected card will blink.

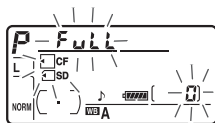
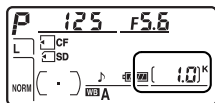

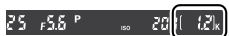
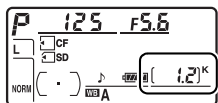

#### Large-Capacity Memory Cards

When enough memory remains on the memory card to record a thousand or more pictures at current settings, the number of exposures remaining will be shown in thousands, rounded down to the nearest hundred (e.g., if there is room for approximately 1,260 exposures, the exposure count display will show 1.2 K).



## LCD Illuminators

Rotating the power switch toward  activates the exposure meters and the control panel backlight (LCD illuminator), allowing the display to be read in the dark. After the power switch is released, the illuminators will remain lit for six seconds while the exposure meters are active or until the shutter is released or the power switch is rotated toward  again.

## Power switch

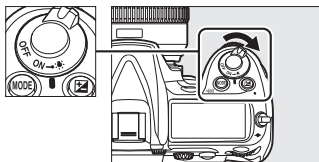

## Auto Meter Off

The shutter speed and aperture displays in the control panel and viewfinder will turn off if no operations are performed for about six seconds (auto meter off), reducing the drain on the battery. Press the shutter-release button halfway to reactivate the display in the viewfinder ( 44).

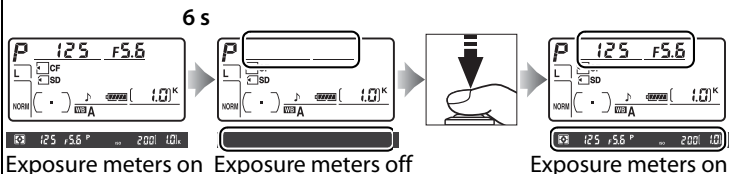

The length of time before the exposure meters turn off automatically can be adjusted using Custom Setting c2 (**Auto meter-off delay**,  273).

## Camera Off Display

If the camera is turned off with a battery and memory card inserted, the memory card icon and number of exposures remaining will be displayed (some memory cards may in rare cases only display this information when the camera is on).

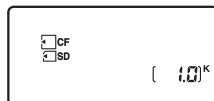

## Control panel

# Adjust Camera Settings

This tutorial describes the basic steps involved in taking photos.

## 1 Choose exposure mode *P*.

Press the **MODE** button and rotate the main command dial to select exposure mode *P*. The camera will automatically adjust shutter speed and aperture for optimal exposure in most situations.

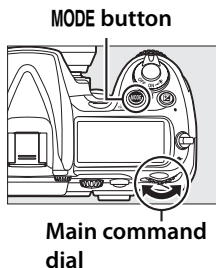

## 2 Choose single frame release mode.

Hold the release mode dial lock release down and turn the release mode dial to *S* (single frame). At this setting, the camera will take one photograph each time the shutter-release button is pressed.

Release mode dial lock release

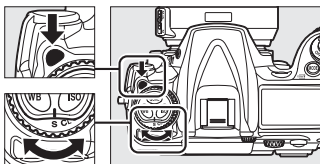

Release mode dial

## 3 Choose single-point AF.

Rotate the AF-area mode selector until it clicks into place pointing to [*\*1*] (single-point AF). At this setting, the user can choose the focus point.

AF-area mode selector

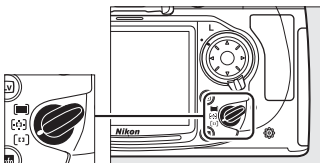

## 4 Choose single-servo autofocus.

Rotate the focus-mode selector until it clicks into place pointing to **S** (single-servo autofocus). At this setting, the camera will automatically focus on the subject in the selected focus point when the shutter-release button is pressed halfway. Pictures can only be taken when the camera is in focus.

### Focus-mode selector

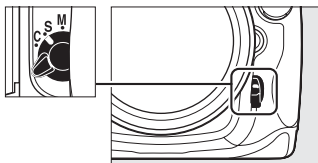

## 5 Choose matrix metering.

Rotate the metering selector to  (matrix metering). Matrix metering uses information from the 1,005-pixel RGB sensor to ensure optimal results for the entire frame.

### Metering selector

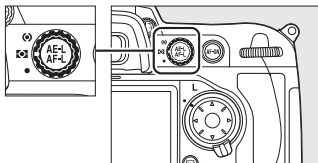

## 6 Check camera settings.

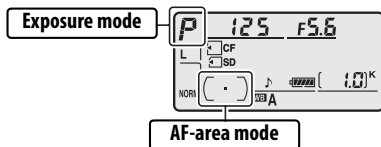

Control panel



Viewfinder display

## Ready the Camera

When framing photographs in the viewfinder, hold the handgrip in your right hand and cradle the camera body or lens with your left. Keep your elbows propped lightly against your torso for support and place one foot half a pace ahead of the other to keep your upper body stable.



Hold the camera as shown at right when framing photographs in portrait (tall) orientation.

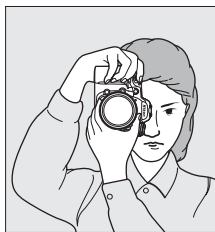
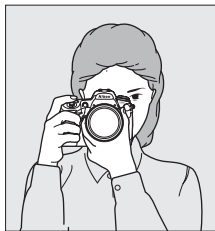



# Focus and Shoot

## 1 Press the shutter-release button halfway to focus (📖 44).

At default settings, the camera will focus on the subject in the center focus point. Frame a photo in the viewfinder with the main subject positioned in the center

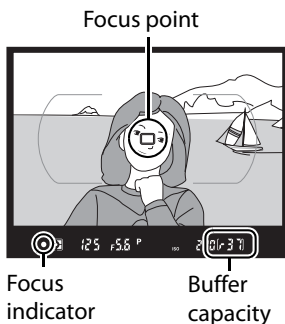

focus point and press the shutter-release button halfway. If the camera is able to focus, a beep will sound and the in-focus indicator (●) will appear in the viewfinder. If the subject is dark, the AF-assist illuminator may light automatically to assist the focus operation.

Viewfinder display	Description
●	Subject in focus.
● (blinks)	Camera unable to focus on subject in focus point using autofocus.

While the shutter-release button is pressed halfway, focus will lock and the number of exposures that can be stored in the memory buffer ("r"; 📖 89) will be shown in the viewfinder display.



For information on what to do if the camera is unable to focus using autofocus, see "Getting Good Results with Autofocus" (📖 82).

## 2 Press the shutter-release button the rest of the way down to shoot.

Smoothly press the shutter-release-button the rest of the way down to take the picture.

While the photograph is being recorded to the memory card, the access lamp next to the card slot cover will light. *Do not eject the memory card or remove or disconnect the power source until the lamp has gone out.*

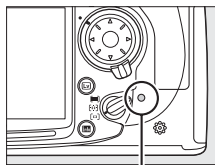

Access lamp



### The Shutter-Release Button

The camera has a two-stage shutter-release button. The camera focuses when the shutter-release button is pressed halfway. To take the photograph, press the shutter-release button the rest of the way down.



Focus



Take photograph

# Viewing Photographs



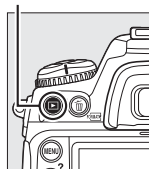

## 1 Press the button.

A photograph will be displayed in the monitor. The memory card containing the picture currently displayed is shown by an icon.

 button



## 2 View additional pictures.

Additional pictures can be displayed by pressing  or . To view additional information on the current photograph, press  and  (see page 207).

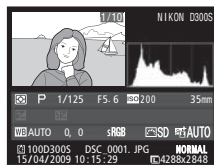

To end playback and return to shooting mode, press the shutter-release button halfway.

### **Image Review**

When **On** is selected for **Image review** in the playback menu (see page 251), photographs are automatically displayed in the monitor for about 4 s after shooting.

### **See Also**

See page 217 for information on choosing a memory card slot.

# Deleting Unwanted Photographs

To delete the photograph currently displayed in the monitor, press the  button. Note that photographs can not be recovered once deleted.

## 1 Display the photograph.



Display the photograph you wish to delete as described in “Viewing Photographs” on the previous page.

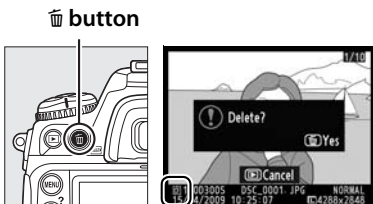

## 2 Delete the photograph.

Press the  button. A confirmation dialog will be displayed (the location of the current picture is shown by the icon in the bottom left corner of the dialog).



Press the  button again to delete the image and return to playback. To exit without deleting the picture, press .

### Delete

To delete multiple images or to select the memory card from which images will be deleted, use the **Delete** option in the playback menu (☰ 221).



# Framing Pictures in the Monitor (Live View)





This chapter describes how to frame pictures in the monitor using live view.



**Framing Photographs in the Monitor ..... 48**

# Framing Photographs in the Monitor

Press the  button to frame pictures in the monitor. The following options are available:

- **Tripod** (): Choose when the camera is mounted on a tripod ( 49). You can zoom in on the image displayed in the monitor for precise focus, making this option suitable for static subjects. Contrast-detect autofocus can be used to compose photographs with the subject positioned anywhere in the frame.
- **Hand-held** (): Choose when taking hand-held shots of moving subjects, or when framing photographs at angles that make it difficult to use the viewfinder ( 52). Camera focuses normally using phase-detection autofocus.



## **Phase-Detection Versus Contrast-Detect AF**

The camera normally uses phase-detection autofocus, in which focus is adjusted based on data from a special focusing sensor. When **Tripod** is selected in live view, however, the camera uses contrast-detect autofocus, in which the camera analyses the data from the image sensor and adjusts focus to produce the greatest contrast. Contrast-detect autofocus takes longer than phase-detection autofocus.

# Tripod Mode (📷)

## 1 Frame a picture in the viewfinder.

With the camera mounted on a tripod or resting on a stable, level surface, frame the subject in the viewfinder.

## 2 Choose Tripod for Live view mode.

To display the menus, press the **MENU** button. Highlight **Tripod** in the **Live view mode** menu and press **OK**.

MENU button

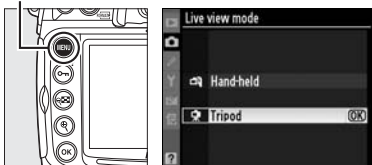

## 3 Press the **Lv** button.

The mirror will be raised and the view through the lens will be displayed in the camera monitor instead of the viewfinder.

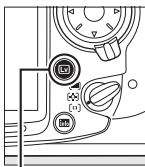

**Lv** button

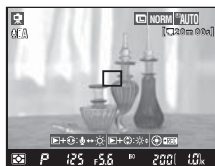

## 4 Focus.

**Autofocus** (focus mode **S** or **C**): In tripod mode, the focus point for contrast-detect autofocus can be moved to any point in the frame using the multi selector.

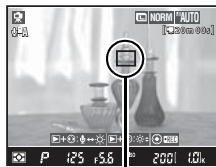

Contrast-detect focus point

To focus using contrast-detect autofocus, press the **AF-ON** button. The focus point will blink green and the monitor may brighten while the camera focuses. If the camera is able to focus using contrast-detect autofocus, the focus point will be displayed in green; if the camera is unable to focus, the focus point will blink red.

**AF-ON** button

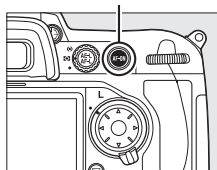

### **Contrast-Detect Autofocus**

The camera will not continue to adjust focus while the **AF-ON** button is pressed in continuous-servo autofocus mode. In both single-servo and continuous-servo autofocus modes, the shutter can be released even when the camera is not in focus.

**Manual focus** (focus mode **M**;  83): Use zoom for precise focus.

To magnify the view in the monitor up to 13× and check focus, press the  **button** button.

While the view through the lens is zoomed in, a navigation window will appear in the bottom right corner of the display.

Use the multi selector to scroll to areas of the frame not visible in the monitor.

Press  to exit zoom.

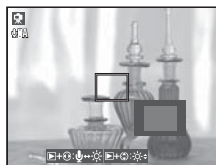
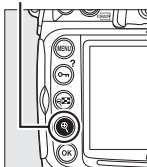



## 5 Take the picture.

Press the shutter-release button the rest of the way down to take the picture. The monitor turns off during shooting.



## 6 End live view.

Press the  button to end live view.



### **Focusing with Contrast-Detect Autofocus**

Contrast-detect autofocus will take longer than normal (phase-detection) autofocus. In the following situations, the camera may be unable to focus using contrast-detect autofocus:

- The camera is not mounted on a tripod
- The subject contains lines parallel to the long edge of the frame
- The subject lacks contrast
- The subject in the focus point contains areas of sharply contrasting brightness, or the subject is lit by spot lighting or by a neon sign or other light source that changes in brightness
- A cross (star) filter or other special filter is used
- The subject appears smaller than the focus point
- The subject is dominated by regular geometric patterns (e.g., windows in a skyscraper)
- The subject is moving

Note that the focus point may sometimes be displayed in green when the camera is unable to focus.

Use an AF-S lens. The desired results may not be achieved with other lenses or teleconverters.

### **Remote Cords**

If the shutter-release button on a remote cord (available separately; see  356) is pressed halfway for over a second in tripod mode, it will activate contrast-detect autofocus. If the remote cord shutter-release button is pressed all the way down without focusing, focus will not be adjusted before the picture is taken.

# Hand-Held Mode (📷)

## 1 Choose Hand-held for Live view mode.

To display the menus, press the MENU button. Highlight **Hand-held** in the **Live view mode** menu and press **OK**.

MENU button

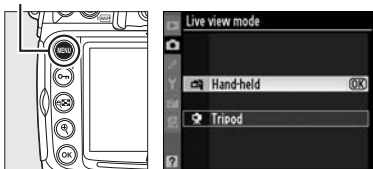

LV

## 2 Press the LV button.

The mirror will be raised and the view through the lens will be displayed in the camera monitor instead of the viewfinder.

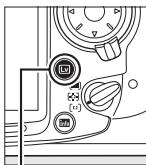

LV button



## 3 Frame a picture in the monitor.

To magnify the view in the monitor up to 3x, press the **📷** button.

📷 button

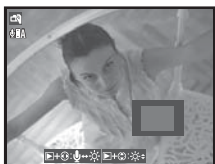
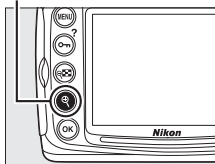

While the view through the lens is zoomed in, a navigation window will appear in the bottom right corner of the display. Use the multi selector to scroll within the AF area brackets.



---

## 4 Focus.

### **Autofocus** (focus mode **S** or **C**):

Press the shutter-release button halfway or press the **AF-ON** button. The camera will focus normally and set exposure. Note that the mirror will click back into place while either button is pressed, temporarily interrupting live view. Live view is restored when the button is released.



**Manual focus** (focus mode **M**;  83): Focus using the lens focusing ring.



---

## 5 Take the picture.

Press the shutter-release button the rest of the way down to reset focus and exposure and take the picture. The monitor turns off during shooting.



---

## 6 End live view.

Press the  button to end live view.

## ✔ No Picture

After shooting, play the picture back in the monitor to ensure that the photograph has been recorded. In hand held mode, note that the sound the mirror makes when the shutter-release button is pressed halfway or the **AF-ON** button is pressed can be mistaken for the sound of the shutter, and that if single-servo AF is used, a photograph will only be recorded if the camera is able to focus.

## ✔ Shooting in Live View Mode

Although they will not appear in the final picture, banding or distortion may be visible in the monitor under fluorescent, mercury vapor, or sodium lamps or if the camera is panned horizontally or if an object moves at high speed through the frame. Bright light sources may leave after-images in the monitor when the camera is panned. Bright spots may also appear. When shooting in live view mode, avoid pointing the camera at the sun or other strong light sources. Failure to observe this precaution could result in damage to the camera's internal circuitry.

Live view shooting ends automatically if the lens is removed.

Live view mode can be used for up to an hour.

Note, however, that when used in live view mode for extended periods, the camera may become noticeably warm and its internal temperature may rise, resulting in image noise and unusual colors. To prevent damage to the camera's internal circuits, live view shooting will end automatically before the camera overheats. A count-down display will appear in the monitor 30 s before shooting ends. At high ambient temperatures, this display may appear immediately when live view mode is selected.



During live view, the camera displays the shutter speed and aperture in effect at the start of live view. Exposure is metered again when the shutter-release button is pressed all the way down.

Metering can not be changed during live view. Choose a metering method before starting live view. To reduce blur in tripod mode, choose **On** for Custom Setting d10 (**Exposure delay mode**,  278).

## ✔ Exposure Compensation

In **P**, **S**, and **A** modes, exposure compensation can be adjusted by  $\pm 5$  EV in increments of  $1/3$  EV ( 118).

## The Information Display

To hide or display indicators in the monitor in live view mode, press the  button.

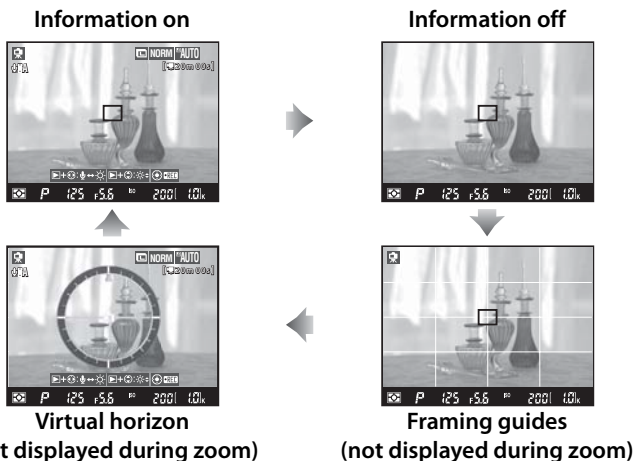





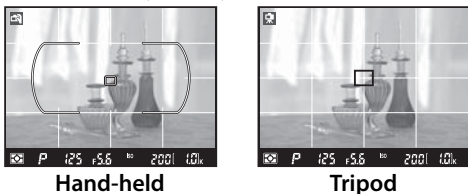

## AF area brackets

AF area brackets are displayed only in hand held mode.



Lv

## **Monitor Brightness**

Monitor brightness can be adjusted by pressing the  and  button. The brightness indicator at the right of the display will turn yellow; keeping the  button pressed, press  or  to adjust brightness (note that monitor brightness has no effect on pictures taken in live view mode). To return to live view, release the  button.

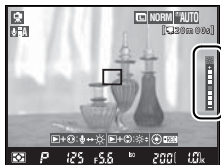

## **HDMI**

When the camera is attached to an HDMI video device, the camera monitor will turn off and the video device will display the view through the lens as shown at right.

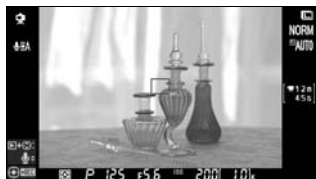



# Recording and Viewing Movies

This chapter describes how to record movies in live view.



<b>Recording Movies</b> .....	<b>58</b>
<b>Viewing Movies</b> .....	<b>63</b>
<b>Editing Movies</b> .....	<b>64</b>

# Recording Movies

Movies can be recorded at 24 fps in live view mode. Before recording, choose a Picture Control (📖 154) and color space (📖 166).

## 1 Choose a live view mode. MENU button

To display the menus, press the MENU button. Highlight an option in the **Live view mode** menu and press **OK**:

- **Tripod:** In modes **A** and **M**, movies are recorded at the aperture selected before live view starts (📖 109, 111; the smallest aperture available with movies is f/16). Focus can be adjusted during shooting using contrast-detect AF.
- **Hand-held:** The camera automatically adjusts shutter speed and aperture in response to changes in subject brightness.

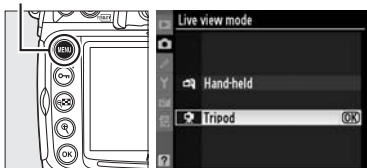

### Using an External Microphone

Instead of the built-in microphone, commercially-available external microphones can be used to avoid picking up sounds produced by the lens during focusing or vibration reduction. Stereo recording is available with any microphone that has a stereo mini-pin jack (3.5 mm diameter). Microphone sensitivity can be adjusted in the **Movie settings > Microphone** menu (📖 62).

## 2 Press the **Lv** button.

The mirror is raised and the view through the lens is displayed in the monitor instead of the viewfinder.

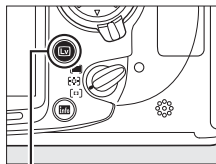

### The Icon

A  icon indicates that movies can not be recorded.



### 3 Focus.

Before shooting, frame the opening shot and either press the **AF-ON** button (**Tripod**) or press the shutter-release button halfway (**Hand-held**) to focus on your subject. In hand-held mode, autofocus is not available after recording begins.

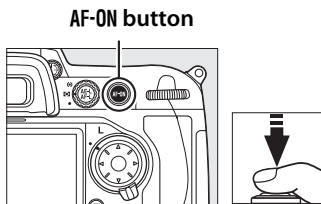

### 4 Start recording.

Press the center of the multi selector to start recording. Both video and monaural sound are recorded; do not cover the microphone during recording (the built-in microphone is located on the front of the camera). A recording indicator and the time available are displayed in the monitor. Exposure can be locked by pressing the **AE-L/AF-L** button (☐116) or altered by up to  $\pm 3$  EV using exposure compensation (☐118).



#### Recording indicator



#### Time remaining

#### Focusing During Recording

In tripod mode, the camera can be focused by pressing the **AF-ON** button (during shooting, a beep will not sound when the camera focuses, but note that other sounds made during contrast-detect autofocus may be picked up by the microphone). Autofocus is not available in hand-held mode after recording begins; use manual focus to focus during recording (☐ 83; note that in hand-held mode, recording will end if the shutter-release button is pressed halfway or the **AF-ON** button is pressed).

## 5 End recording.

Press the center of the multi selector again to end recording (to end recording and take a still picture in live view, press the shutter-release button all the way down). Recording will end automatically when the maximum size is reached or the memory card is full.

### **Maximum Size**





Individual movie files can be up to 2 GB in size. The maximum length is 5 minutes for movies with a frame size of 1280 × 720, 20 minutes for other movies; note that depending on memory card write speed, shooting may end before this length is reached.



### **See Also**

Frame size and microphone sensitivity can be selected in the **Movie settings** menu (📖 62). The behavior of the **AE-L/AF-L** button can be adjusted using Custom Setting f7 (**Assign AE-L/AF-L button**; 📖 296).

### **Adjusting Microphone Sensitivity**

Microphone sensitivity can be adjusted without leaving live view. Before pressing the center of the multi selector to start recording, hold the  button and press . A microphone settings icon will be displayed in the monitor. Keep the  button pressed and press  and  to adjust microphone sensitivity.

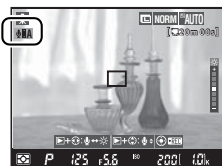

## ✓ Recording Movies

Banding or distortion may be visible in the monitor and in the final movie under fluorescent, mercury vapor, or sodium lamps or if the camera is panned horizontally or an object moves at high speed through frame. Bright light sources may leave after-images when the camera is panned. Jagged edges, false colors, moiré, and bright spots may also appear. When recording movies, avoid pointing the camera at the sun or other strong light sources. Failure to observe this precaution could result in damage to the camera's internal circuitry.

In tripod mode, movies may be over- or under-exposed at some aperture settings. Before shooting, check the brightness of the scene in the monitor; if the picture is too bright or too dark, end live view and adjust aperture as necessary. Note that depending on the brightness of the subject, changes to exposure may have no visible effect.

Recording ends automatically if the lens is removed. Recording may end automatically before the maximum file size is reached when recording to memory cards with slow write speeds.

When used in live view mode for extended periods, the camera's internal temperature may rise, resulting in image noise and unusual colors (the camera may also become noticeably warm, but this does not indicate a malfunction). To prevent damage to the camera's internal circuits, recording will end automatically before the camera overheats. A count-down display will appear in the monitor 30 s before shooting ends. At high ambient temperatures, this display may appear immediately when live view mode is selected.



Matrix metering is used regardless of the metering method selected. The camera adjusts shutter speed and ISO sensitivity automatically.



## ■ Movie Settings

Adjust movie settings before recording.

### 1 Select Movie settings.

Press the **MENU** button to display the menus. Highlight **Movie settings** in the shooting menu and press ►.

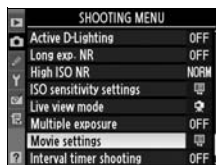
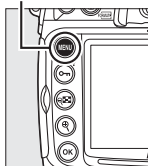

MENU button



### 2 Choose movie options.

To choose a frame size, highlight **Quality** and press ►. Highlight one of the following options and press OK to select:



Option	Frame size (pixels)	Maximum length
 1280/720 <b>1280×720 (16:9)</b>	1280 × 720	5 min.
 640/424 <b>640×424 (3:2)</b>	640 × 424	20 min.
 320/216 <b>320×216 (3:2)</b>	320 × 216	

To turn the built-in or external microphone on or off or to adjust microphone sensitivity, highlight **Microphone** and press ►. To turn sound recording off, highlight **Microphone off** and press OK. Selecting any other option turns recording on and sets the microphone to the selected sensitivity.

To choose a destination when using two memory cards, highlight **Destination** and press ►. To record movies to the CompactFlash card, highlight **CF card slot** and press OK. Select **SD card slot** to record movies to the SD memory card.

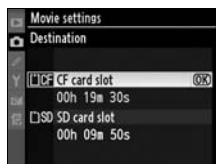



The menu shows the time available on each card; recording ends automatically when no time remains.

# Viewing Movies

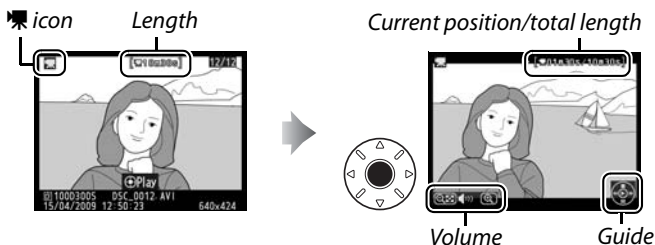
Movies are indicated by a  icon in full-frame playback (□204). Press the center of the multi selector to start playback.



The following operations can be performed:

To	Use	Description
Pause	▼/OK	Pause playback.
Play		Resume playback when movie is paused or during rewind/advance.
Rewind/advance	◀/▶	While playback is in progress, speed doubles with each press, from 2× to 4× to 8× to 16×; keep pressed to skip to beginning or end of movie. While playback is paused, movie rewinds or advances one frame at a time; keep pressed for continuous rewind or advance.
Adjust volume	🔊/🔇	Press 🔊 to increase volume, 🔇 to decrease.
Trim movie	OK	See page 64 for more information.
Resume shooting		Monitor turns off. Photographs can be taken immediately.
Display menus	MENU	See page 243 for more information.
Exit	▲/▶	Exit to full-frame playback.

## icon

 is displayed in full-frame and movie playback if **Microphone off** is selected for **Microphone** in **Movie settings** menu.



# Editing Movies

Trim unwanted footage to create edited copies of movies.

## 1 Display retouch options.

Display a movie in full-frame playback and press **OK** to display retouch options.



## 2 Select Edit movie.

Highlight **Edit movie** and press **▶**.



## 3 Choose an option.

To trim the opening footage from the copy, highlight **Choose start point** and press **OK**. Select **Choose end point** to trim the ending footage.



## 4 View the movie and choose a starting or end point.

Press the center of the multi selector to start or resume playback, **▼** to pause, and **◀** or **▶** to rewind or advance (see page 63; pause to rewind or advance one frame at a time). The **🔊** and **🔇** buttons control volume. With the movie paused on the desired frame, press **▲** to delete all frames before (**Choose start point**) or after (**Choose end point**) the selected frame. Starting and ending frames are shown by **📅** and **📅** icons.



## 5 Save the copy.

Select **Yes** and press **OK** to save the edited copy. If necessary, the copy can be trimmed as described above to remove additional footage. Edited copies are indicated by a **TM** icon in full-frame playback.



### Editing Movies

Movies must be at least two seconds long. The current position will be displayed in red if creating a copy at the current playback position would result in a movie less than two seconds long. The copy will not be saved if there is insufficient space available on the memory card.

To prevent the camera from turning off unexpectedly, use a fully-charged battery when editing movies.

### The Retouch Menu

Movies can also be edited from the retouch menu (📖 315).









# Image Recording Options

This section describes how to choose image quality and size.

<b>Image Quality.....</b>	<b>68</b>
<b>Image Size.....</b>	<b>71</b>
<b>Using Two Memory Cards.....</b>	<b>72</b>



# Image Quality

The D300S supports the following image quality options. See page 394 for information on the number of pictures that can be stored at different image quality and size settings.

Option	File type	Description
NEF (RAW)	NEF	RAW data from the image sensor are saved directly to the memory card in Nikon Electronic Format (NEF). Use with images that will be transferred to a computer for printing or processing.
TIFF (RGB)	TIFF (RGB)	Record uncompressed TIFF-RGB images at a bit depth of 8 bits per channel (24-bit color). TIFF is supported by a wide variety of imaging applications.
JPEG fine	JPEG	Record JPEG images at a compression ratio of roughly 1:4 (fine image quality).*
JPEG normal		Record JPEG images at a compression ratio of roughly 1:8 (normal image quality).*
JPEG basic		Record JPEG images at a compression ratio of roughly 1:16 (basic image quality).*
NEF (RAW)+ JPEG fine	NEF/ JPEG	Two images are recorded, one NEF (RAW) image and one fine-quality JPEG image.
NEF (RAW)+ JPEG normal		Two images are recorded, one NEF (RAW) image and one normal-quality JPEG image.
NEF (RAW)+ JPEG basic		Two images are recorded, one NEF (RAW) image and one basic-quality JPEG image.

\* **Size priority** selected for **JPEG compression**.

## **NEF (RAW) Recording**

The **NEF (RAW) recording** item in the shooting menu controls compression (☐ 70) and bit depth (☐ 70) for NEF (RAW) images.

## **JPEG Compression**

JPEG images can be compressed for relatively uniform file size or optimal image quality. The **JPEG compression** option in the shooting menu can be used to choose the type of compression (☐ 70).

Image quality is set by pressing the **QUAL** button and rotating the main command dial until the desired setting is displayed in the control panel.

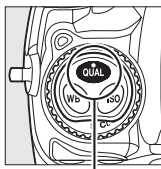

QUAL button

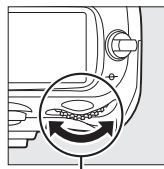

Main command dial

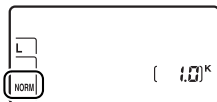

Control panel

### **NEF (RAW)**

Once transferred to a computer, NEF (RAW) images can only be viewed using ViewNX (available on the supplied Software Suite CD) or Capture NX 2 (available separately; □ 355). JPEG copies of NEF (RAW) images can be created using the **NEF (RAW) processing** option in the retouch menu (□ 327). Note that the option selected for image size does not affect the size of NEF (RAW) images.

### **NEF (RAW)+JPEG**

When photographs taken at settings of NEF (RAW) + JPEG are viewed on the camera with only one memory card inserted, only the JPEG image will be displayed. If both copies are recorded to the same memory card, both copies will be erased when the photo is deleted. If the JPEG copy is recorded to a separate memory card using the **Secondary slot function > RAW primary, JPEG secondary** option, deleting the JPEG copy will not delete the NEF (RAW) image.

### **The Image Quality Menu**

Image quality can also be adjusted using the **Image quality** option in the shooting menu (□ 253).

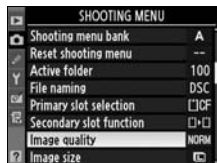

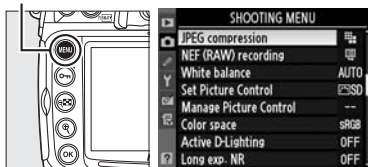

The following options can be accessed from the shooting menu. Press the **MENU** button to display the menus, highlight the desired option and press **▶**.

#### MENU button





## ■■ JPEG Compression

Choose the type of compression for JPEG images.

Option	Description
 <b>Size priority</b>	Images are compressed to produce relatively uniform file size.
 <b>Optimal quality</b>	Optimal image quality. File size varies with scene recorded.

## ■■ NEF (RAW) Recording > Type

Choose the type of compression for NEF (RAW) images.

Option	Description
 <b>Lossless compressed</b>	NEF images are compressed using a reversible algorithm, reducing file size by about 20–40% with no effect on image quality.
 <b>Compressed</b>	NEF images are compressed using a non-reversible algorithm, reducing file size by about 40–55% with almost no effect on image quality.
<b>Uncompressed</b>	NEF images are not compressed.

## ■■ NEF (RAW) Recording > NEF (RAW) Bit Depth

Choose a bit depth for NEF (RAW) images.

Option	Description
12-bit <b>12-bit</b>	NEF (RAW) images are recorded at a bit-depth of 12 bits.
14-bit <b>14-bit</b>	NEF (RAW) images are recorded at a bit-depth of 14 bits, producing files roughly 1.3 times larger than 12-bit files but increasing the color data recorded. Maximum frame advance rate (☐ 89) falls to 2.5 fps.

# Image Size

Image size is measured in pixels. Choose from the following options:

Option	Size (pixels)	Size when printed at 300 dpi (approx.)*
<b>L</b>	4,288 × 2,848	36.3 × 24.1 cm (14.3 × 9.5 in.)
<b>M</b>	3,216 × 2,136	27.2 × 18.1 cm (10.7 × 7.1 in.)
<b>S</b>	2,144 × 1,424	18.2 × 12.1 cm (7.1 × 4.7 in.)

\* Print size in inches equals image size in pixels divided by printer resolution in dots per inch (dpi; 1 inch = approximately 2.54 cm).

Image size can be set by pressing the **QUAL** button and rotating the sub-command dial until the desired option is displayed in the control panel.

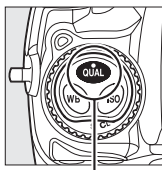

QUAL button

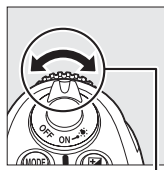

Sub-command dial

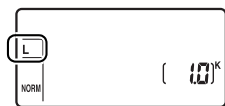

Control panel

## The Image Size Menu

Image size can also be adjusted using the **Image size** option in the shooting menu ( 253).

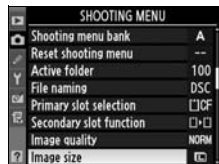

# Using Two Memory Cards

When two memory cards are inserted in the camera, you can choose one as the primary card using the **Primary slot selection** item in the shooting menu. Select **CF card slot** to designate the card in the CompactFlash card slot as the primary card, **SD card slot** to choose the SD memory card. The roles played by the primary and secondary cards can be chosen using the **Secondary slot function** option in the shooting menu. Choose from **Overflow** (the secondary card is used only when the primary card is full), **Backup** (each picture is recorded to both the primary and secondary card), and **RAW primary, JPEG secondary** (as for **Backup**, except that the NEF/RAW copies of photos recorded at settings of NEF/RAW + JPEG are recorded only to the primary card and the JPEG copies only to the secondary card).



## “Backup” and “RAW Primary, JPEG Secondary”

The camera shows the number of exposures remaining on the card with the least amount of memory. Shutter release will be disabled when either card is full.



# Focus

## *– Controlling How the Camera Focuses*

This section describes the options that control how your camera focuses.

<b>Focus Mode .....</b>	<b>74</b>
<b>AF-Area Mode .....</b>	<b>76</b>
<b>Focus Point Selection .....</b>	<b>78</b>
<b>Focus Lock .....</b>	<b>80</b>
<b>Manual Focus .....</b>	<b>83</b>



# Focus Mode

Focus mode is controlled by the focus-mode selector on the front of the camera. There are two *autofocus* (AF) modes, in which the camera focuses automatically when the shutter-release button is pressed halfway, and one *manual focus* mode, in which focus must be adjusted manually using the focusing ring on the lens:

Focus-mode selector

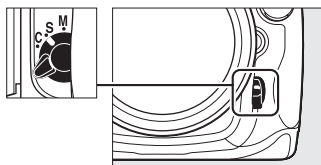

Option	Description
 <b>S</b> Single-servo AF	Camera focuses when shutter-release button is pressed halfway. Focus locks when in-focus indicator (●) appears in viewfinder, and remains locked while shutter-release button is pressed halfway ( <i>focus lock</i> ). At default settings, shutter can only be released when in-focus indicator is displayed ( <i>focus priority</i> ).
<b>C</b> Continuous- servo AF	Camera focuses continuously while shutter-release button is pressed halfway. If subject moves, camera will engage <i>predictive focus tracking</i> (☐ 75) to predict final distance to subject and adjust focus as necessary. At default settings, shutter can be released whether or not subject is in focus ( <i>release priority</i> ).
<b>M</b> Manual (☐ 83)	Camera does not focus automatically; focus must be adjusted manually using the lens focusing ring. If maximum aperture of lens is f/5.6 or faster, viewfinder focus indicator can be used to confirm focus ( <i>electronic range finding</i> ; ☐ 84), but photographs can be taken at any time, whether or not subject is in focus.

Choose single-servo AF for landscapes and other stationary subjects. Continuous-servo AF may be a better choice with erratically-moving subjects. Manual focus is recommended when the camera is unable to focus using autofocus.



### **The AF-ON Button**

For the purpose of focusing the camera, pressing the **AF-ON** button has the same effect as pressing the shutter-release button halfway; note, however, that vibration reduction (available with VR lenses) can only be engaged by pressing the shutter-release button halfway.

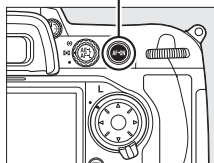

**AF-ON button**



### **Predictive Focus Tracking**

In continuous-servo AF, the camera will initiate predictive focus tracking if the subject moves toward or away from the camera while the shutter-release button is pressed halfway or the **AF-ON** button is pressed. This allows the camera to track focus while attempting to predict where the subject will be when the shutter is released.

### **See Also**

For information on using focus priority in continuous-servo AF, see Custom Setting a1 (**AF-C priority selection**,  263). For information on using release priority in single-servo AF, see Custom Setting a2 (**AF-S priority selection**,  264). For information on preventing the camera from focusing when the shutter-release button is pressed halfway, see Custom Setting a5 (**AF activation**,  266).



# AF-Area Mode

AF-area mode determines how the focus point is selected in autofocus mode (□ 74). To select the AF-area mode, rotate the AF-area mode selector. The following options are available:

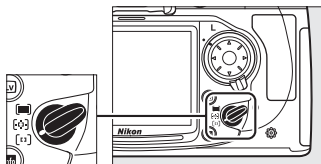

AF-area mode selector

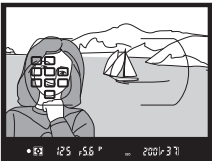





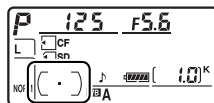



Mode	Description
[□] Single-point AF	User selects focus point manually; camera focuses on subject in selected focus point only. Use for relatively static compositions with subjects that will stay in selected focus point.
[□] Dynamic-area AF	<ul style="list-style-type: none"> <li>• <b>In continuous-servo AF</b> (□ 74), user selects focus point manually; if subject briefly leaves selected focus point, camera will focus based on information from surrounding points. Number of focus points used can be selected from 9, 21, and 51 using Custom Setting a3 (<b>Dynamic AF area</b>, □ 264). If <b>51 points (3D-tracking)</b> is selected for Custom Setting a3, focus point will be selected automatically using 3D-tracking.</li> <li>• <b>In single-servo AF</b>, user selects focus point manually; camera focuses on subject in selected focus point only.</li> </ul>
[□] Auto-area AF	<p>Camera automatically detects subject and selects focus point. If type G or D lens is used, camera can distinguish human subjects from background for improved subject detection. In single-servo AF, active focus points are highlighted for about one second after camera focuses. Active focus points are not displayed in continuous-servo AF.</p> 

## AF-Area Mode

AF-area mode is shown in the control panel.



AF-area mode  
indicator



AF-area mode		Control panel
	Single-point AF	
	Custom Setting a3 ( <b>Dynamic AF area</b> ,  264)	
	9 points	
	21 points	
	51 points	
	51 points (3D-tracking)	
	Auto-area AF	

\* Only active focus point is displayed in the viewfinder. Remaining focus points provide information to assist focus operation.

## Manual Focus

Single-point AF is automatically selected when manual focus is used.

## See Also

For information on the settings available in dynamic-area AF, see Custom Setting a3 (**Dynamic AF area**,  264). For information on adjusting how long the camera waits before refocusing when an object moves in front of the camera, see Custom Setting a4 (**Focus tracking with lock-on**,  266).

# Focus Point Selection

The D300S offers a choice of 51 focus points that together cover a wide area of the frame. The focus point can be selected manually, allowing photographs to be composed with the main subject positioned almost anywhere in the frame (single-point and dynamic-area AF), or automatically (auto-area AF; note that manual focus point detection is not available when auto-area AF is selected). To select the focus point manually:

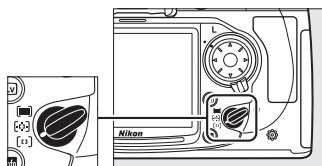

AF-area mode selector

## 1 Rotate the focus selector lock to ●.

This allows the multi selector to be used to select the focus point.

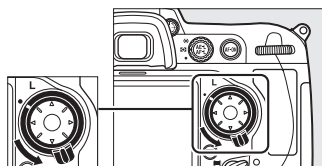

Focus selector lock

## 2 Select the focus point.





Use the multi selector to select the focus point. The center focus point can be selected by pressing the center of the multi selector.



The focus selector lock can be rotated to the locked (L) position following selection to prevent the selected focus point from changing when the multi selector is pressed.



### See Also

For information on choosing when the focus point is illuminated, see Custom Setting a6 (**AF point illumination**,  266). For information on setting focus-point selection to “wrap around,” see Custom Setting a7 (**Focus point wrap-around**,  267). For information on choosing the number of focus points that can be selected using the multi selector, see Custom Setting a8 (**AF point selection**,  267). For information on changing the role of the multi selector center button, see Custom Setting f2 (**Multi selector center button**,  291).



# Focus Lock

Focus lock can be used to change the composition after focusing, making it possible to focus on a subject that will not be in a focus point in the final composition. It can also be used when the autofocus system is unable to focus (📖 82).

## 1 Focus.

Position the subject in the selected focus point and press the shutter-release button halfway to initiate focus.



## 2 Check that the in-focus indicator (●) appears in the viewfinder.



### *Single-servo AF*

Focus will lock automatically when the in-focus indicator appears, and remain locked until you remove your finger from the shutter-release button.



Focus can also be locked by pressing the **AE-L/AF-L** button (see following page).

### **Shutter-Release Button AE-L**

If **On** is selected for Custom Setting c1 (**Shutter-release button AE-L**; 📖 273), exposure will lock when the shutter-release button is pressed halfway.

### **Continuous-servo AF**

Press the **AE-L/AF-L** button to lock both focus and exposure (an **AE-L** icon appears in the viewfinder, see page 116). Focus and exposure will remain locked while the **AE-L/AF-L** button is pressed, even if you later remove your finger from the shutter-release button.

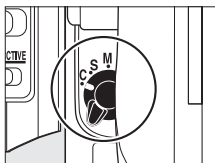

**Shutter-release button**

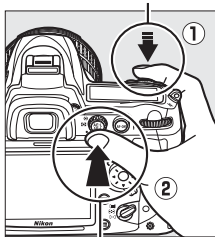

**AE-L/AF-L button**

## **3** **Recompose the photograph and shoot.**

Focus will remain locked between shots as long as the shutter-release button is kept pressed halfway, allowing several photographs in succession to be taken at the same focus setting. Focus will also remain locked between shots while the **AE-L/AF-L** button is pressed.



Do not change the distance between the camera and the subject while focus lock is in effect. If the subject moves, focus again at the new distance.

### **See Also**

For information on choosing the role played by the **AE-L/AF-L** button, see Custom Setting f7 (**Assign AE-L/AF-L button**,  296).

# Getting Good Results with Autofocus

Autofocus does not perform well under the conditions listed below. The shutter release may be disabled if the camera is unable to focus under these conditions, or the in-focus indicator (●) may be displayed and the camera may sound a beep, allowing the shutter to be released even when the subject is not in focus. In these cases, use manual focus (📖 83) or use focus lock (📖 80) to focus on another subject at the same distance and then recompose the photograph.

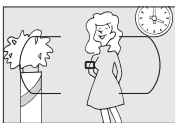

*There is little or no contrast between the subject and the background*

**Example:** subject is the same color as the background.



*The focus point contains objects at different distances from the camera*

**Example:** subject is inside a cage.



*The subject is dominated by regular geometric patterns*

**Example:** a row of windows in a skyscraper.

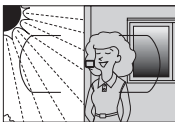

*The focus point contains areas of sharply contrasting brightness*

**Example:** subject is half in the shade.



*Background objects appear larger than the subject*

**Example:** a building is in the frame behind the subject.

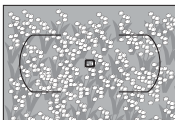

*The subject contains many fine details*

**Example:** a field of flowers or other subjects that are small or lack variation in brightness.



# Manual Focus

Manual focus is available for lenses that do not support autofocus (non-AF NIKKOR lenses) or when the autofocus does not produce the desired results (☐ 82).

- **AF-S lenses:** Set the lens focus mode switch to **M**.
- **AF lenses:** Set the lens focus mode switch (if present) and camera focus-mode selector to **M**.

## ☑ AF Lenses

Do not select focus mode **S** or **C**.  
Failure to observe this precaution could damage the camera.

Focus-mode selector

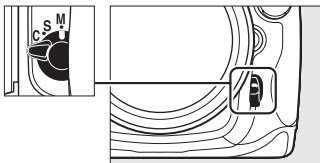

- **Manual focus lenses:** Set the camera focus-mode selector to **M**.

To focus manually, adjust the lens focusing ring until the image displayed on the clear matte field in the viewfinder is in focus. Photographs can be taken at any time, even when the image is not in focus.

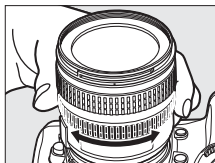

## The Electronic Rangefinder

If the lens has a maximum aperture of  $f/5.6$  or faster, the viewfinder focus indicator can be used to confirm whether the subject in the selected focus point is in focus (the focus point can be selected from any of the 51 focus points). After positioning the subject in the selected focus point, press the shutter-release button halfway and rotate the lens focusing ring until the in-focus indicator (●) is displayed. Note that with the subjects listed on page 82, the in-focus indicator may sometimes be displayed when the subject is not in focus; confirm focus in the viewfinder before shooting.

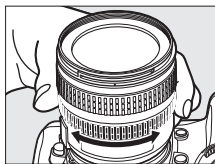

### Focal Plane Position

To determine the distance between your subject and the camera, measure from the focal plane mark (⊖) on the camera body. The distance between the lens mounting flange and the focal plane is 46.5 mm (1.83 in.).

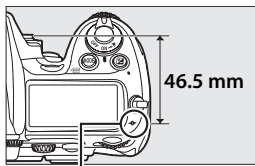

Focal plane mark



# Release Mode

– *Single Frame, Continuous, Quiet Shutter-Release, Self-Timer, or Mirror Up*





Release mode determines how the camera takes photographs: one at a time (with or without reduced camera noise), in a continuous sequence, with a timed shutter-release delay, or with the mirror raised to enhance shutter response and minimize vibration.

<b>Choosing a Release Mode.....</b>	<b>86</b>
<b>Continuous Mode.....</b>	<b>88</b>
<b>Self-Timer Mode .....</b>	<b>91</b>
<b>Mirror up Mode.....</b>	<b>93</b>



# Choosing a Release Mode

The camera supports the following release modes:

Mode	Description
<b>S</b> Single frame	Camera takes one photograph each time shutter-release button is pressed.
<b>CL</b> Continuous low speed	While shutter-release button is held down, camera records 1–7 frames per second. <sup>1</sup> Frame rate can be chosen using Custom Setting d5 ( <b>CL mode shooting speed</b> ,  276).
<b>CH</b> Continuous high speed	While shutter-release button is held down, camera records up to 7 frames per second. <sup>2</sup>
<b>Q</b> Quiet shutter-release	As for single-frame except that beep does not sound when camera focuses regardless of setting selected for Custom Setting d1 ( <b>Beep</b> ;  275) and noise made by camera after shooting (from moment following shutter release to point finger is removed from shutter-release button, when mirror is lowered) is kept to minimum, making this mode less noisy than single-frame.
 Self-timer	Use self-timer for self-portraits or to reduce blurring caused by camera shake (  91).
<b>Mup</b> Mirror up	Choose this mode to minimize camera shake in telephoto or close-up photography or in other situations in which the slightest camera movement can result in blurred photographs (  93).

- 1 Average frame rate with an EN-EL3e battery, continuous-servo AF, manual or shutter-priority auto exposure, a shutter speed of  $1/250$  s or faster, remaining settings other than Custom Setting d5 at default values, and memory remaining in memory buffer.
- 2 Average frame rate with an EN-EL3e battery, continuous-servo AF, manual or shutter-priority auto exposure, a shutter speed of  $1/250$  s or faster, other settings at default values, and memory remaining in memory buffer.

To choose a release mode, press the release mode dial lock release and turn the release mode dial to the desired setting.

### Release mode dial lock release

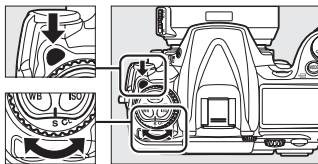

### Release mode dial



# Continuous Mode

To take pictures in **CH** (continuous high speed) and **CL** (continuous low speed) modes:

## 1 Select CH or CL mode.

Press the release mode dial lock release and turn the release mode dial to **CH** or **CL**.

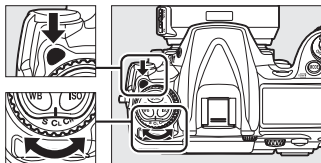

Release mode dial

## 2 Frame a photograph, focus, and shoot.



While the shutter-release button is pressed all the way down, pictures will be taken at about 7 fps in continuous high speed mode, or at the frame rate selected for Custom Setting d5 (**CL mode shooting speed**,  276) in continuous low speed mode.

## Power Source and Frame Rate

The frame advance rate varies with the power source used.

Power source	Frame advance rate (approx.) <sup>1</sup>
Battery (EN-EL3e)	7 fps
AC adapter	7.6 fps <sup>2</sup>
MB-D10 battery pack with EN-EL3e battery	7 fps
MB-D10 battery pack with EN-EL4a battery	8 fps <sup>2</sup>
MB-D10 battery pack with AA-size batteries <sup>3</sup>	7.7 fps <sup>2</sup>

- 1 Average frame rate with continuous-servo AF, manual or shutter-priority auto exposure, a shutter speed of  $1/250$  s or faster, other settings at default values, and memory remaining in memory buffer. Frame advance rate when recording NEF (RAW) or NEF (RAW) + JPEG pictures with **14-bit** selected for **NEF (RAW) recording > NEF (RAW) bit depth** (□ 70) is approximately 2.5 fps. Frame rate drops when vibration reduction (available with VR lenses) is on.
- 2 If **On** is selected for **ISO sensitivity settings > ISO sensitivity auto control** in the shooting menu (□ 98), frame advance rate in continuous high-speed mode is approximately 7.5 fps.
- 3 Frame rate slows at low temperatures and when batteries are low.

## Buffer Size

The approximate number of images that can be stored in the memory buffer at current settings is shown in the exposure-count displays in the viewfinder and control panel while the shutter-release button is pressed. The illustration at right shows the display when space remains in the buffer for about 37 pictures.

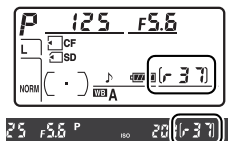

### **The Memory Buffer**

The camera is equipped with a memory buffer for temporary storage, allowing shooting to continue while photographs are being saved to the memory card. Up to 100 photographs can be taken in succession; note, however, that frame rate will drop when the buffer is full.

While photographs are being recorded to the memory card, the access lamp next to the memory card slot will light. Depending on shooting conditions and memory card performance, recording may take from a few seconds to a few minutes. *Do not remove the memory card or remove or disconnect the power source until the access lamp has gone out.* If the camera is switched off while data remain in the buffer, the power will not turn off until all images in the buffer have been recorded. If the battery is exhausted while images remain in the buffer, the shutter release will be disabled and the images transferred to the memory card.

### **See Also**

For information on choosing the maximum number of photographs that can be taken in a single burst, see Custom Setting d6 (**Max. continuous release**,  276). For information on the number of pictures that can be taken in a single burst, see page 394.





# Self-Timer Mode

The self-timer can be used to reduce camera shake or for self-portraits. To use the self-timer, mount the camera on a tripod (recommended) or place the camera on a stable, level surface and follow the steps below:

## 1 Select self-timer mode.

Press the release mode dial lock release and turn the release mode dial to .

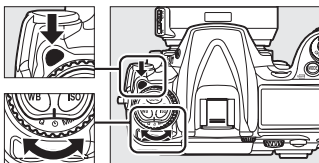

Release mode dial

## 2 Frame the photograph and focus.

In single-servo autofocus (  74), photographs can only be taken if the in-focus (●) indicator appears in the viewfinder.

Focus-mode selector

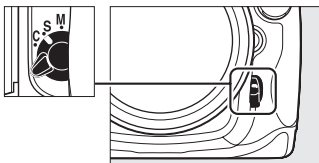

### Cover the Viewfinder

When taking photos without your eye to the viewfinder, remove the DK-23 rubber eyecup (  ); you will need to hold the camera firmly) and cover the viewfinder with the

supplied DK-5 eyepiece cap (  ) to prevent light entering via the viewfinder from interfering with exposure.

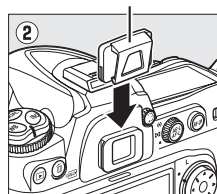
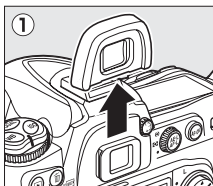

DK-5 eyepiece cap

### 3 Start the timer.

Press the shutter-release button all the way down to start the timer. The self-timer lamp (AF-assist illuminator) will start to blink and a beep will begin to sound. Two seconds before the photograph is taken, the self-timer lamp will stop blinking and the beeping will become more rapid. The shutter will be released about ten seconds after the timer starts.

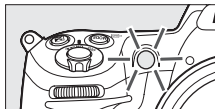

Raising the built-in flash interrupts the timer. To restart, wait until the flash-ready indicator is displayed in the viewfinder and press the shutter-release button halfway.

To turn the self-timer off before a photograph is taken, turn the release mode dial to another setting.



#### **b u l b**

In self-timer mode, a shutter speed of **b u l b** is equivalent to approximately  $\frac{1}{10}$  s.

#### **See Also**

For information on changing the timer duration, see Custom Setting c3 (**Self-timer**, □ 273). For information on setting a beep to sound during the timer count-down, see Custom Setting d1 (**Beep**, □ 275).

# Mirror up Mode

Choose this mode to minimize blurring caused by camera movement when the mirror is raised. Use of a tripod is recommended.

## 1 Select mirror up mode.

Press the release mode dial lock release and turn the release mode dial to **MUP**.

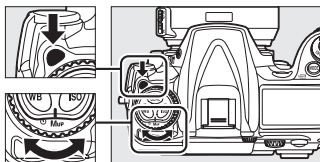

Release mode dial

## 2 Raise the mirror.

Frame the picture, focus, and then press the shutter-release button the rest of the way down to raise the mirror.



### Using the Viewfinder

Note that autofocus, metering, and framing can not be confirmed in the viewfinder while mirror is raised.

## 3 Take a picture.

Press the shutter-release button all the way down again to take a picture. To prevent blurring caused by camera movement, press the shutter-release button smoothly, or use an optional remote cord (📄 356). The mirror lowers when shooting ends.



### Mirror up Mode

A picture will be taken automatically if no operations are performed for about 30 s after the mirror is raised.







# ISO Sensitivity

– *Reacting Faster to Light*

“ISO sensitivity” is the digital equivalent of film speed. The higher the ISO sensitivity, the less light needed to make an exposure, allowing higher shutter speeds or smaller apertures. This chapter describes how to set ISO sensitivity manually and automatically.

<b>Choosing ISO Sensitivity Manually .....</b>	<b>96</b>
<b>Auto ISO Sensitivity Control.....</b>	<b>98</b>

# Choosing ISO Sensitivity Manually

ISO sensitivity can be set to values between ISO 200 and ISO 3200 in steps equivalent to  $\frac{1}{3}$  EV. Settings of from about 0.3 to 1 EV below ISO 200 and 0.3 to 1 EV above ISO 3200 are also available for special situations.

ISO sensitivity can be adjusted by pressing the **ISO** button and rotating the main command dial until the desired setting is displayed in the control panel or viewfinder.

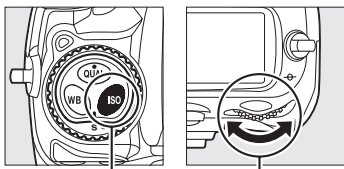

ISO button

Main command dial

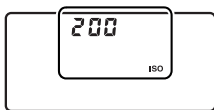

Control panel



Viewfinder



ISO sensitivity: 3200

## The ISO Sensitivity Menu

ISO sensitivity can also be adjusted using the **ISO sensitivity** option in the shooting menu (☞ 253).

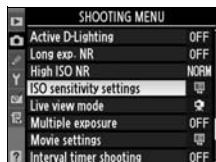

## ISO Sensitivity Settings

The settings available depend on the option selected for Custom Setting b1 (**ISO sensitivity step value**, ☞ 270).

Custom Setting b1 (ISO sensitivity step value)	ISO sensitivity settings available
1/3 step	Lo 1, Lo 0.7, Lo 0.3, 200, 250, 320, 400, 500, 640, 800, 1000, 1250, 1600, 2000, 2500, 3200, Hi 0.3, Hi 0.7, Hi 1
1/2 step	Lo 1, Lo 0.5, 200, 280, 400, 560, 800, 1100, 1600, 2200, 3200, Hi 0.5, Hi 1
1 step	Lo 1, 200, 400, 800, 1600, 3200, Hi 1

\* If possible, the current ISO sensitivity setting is maintained when the step value is changed. If the current ISO sensitivity setting is not available at the new step value, ISO sensitivity will be rounded to the nearest available setting.

## Hi 0.3–Hi 1

The settings **Hi 0.3** through **Hi 1** correspond to ISO sensitivities 0.3–1 EV over ISO 3200 (ISO 4000–6400 equivalent). Pictures taken at these settings are more likely to be subject to noise and color distortion.

## Lo 0.3–Lo 1

The settings **Lo 0.3** through **Lo 1** correspond to ISO sensitivities 0.3–1 EV below ISO 200 (ISO 160–100 equivalent). Use for larger apertures when lighting is bright. Contrast is slightly higher than normal; in most cases, ISO sensitivities of ISO 200 or above are recommended.

## See Also

For information on Custom Setting b1 (**ISO sensitivity step value**), see page 270. For information on using the **High ISO NR** option in the shooting menu to reduce noise at high ISO sensitivities, see page 259.

# Auto ISO Sensitivity Control

If **On** is selected for **ISO sensitivity settings > ISO sensitivity auto control** in the shooting menu, ISO sensitivity will automatically be adjusted if optimal exposure can not be achieved at the value selected by the user (ISO sensitivity is adjusted appropriately when the flash is used).

## 1 Select ISO sensitivity auto control.

To display the menus, press the **MENU** button. Select **ISO sensitivity settings** in the shooting menu, highlight **ISO sensitivity auto control**, and press ►.

MENU button

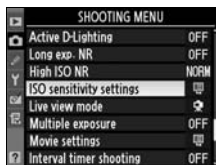
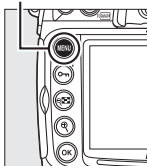

## 2 Select On.

Highlight **On** and press **OK** (if **Off** is selected, ISO sensitivity will remain fixed at the value selected by the user).

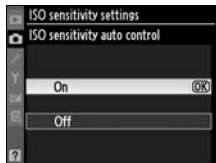

## 3 Adjust settings.

The maximum value for auto ISO sensitivity can be selected using **Maximum sensitivity** (the minimum value for auto ISO sensitivity is automatically set to ISO 200; note that if the value selected for **Maximum sensitivity** is lower than the value currently selected for **ISO sensitivity**, the value selected for **Maximum sensitivity** will be used). In exposure modes **P** and **A**, sensitivity will only be

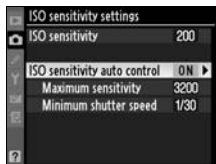



adjusted if underexposure would result at the shutter speed selected for **Minimum shutter speed** ( $1/4000-1$  s). Slower shutter speeds may be used if optimum exposure can not be achieved at the ISO sensitivity value selected for **Maximum sensitivity**. Press **OK** to exit when settings are complete.

When **On** is selected, the control panel and viewfinder show **ISO-AUTO**. When sensitivity is altered from the value selected by the user, these indicators blink and the altered value is shown in the viewfinder.

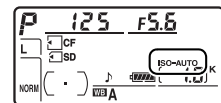

### **Auto ISO Sensitivity Control**

Noise is more likely at higher sensitivities. Use the **High ISO NR** option in the shooting menu to reduce noise (see page 259). When a flash is used, the value selected for **Minimum shutter speed** is ignored in favor of the option selected for Custom Setting e1 (**Flash sync speed**,  281). Note that ISO sensitivity may be raised automatically when auto ISO sensitivity control is used in combination with slow sync flash modes (available with the built-in flash and SB-900, SB-800, SB-600, and SB-400 flash units), possibly preventing the camera from selecting slow shutter speeds.





# Exposure

## – *Controlling How the Camera Sets Exposure*





This section describes the options available to control exposure, including metering, exposure mode, exposure lock, exposure compensation, and bracketing.

<b>Metering .....</b>	<b>102</b>
<b>Exposure Mode .....</b>	<b>104</b>
<i>P</i> : Programmed Auto .....	106
<i>S</i> : Shutter-Priority Auto .....	108
<i>A</i> : Aperture-Priority Auto .....	109
<i>M</i> : Manual .....	111
<b>Long Time-Exposures .....</b>	<b>114</b>
<b>Autoexposure (AE) Lock .....</b>	<b>116</b>
<b>Exposure Compensation .....</b>	<b>118</b>
<b>Bracketing .....</b>	<b>120</b>



# Metering

Metering determines how the camera sets exposure. The following options are available:

Method	Description
 3D color matrix II	Recommended in most situations. Camera meters a wide area of the frame and sets exposure according to distribution of brightness, color, distance, and composition for natural results.
 Center-weighted	Camera meters entire frame but assigns greatest weight to 8-mm circle in center of viewfinder (if CPU lens is attached, area can be selected using Custom Setting b5, <b>Center-weighted area</b> ,  272). Classic meter for portraits. <sup>1</sup>
 Spot	Camera meters circle 3 mm (0.12 in.) in diameter (approximately 2% of frame). Circle is centered on current focus point, making it possible to meter off-center subjects (if non-CPU lens is used or if Auto-area AF is in effect (  76), camera will meter center focus point). Ensures that subject will be correctly exposed, even when background is much brighter or darker. <sup>1</sup>

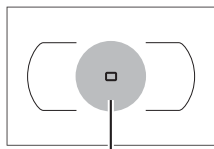

Center-weighted area<sup>2</sup>

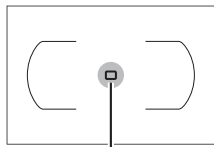

Spot metering area<sup>2</sup>

1 For improved precision with non-CPU lenses, specify lens focal length and maximum aperture in **Non-CPU lens data** menu ( 196).

2 Metered area is not actually displayed in viewfinder.

To choose a metering method, rotate the metering selector until the desired mode is displayed.

### Metering selector

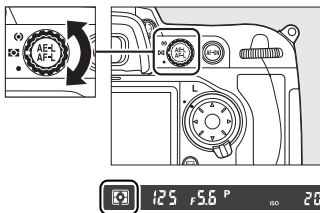



#### **Matrix Metering**

The metering method used is determined by the type of lens attached:

- **Type G and D lenses:** Range information is included when determining exposure (3D color matrix metering II).
- **Other CPU lenses:** Range information is not included when determining exposure (color matrix metering II).
- **Non-CPU lenses:** Color matrix metering is available if focal length and maximum aperture are specified using **Non-CPU lens data** item in setup menu (see page 196; center-weighted metering is used if focal length or aperture is not specified).

#### **See Also**

For information on choosing the size of the area assigned the greatest weight in center-weighted metering, see Custom Setting b5 (**Center-weighted area**,  272). For information on making separate adjustments to optimal exposure for each metering method, see Custom Setting b6 (**Fine tune optimal exposure**,  272).

# Exposure Mode

Exposure mode determines how the camera sets shutter speed and aperture when adjusting exposure. Four modes are available: programmed auto (**P**), shutter-priority auto (**S**), aperture-priority auto (**A**), and manual (**M**).

Mode	Description
<b>P</b> Programmed auto (☞ 106)	Camera sets shutter speed and aperture for optimal exposure. Recommended for snapshots and in other situations in which there is little time to adjust camera settings.
<b>S</b> Shutter-priority auto (☞ 108)	User chooses shutter speed; camera selects aperture for best results. Use to freeze or blur motion.
<b>A</b> Aperture-priority auto (☞ 109)	User chooses aperture; camera selects shutter speed for best results. Use to blur background for portraits or bring both foreground and background into focus for landscape shots.
<b>M</b> Manual (☞ 111)	User controls both shutter speed and aperture. Set shutter speed to “ <b>b u l b</b> ” for long time-exposures.



## Lens Types

When using a CPU lens equipped with an aperture ring (☞ 340), lock the aperture ring at the minimum aperture (highest f-number). Type G lenses are not equipped with an aperture ring.

Non-CPU lenses can only be used in exposure mode **A** (aperture-priority auto) and **M** (manual). In other modes, exposure mode **A** is automatically selected when a non-CPU lens is attached (☞ 342). The exposure mode indicator (**P** or **S**) in the control panel will blink and **A** will be displayed in the viewfinder.

To choose the exposure mode, press the **MODE** button and rotate the main command dial until the desired mode is displayed in the control panel or viewfinder.

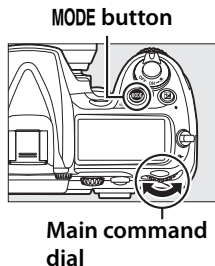

### **Depth-of-Field Preview**

To preview the effects of aperture, press and hold the depth-of-field preview button. The lens will be stopped down to the aperture value selected by the camera (modes **P** and **S**) or the value chosen by the user (modes **A** and **M**), allowing depth of field to be previewed in the viewfinder.

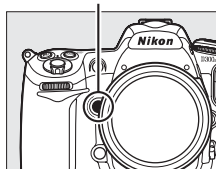

### **Preview button**



### **Custom Setting e4—Modeling Flash**

This setting controls whether the built-in flash and optional flash units that support the Creative Lighting System (CLS; see page 348) will emit a modeling flash when the depth-of-field preview button is pressed. See page 289 for more information.

### **See Also**

See page 98 for information on auto ISO sensitivity control. For information on using the **Long exp. NR** option in the shooting menu for reducing noise at slow shutter speeds, see page 258. For information on choosing the size of the increments available for shutter speed and aperture, see Custom Setting b2 (**EV steps for exposure cntrl.**,  270). For information on changing the roles of the main and sub-command dials, see Custom Setting f8 (**Customize command dials** > **Change main/sub**,  297).

## **P: Programmed Auto**

In this mode, the camera automatically adjusts shutter speed and aperture according to a built-in program to ensure optimal exposure in most situations. This mode is recommended for snapshots and other situations in which you want to leave the camera in charge of shutter speed and aperture. To take photographs in programmed auto:

### **1** Select exposure mode **P**.

Press the **MODE** button and rotate the main command dial until **P** is displayed in the viewfinder and control panel.

**MODE** button

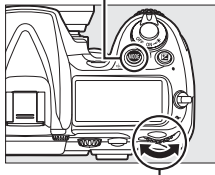

**Main command dial**

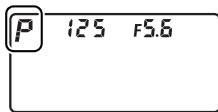

### **2** Frame a photograph, focus, and shoot.



Shutter speed:  $\frac{1}{320}$  s; aperture: f/9



## Flexible Program

In exposure mode *P*, different combinations of shutter speed and aperture can be selected by rotating the main command dial while the exposure meters are on (“flexible program”). Rotate the command dial to the right for large apertures (small f-numbers) that blur background details or fast shutter speeds that “freeze” motion. Rotate the command dial to the left for small apertures (large f-numbers) that increase depth of field or slow shutter speeds that blur motion. All combinations produce the same exposure. While flexible program is in effect, an asterisk (“\*”) appears in the control panel. To restore default shutter speed and aperture settings, rotate the command dial until the asterisk is no longer displayed, choose another mode, or turn the camera off.

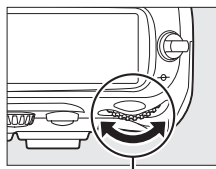

Main command dial

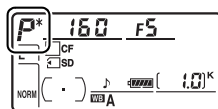

Shutter speed:  $1/2,500$  s;  
aperture: f/2.8



Shutter speed:  $1/60$  s;  
aperture: f/22

## See Also

See page 372 for information on the built-in exposure program.



## 5: Shutter-Priority Auto

In shutter-priority auto, you choose the shutter speed while the camera automatically selects the aperture that will produce the optimal exposure. To take photographs in shutter-priority auto:

### 1 Select exposure mode 5.

Press the **MODE** button and rotate the main command dial until **5** is displayed in the viewfinder and control panel.

MODE button

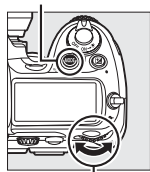

Main command dial

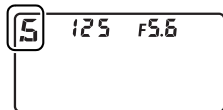

### 2 Choose a shutter speed.

Rotate the main command dial while the exposure meters are on to choose the desired shutter speed. Shutter speed can be set to “x 250” or to values between 30 s (30'') and 1/8,000 s (8000). Use slow shutter speeds to suggest motion by blurring moving objects, fast shutter speeds to “freeze” motion.

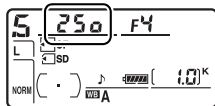

Fast shutter speed (1/1,600 s)



Slow shutter speed (1/6 s)

### 3 Frame a photograph, focus, and shoot.

#### See Also

See page 380 for information on what to do if flashing “b u l b” indicator appears in the shutter-speed displays.

## **A: Aperture-Priority Auto**

In aperture-priority auto, you choose the aperture while the camera automatically selects the shutter speed that will produce the optimal exposure. To take photographs in aperture-priority auto:

### **1** Select exposure mode **A**.

Press the **MODE** button and rotate the main command dial until **A** is displayed in the viewfinder and control panel.

**MODE** button

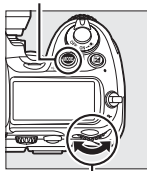

**Main** command dial

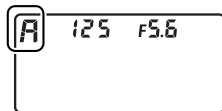

### **2** Choose an aperture.

Rotate the sub-command dial while the exposure meters are on to choose the desired aperture from values between the

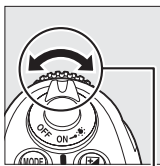

**Sub-command** dial

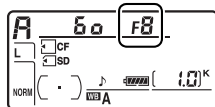

minimum and maximum for the lens. Small apertures (high f-numbers) increase depth of field (see page 105), bringing both foreground and background into focus. Large apertures (low f-numbers) soften background details in portraits or other compositions that emphasize the main subject.



**Small** aperture (f/36)



**Large** aperture (f/2.8)

### 3 Frame a photograph, focus, and shoot.



#### **Non-CPU Lenses** (📖 342)

Use the lens aperture ring to adjust aperture. If the maximum aperture of the lens has been specified using the **Non-CPU lens data** item in setup menu (📖 196) when a non-CPU lens is attached, the current f-number will be displayed in the viewfinder and control panel, rounded to the nearest full stop. Otherwise the aperture displays will show only the number of stops ( $\Delta F$ , with maximum aperture displayed as  $\Delta F0$ ) and the f-number must be read from the lens aperture ring.

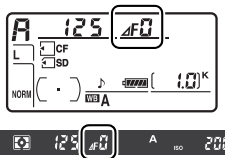

## **M: Manual**

In manual exposure mode, you control both shutter speed and aperture. To take photographs in manual exposure mode:

### **1** Select exposure mode *M*.

Press the **MODE** button and rotate the main command dial until *M* is displayed in the viewfinder and control panel.

**MODE** button

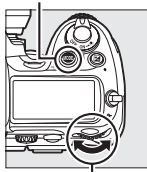

**Main command dial**

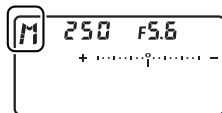

## 2 Choose aperture and shutter speed.

While the exposure meters are on, rotate the main command dial to choose a shutter speed, and the sub-command dial to set aperture. Shutter speed can be set “x 250” or to values between 30 s and  $1/8,000$  s, or the shutter can be held open indefinitely for a long time-exposure (b, L, □ 114).

Aperture can be set to values between the minimum and maximum values for the lens. Check exposure in the exposure indicators (see page 113), and continue to adjust shutter speed and aperture until the desired exposure is achieved.

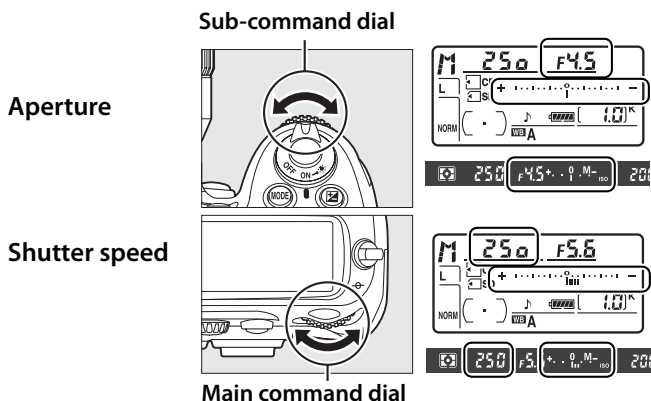

## 3 Frame a photograph, focus, and shoot.

Shutter speed:  $1/250$  s;  
aperture: f/8





### AF Micro NIKKOR Lenses



*Provided that an external exposure meter is used, the exposure ratio need only be taken into account when the lens aperture ring is used to set aperture.*

## Exposure Indicators

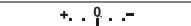
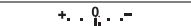
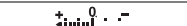
The exposure indicators in the control panel and viewfinder show whether the photograph would be under- or over-exposed at current settings (if **Lo** or **Hi** is displayed in **S** or **M** modes, the indicators show the amount of under- or over-exposure). Depending on the option chosen for Custom Setting b2 (**EV steps for exposure ctrl.**,  270), the amount of under- or over-exposure is shown in increments of  $\frac{1}{3}$  EV,  $\frac{1}{2}$  EV, or 1 EV. If the limits of the exposure metering system are exceeded, the displays will flash.

Custom Setting b2 set to 1/3 step			
	Optimal exposure	Underexposed by $\frac{1}{3}$ EV	Overexposed by over 2 EV
Control panel			
Viewfinder			

## Reverse Indicators

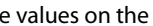
If  (+0-) is selected for Custom Setting f11 (**Reverse indicators**,  299), the exposure indicators in the viewfinder, control panel, and information display are displayed with positive values on the left and negative values on the right. Select  (-0+) to display negative values on the left and positive values on the right.



# Long Time-Exposures

At a shutter speed of  $b_{\infty}$ , the shutter will remain open while the shutter-release button is held down. Use for long time-exposure photographs of moving lights, the stars, night scenery, or fireworks. A tripod and optional remote cord (📖 356) are recommended to prevent blur.

## 1 Ready the camera.

Mount the camera on a tripod or place it on a stable, level surface. If you are using an optional remote cord, attach it to the camera. If you are not using a remote cord, choose **On** for Custom Setting d10 (**Exposure delay mode**, 📖 278) to prevent blur when the camera shutter-release button is pressed.

### Long Time-Exposures

Nikon recommends using a fully-charged EN-EL3e battery or an optional EH-5a or EH-5 AC adapter to prevent loss of power while the shutter is open. Note that noise and distortion may be present in long exposures; before shooting, choose **On** for the **Long exp. NR** option in the shooting menu (📖 258).

## 2 Select exposure mode M.

Press the **MODE** button and rotate the main command dial until **M** is displayed in the viewfinder and control panel.

**MODE** button

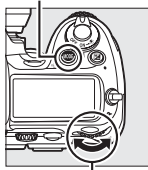

**Main command dial**

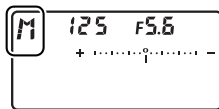



---

### 3 Choose a shutter speed.

While the exposure meters are active, rotate the main command dial until “bulb” appears in the shutter-speed displays. The exposure indicators do not appear when “bulb” is selected.

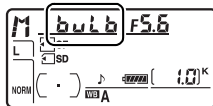

---

### 4 Press the shutter-release button all the way down.

Press the shutter-release button on the camera or remote cord all the way down. The shutter will remain open while the shutter-release button is pressed.

---

### 5 Release the shutter-release button.

Remove your finger from the shutter-release button to record the photograph.



Shutter speed: 35 s; aperture: f/25



# Autoexposure (AE) Lock

Use autoexposure lock to recompose photographs after metering exposure.

## 1 Select center-weighted or spot metering (☞ 102).

Matrix metering will not produce the desired results with autoexposure lock. If using center-weighted metering, select the center focus point with the multi selector (☞ 78).

Metering selector

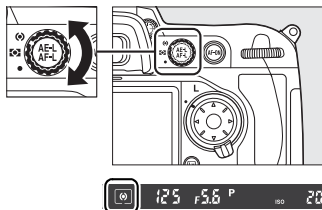

## 2 Lock exposure.

Position the subject in the selected focus point and press the shutter-release button halfway. With the shutter-release button pressed halfway and the subject positioned in the focus point, press the **AE-L/AF-L** button to lock exposure (and focus, except in manual focus mode). Confirm that the in-focus indicator (●) appears in the viewfinder.

Shutter-release button

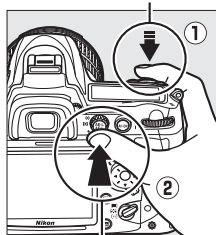

AE-L/AF-L button

While exposure lock is in effect, an **AE-L** indicator will appear in the viewfinder.



### 3 Recompose the photograph.

Keeping the **AE-L/AF-L** button pressed, recompose the photograph and shoot.

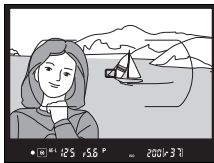

#### Metered Area

In spot metering, exposure will be locked at the value metered in a 3-mm (0.12 in.) circle centered on the selected focus point. In center-weighted metering, exposure will be locked at the value metered in an 8-mm circle in the center of the viewfinder.



#### Adjusting Shutter Speed and Aperture

While exposure lock is in effect, the following settings can be changed without altering the metered value for exposure:

Exposure mode	Setting
P	Shutter speed and aperture (flexible program;  107)
S	Shutter speed
A	Aperture

The new values can be confirmed in the viewfinder and control panel. Note that the metering method can not be changed while exposure lock is in effect (changes to metering take effect when the lock is released).

#### See Also

If **On** is selected for Custom Setting c1 (**Shutter-release button AE-L**,  273), exposure will lock when the shutter-release button is pressed halfway. For information on changing the role of the **AE-L/AF-L** button, see Custom Setting f7 (**Assign AE-L/AF-L button**,  296).



# Exposure Compensation

Exposure compensation is used to alter exposure from the value suggested by the camera, making pictures brighter or darker.

In exposure mode *M*, only the exposure information shown in the exposure indicator is affected; shutter speed and aperture do not change.

To choose a value for exposure compensation, press the  button and rotate the main command dial until the desired value is displayed in the control panel or viewfinder.

 button

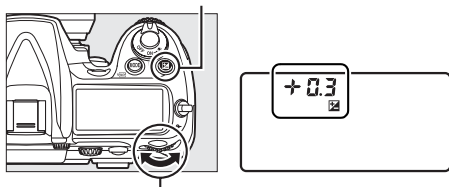

Main command dial

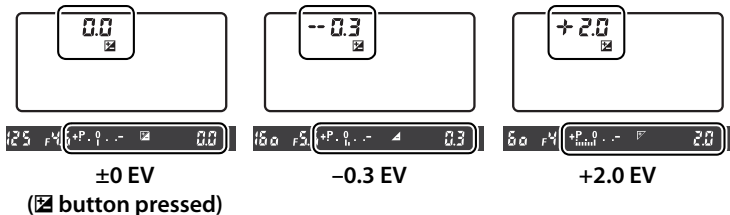

Exposure compensation can be set to values between  $-5$  EV (underexposure) and  $+5$  EV (overexposure) in increments of  $1/3$  EV. In general, choose positive values to make the subject brighter, negative values to make it darker.





-1 EV



No exposure compensation



+1 EV

At values other than  $\pm 0.0$ , the 0 at the center of the exposure indicators will flash and a  icon will be displayed in the control panel and viewfinder after you release the  button. The current value for exposure compensation can be confirmed in the exposure indicator by pressing the  button.

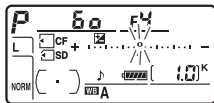



Normal exposure can be restored by setting exposure compensation to  $\pm 0.0$ . Exposure compensation is not reset when the camera is turned off.

### Using a Flash

When a flash is used, exposure compensation affects both background exposure and flash level.

### See Also

For information on choosing the size of the increments available for exposure compensation, see Custom Setting b3 (**Exp comp/fine tune**,  270). For information on making adjustments to exposure compensation without pressing the  button, see Custom Setting b4 (**Easy exposure compensation**,  271). For information on automatically varying exposure, white balance, or Active D-Lighting, see page 120.

# Bracketing

Bracketing automatically varies exposure, flash level, **Active D-Lighting (ADL)**, or white balance slightly with each shot, “bracketing” the current value. Choose in situations in which it is difficult to set exposure, Active D-Lighting, or white balance and there is not time to check results and adjust settings with each shot, or to experiment with different settings for the same subject.

## ■ **Exposure and Flash Bracketing**

To vary exposure and/or flash level over a series of photographs:

### 1 **Select flash or exposure bracketing.**

To display the menus, press the **MENU** button. Select Custom Setting e5 (**Auto bracketing set**) in the Custom Settings menu, highlight an option, and press **OK**. Choose **AE & flash** to vary both exposure and flash level, **AE only** to vary only exposure, or **Flash only** to vary only flash level.

#### MENU button

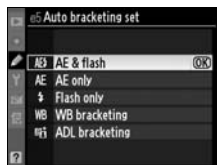
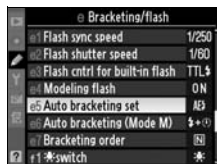
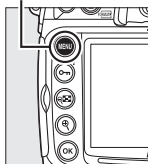

## 2 Choose the number of shots.

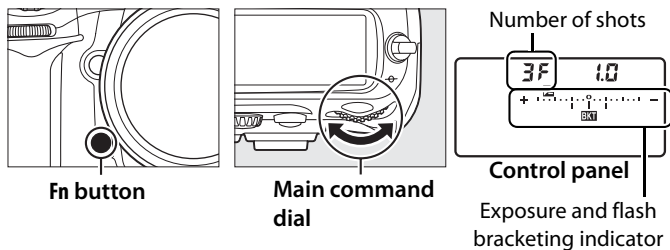

Pressing the **Fn** button, rotate the main command dial to choose the number of shots in the bracketing sequence. The number of shots is shown in the control panel.



At settings other than zero, a **BKT** icon and exposure and flash bracketing indicator will be displayed in the control panel, and a  icon will blink in the viewfinder and control panel.



### See Also

Changes to bracketing settings can be made using the **Fn** button (the default setting, see Custom Setting f5, **Assign Fn button**,  292), the depth-of-field preview button (Custom setting f6, **Assign preview button**),  296), or the **AE-L/AF-L** button (Custom Setting f7, **Assign AE-L/AF-L button**,  296). Note that some “button press” options can not be combined with options using “+dials.” The explanation that follows assumes that bracketing is assigned to the **Fn** button.

### 3 Select an exposure increment.

Pressing the **Fn** button, rotate the sub-command dial to choose the exposure increment.

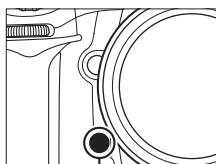

**Fn button**

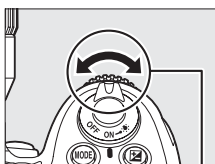

**Sub-command dial**

Exposure increment

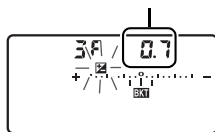

**Control panel**

At default settings, the size of the increment can be chosen from  $\frac{1}{3}$ ,  $\frac{2}{3}$ , and 1 EV. The bracketing programs with an increment of  $\frac{1}{3}$  EV are listed below.

Control panel display	No. of shots	Bracketing order (EVs)
0F 0.3 + ..... 0 ..... -	0	0
+ 3F 0.3 + ..... i ..... -	3	+0.3/0/+0.7
-- 3F 0.3 + ..... i ..... -	3	-0.3/-0.7/0
+ 2F 0.3 + ..... i ..... -	2	0/+0.3
-- 2F 0.3 + ..... i ..... -	2	0/-0.3
3F 0.3 + ..... i ..... -	3	0/-0.3/+0.3
5F 0.3 + ..... i ..... -	5	0/-0.7/-0.3/+0.3/+0.7
7F 0.3 + ..... i ..... -	7	0/-1.0/-0.7/-0.3/+0.3/ +0.7/+1.0
9F 0.3 + ..... i ..... -	9	0/-1.3/-1.0/-0.7/-0.3/ +0.3/+0.7/+1.0/+1.3

#### See Also

For information on choosing the size of the exposure increment, see Custom Setting b2 (**EV steps for exposure ctrl.**, 270).

For information on choosing the order in which bracketing is performed, see Custom Setting e7 (**Bracketing order**, 290).



## 4 Frame a photograph, focus, and shoot.



The camera will vary exposure and/or flash level shot-by-shot according to the bracketing program selected. Modifications to exposure are added to those made with exposure compensation (see page 118), making it possible to achieve exposure compensation values of more than 5 EV.

While bracketing is in effect, a bracketing progress indicator will be displayed in the control panel. A segment will disappear from the indicator after each shot.

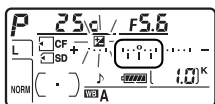

No. shots: 3; increment: 0.7

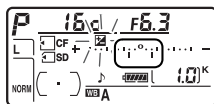

Display after first shot



Exposure increment:  
0 EV



Exposure increment:  
-1 EV



Exposure increment:  
+1 EV



## ■ ■ **Canceling Bracketing**

To cancel bracketing, press the **Fn** button and rotate the main command dial until the number of shots in the bracketing sequence is zero (0F) and **BKT** is no longer displayed in the control panel. The program last in effect will be restored the next time bracketing is activated. Bracketing can also be cancelled by performing a two-button reset (□ 182), although in this case the bracketing program will not be restored the next time bracketing is activated.

### **Exposure and Flash Bracketing**

In continuous low speed and continuous high speed modes, shooting will pause after the number of shots specified in the bracketing program have been taken. Shooting will resume the next time the shutter-release button is pressed. In other modes, one shot will be taken each time the shutter-release button is pressed.

If the memory card fills before all shots in the sequence have been taken, shooting can be resumed from the next shot in the sequence after the memory card has been replaced or shots have been deleted to make room on the memory card. If the camera is turned off before all shots in the sequence have been taken, bracketing will resume from the next shot in the sequence when the camera is turned on.

### **Exposure Bracketing**

The camera modifies exposure by varying shutter speed and aperture (programmed auto), aperture (shutter-priority auto), or shutter speed (aperture-priority auto, manual exposure mode). If **On** is selected for **ISO sensitivity settings > ISO sensitivity auto control** in modes **P**, **S**, and **A**, the camera will automatically vary ISO sensitivity for optimum exposure when the limits of the camera exposure system are exceeded. Custom Setting e6 (**Auto bracketing (mode M)**, □ 290) can be used to change how the camera performs exposure and flash bracketing in manual exposure mode. Bracketing can be performed by varying flash level together with shutter speed and/or aperture, or by varying flash level alone.

## ■ ■ White Balance Bracketing

The camera creates multiple copies of each photograph, each with a different white balance. For more information on white balance, see page 133.

### 1 Select white balance bracketing.

Choose **WB bracketing** for Custom Setting e5 **Auto bracketing set**.

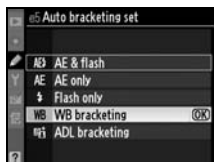

### 2 Choose the number of shots.

Pressing the **Fn** button, rotate the main command dial to choose the number of shots in the bracketing sequence. The number of shots is shown in the control panel.

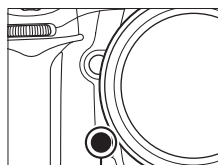

F<sub>n</sub> button

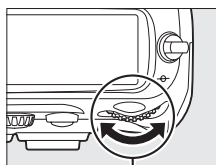

Main command dial

Number of shots

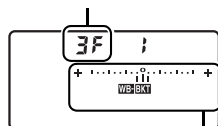

Control panel

WB bracketing indicator

At settings other than zero, a **WB-BKT** icon and WB bracketing indicator will appear in the control panel.

### 3 Select a white balance increment.

Pressing the **Fn** button, rotate the sub-command dial to choose the white balance adjustment. Each increment is roughly equivalent to 5 mired.

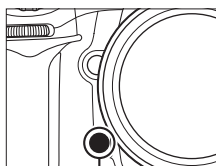

**Fn** button

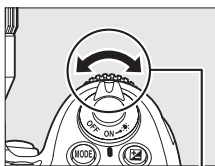

**Sub-command dial**

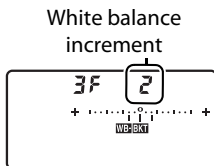

**Control panel**

Choose from increments of 1 (5 mired), 2 (10 mired), or 3 (15 mired). Higher **B** values correspond to increased amounts of blue, higher **A** values to increased amounts of amber (□ 138). The bracketing programs with an increment of 1 are listed below.

Control panel display	No. of shots	White balance increment	Bracketing order (EVs)
0F 1	0	1	0
b3F 1	3	1 B	1 B / 0 / 2 B
A3F 1	3	1 A	1 A / 2 A / 0
b2F 1	2	1 B	0 / 1 B
A2F 1	2	1 A	0 / 1 A
3F 1	3	1 A, 1 B	0 / 1 A / 1 B
5F 1	5	1 A, 1 B	0 / 2 A / 1 A / 1 B / 2 B
7F 1	7	1 A, 1 B	0 / 3 A / 2 A / 1 A / 1 B / 2 B / 3 B
9F 1	9	1 A, 1 B	0 / 4 A / 3 A / 2 A / 1 A / 1 B / 2 B / 3 B / 4 B

#### See Also

See page 139 for a definition of “mired.”

## 4 Frame a photograph, focus, and shoot.



Each shot will be processed to create the number of copies specified in the bracketing program, and each copy will have a different white balance. Modifications to white balance are added to the white balance adjustment made with white balance fine-tuning.

If the number of shots in the bracketing program is greater than the number of exposures remaining, the exposure count displays in the control panel and viewfinder will flash and the shutter release will be disabled. Shooting can begin when a new memory card is inserted.

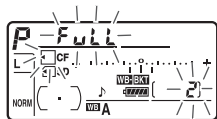

## ■ ■ **Canceling Bracketing**

To cancel bracketing, press the **Fn** button and rotate the main command dial until the number of shots in the bracketing sequence is zero (0 F) and **WB:BRKT** is no longer displayed in the control panel. The program last in effect will be restored the next time bracketing is activated. Bracketing can also be cancelled by performing a two-button reset (□ 182), although in this case the bracketing program will not be restored the next time bracketing is activated.



### **White Balance Bracketing**

White balance bracketing is not available at an image quality of NEF (RAW). Selecting **NEF (RAW)**, **NEF (RAW)+JPEG fine**, **NEF (RAW)+JPEG normal**, or **NEF (RAW)+JPEG basic** cancels white balance bracketing.

White balance bracketing affects only color temperature (the amber-blue axis in the white balance fine-tuning display, □ 138). No adjustments are made on the green-magenta axis.

In self-timer mode (□ 91), the number of copies specified in the white-balance program will be created each time the shutter is released.

If the camera is turned off while the memory card access lamp is lit, the camera will power off only after all photographs in the sequence have been recorded.

## ■ ■ ADL Bracketing

The camera varies Active D-Lighting over a series of exposures. For more information on Active D-Lighting, see page 164.

### 1 Select ADL bracketing.

Choose **ADL bracketing** for Custom Setting e5 **Auto bracketing set**.

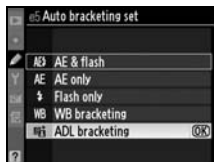

### 2 Choose the number of shots.

Pressing the **Fn** button, rotate the main command dial to choose the number of shots in the bracketing sequence. The number of shots is shown in the control panel.

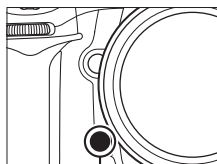

F<sub>n</sub> button

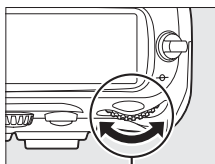

Main command dial

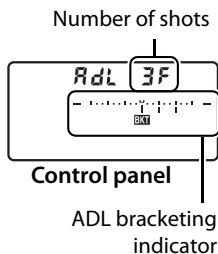

At settings other than zero, an **ADL** icon and ADL bracketing indicator will appear in the control panel. Choose two shots to take one photograph with Active D-Lighting off and another at a selected value. Choose three to five shots to take a series of photographs with Active D-Lighting set to **Off**, **Low**, and **Normal** (three shots), **Off**, **Low**, **Normal**, and **High** (four shots), or **Off**, **Low**, **Normal**, **High**, and **Extra High** (five shots). If you choose more than two shots, proceed to Step 4.

### 3 Select Active D-Lighting.

Pressing the **Fn** button, rotate the sub-command dial to choose Active D-Lighting.

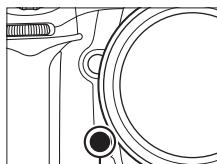



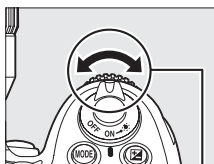







**Fn** button

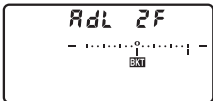

**Sub-command**  
dial

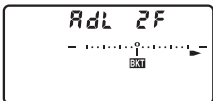
Active D-Lighting is shown in the control panel.

Control panel display	Active D-Lighting
	 AUTO      Auto
	 L      Low
	 N      Normal
	 H      High
	 H+      Extra high



## 4 Frame a photograph, focus, and shoot.



The camera will vary Active D-Lighting shot-by-shot according to the bracketing program selected. While bracketing is in effect, a bracketing progress indicator will be displayed in the control panel. A segment will disappear from the indicator after each shot.



## ■ ■ **Canceling Bracketing**

To cancel bracketing, press the **Fn** button and rotate the main command dial until the number of shots in the bracketing sequence is zero. The program last in effect will be restored the next time bracketing is activated. Bracketing can also be cancelled by performing a two-button reset (📖 182), although in this case the bracketing program will not be restored the next time bracketing is activated.



### **ADL Bracketing**

In continuous low speed and continuous high speed modes, shooting will pause after the number of shots specified in the bracketing program have been taken. Shooting will resume the next time the shutter-release button is pressed. In other modes, one shot will be taken each time the shutter-release button is pressed.

If the memory card fills before all shots in the sequence have been taken, shooting can be resumed from the next shot in the sequence after the memory card has been replaced or shots have been deleted to make room on the memory card. If the camera is turned off before all shots in the sequence have been taken, bracketing will resume from the next shot in the sequence when the camera is turned on.



# White Balance

– *Keeping Colors True*







The color of light reflected from an object varies with the color of the light source. The human brain is able to adapt to changes in the color of the light source, with the result that white objects appear white whether seen in the shade, direct sunlight, or under incandescent lighting. Unlike the film used in film cameras, digital cameras can mimic this adjustment by processing images according to the color of the light source. This is known as “white balance.” This chapter covers white balance settings.

<b>White Balance Options.....</b>	<b>134</b>
<b>Fine-Tuning White Balance.....</b>	<b>137</b>
<b>Choosing a Color Temperature.....</b>	<b>141</b>
<b>Preset Manual .....</b>	<b>142</b>



# White Balance Options

For natural coloration, choose a white balance setting that matches the light source before shooting. The following options are available:

Option	Color temp.*	Description
AUTO Auto	3,500–8,000 K	White balance is adjusted automatically. For best results, use type G or D lens. If built-in or optional flash fires, results are adjusted for flash.
 Incandescent	3,000 K	Use under incandescent lighting.
 Fluorescent		Use with:
Sodium-vapor lamps	2,700 K	• Sodium-vapor lighting (found in sports venues).
Warm-white fluorescent	3,000 K	• Warm-white fluorescent lights.
White fluorescent	3,700 K	• White fluorescent lights.
Cool-white fluorescent	4,200 K	• Cool-white fluorescent lights.
Day white fluorescent	5,000 K	• Daylight white fluorescent lights.
Daylight fluorescent	6,500 K	• Daylight fluorescent lights.
High temp. mercury-vapor	7,200 K	• High color temperature light sources (e.g. mercury-vapor lamps).
 Direct sunlight	5,200 K	Use with subjects lit by direct sunlight.
 Flash	5,400 K	Use with built-in or optional flash.
 Cloudy	6,000 K	Use in daylight under overcast skies.
 Shade	8,000 K	Use in daylight with subjects in the shade.
 Choose color temp.	2,500–10,000 K	Choose color temperature from list of values (📖 141).
PRE Preset manual	—	Use subject, light source, or existing photograph as reference for white balance (📖 142).

\* All values are approximate. Fine-tuning set to 0.

Auto white balance is recommended with most light sources. If the desired results can not be achieved with auto white balance, choose an option from the list above or use preset white balance.

White balance can be selected by pressing the **WB** button and rotating the main command dial until the desired setting is displayed in the control panel.

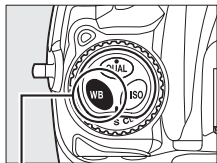

WB button

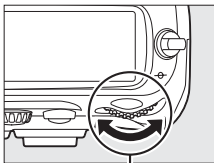

Main command dial

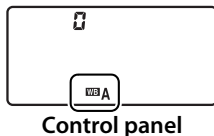

Control panel

### The White Balance Menu

White balance can also be adjusted using the **White balance** option in the shooting menu (☞ 253).



### (Fluorescent)

Selecting  (fluorescent) with the **WB** button and main command dial selects the type of bulb chosen for the **Fluorescent** option in the white balance menu (☞ 253).

### Studio Flash Lighting

Auto white balance may not produce the desired results with large studio flash units. Use preset white balance or set white balance to **Flash** and use fine tuning to adjust white balance.

### See Also

When **WB bracketing** is selected for Custom Setting e5 (**Auto bracketing set**, ☞ 289), the camera will create several images each time the shutter is released. White balance will be varied with each image, “bracketing” the value currently selected for white balance. See page 120 for more information.

### **Color Temperature**

The perceived color of a light source varies with the viewer and other conditions. Color temperature is an objective measure of the color of a light source, defined with reference to the temperature to which an object would have to be heated to radiate light in the same wavelengths. While light sources with a color temperature in the neighborhood of 5,000–5,500 K appear white, light sources with a lower color temperature, such as incandescent light bulbs, appear slightly yellow or red. Light sources with a higher color temperature appear tinged with blue.

# Fine-Tuning White Balance

White balance can be “fine tuned” to compensate for variations in the color of the light source or to introduce a deliberate color cast into an image. White balance is fine tuned using the **White balance** option in the shooting menu or by pressing the **WB** button and rotating the sub-command dial.

## ■ ■ The White Balance Menu

### 1 Select a white balance option.

To display the menus, press the **MENU** button.

Select **White balance** in the shooting menu, then highlight a white balance

option and press ►. If an option other than **Fluorescent**, **Choose color temp.**, or **Preset manual** is selected, proceed to Step 2. If **Fluorescent** is selected, highlight a lighting type and press ►. If **Choose color temp.** is selected, highlight a color temperature and press ►. If **Preset manual** is selected, choose a preset as described on page 150 before proceeding.

MENU button

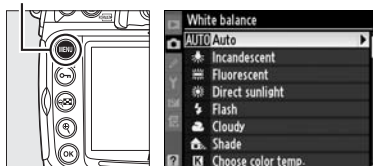

## 2 Fine tune white balance.

Use the multi selector to fine-tune white balance. White balance can be fine-tuned on the amber (A)–blue (B) axis and the green (G)–magenta (M) axis. The horizontal (amber–blue) axis corresponds to color temperature, with each increment equivalent to about 5 mired. The vertical (green–magenta) axis has the similar effects to the corresponding color compensation (CC) filters.

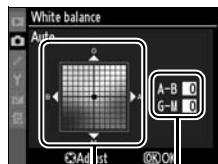

Coordinates Adjustment

Increase green



Increase magenta

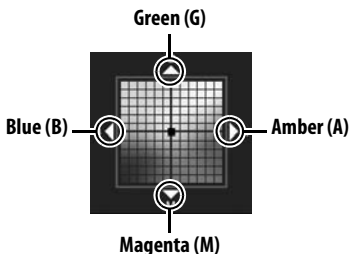

Increase blue

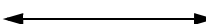

Increase amber

WB

## 3 Press **OK**.

Press **OK** to save settings and return to the shooting menu. If white balance has been fine-tuned on the A-B axis, a **◀▶** icon will be displayed in the control panel.

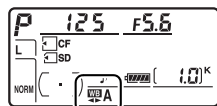



### **White Balance Fine Tuning**

The colors on the fine-tuning axes are relative, not absolute. For example, moving the cursor to **B** (blue) when a “warm” setting such as  (incandescent) is selected for white balance will make photographs slightly “colder” but will not actually make them blue.

### **Color Temperature Fine-Tuning**

When **Choose color temp.** is selected, you can view the color temperature while fine-tuning white balance.

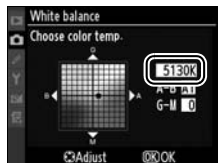

### **“Mired”**

Any given change in color temperature produces a greater difference in color at low color temperatures than it would at higher color temperatures. For example, a change of 1000 K produces a much greater change in color at 3000 K than at 6000 K. Mired, calculated by multiplying the inverse of the color temperature by  $10^6$ , is a measure of color temperature that takes such variation into account, and as such is the unit used in color-temperature compensation filters. E.g.:

- 4000 K–3000 K (a difference of 1000 K)=83 mired
- 7000 K–6000 K (a difference of 1000 K)=24 mired

## ■ The WB Button

At settings other than **☑** (**Choose color temp.**) and **PRE** (**Preset manual**), the **WB** button can be used to fine-tune white balance on the amber (A)–blue (B) axis (☐ 138; to fine-tune white balance when **☑** or **PRE** is selected, use the shooting menu as described on page 137). Six settings in both directions are available; each increment is equivalent to about 5 mired (☐ 139). Press the **WB** button and rotate the sub-command dial until the desired value is displayed in the control panel. Rotating the sub-command dial to the left increases the amount of amber (A). Rotating the sub-command dial to the right increases the amount of blue (B). At settings other than 0, a ◀▶ icon appears in the control panel.

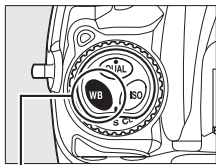

WB button

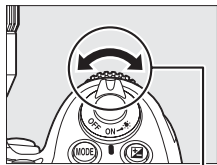

Sub-command dial

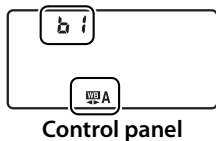

Control panel

# Choosing a Color Temperature

When **☑ (Choose color temp.)** is selected for white balance, color temperature can be selected by pressing the **WB** button and rotating the sub-command dial. The color temperature is displayed in the control panel:

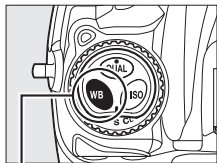

WB button

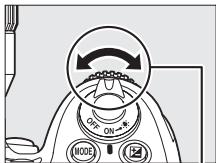

Sub-command dial

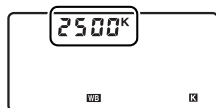

Control panel

## **☑ Choose Color Temperature**

Note that the desired results will not be obtained with flash or fluorescent lighting. Choose **⚡ (Flash)** or **☀ (Fluorescent)** for these sources. With other light sources, take a test shot to determine if the selected value is appropriate.

## **✎ The White Balance Menu**

Color temperature can also be selected in the white balance menu. Note that the color temperature with the **WB** button and the sub-command dial replaces the value selected in the white balance menu.



# Preset Manual

Preset manual is used to record and recall custom white balance settings for shooting under mixed lighting or to compensate for light sources with a strong color cast. Two methods are available for setting preset white balance:

Method	Description
<b>Direct measurement</b>	Neutral gray or white object is placed under lighting that will be used in final photograph and white balance is measured by camera (📖 144).
<b>Copy from existing photograph</b>	White balance is copied from photo on memory card (📖 148).

The camera can store up to five values for preset white balance in presets d-0 through d-4. A descriptive comment can be added to any white balance preset (☞ 152).

#### d-0

Stores last value measured for white balance (☞ 144). This preset is overwritten when a new value is measured.

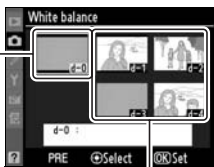

#### d-1-d-4

Store values copied from d-0 (☞ 147).

Store values copied from images on memory card (☞ 148).

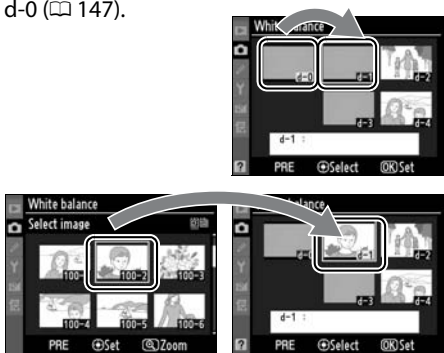

### White Balance Presets

Changes to white balance presets apply to all shooting menu banks (☞ 254). A confirmation dialog will be displayed if the user attempts to change a white balance preset created in another shooting menu bank (no warning is displayed for preset d-0).

## ■ Measuring a Value for White Balance

### 1 Light a reference object.

Place a neutral gray or white object under the lighting that will be used in the final photograph. In studio settings, a standard gray panel can be used as a reference object. Note that exposure is automatically increased by 1 EV when measuring white balance; in exposure mode *M*, adjust exposure so that the exposure indicator shows  $\pm 0$  (□ 113).

### 2 Set white balance to PRE (Preset manual).

Press the **WB** button and rotate the main command dial until **PRE** is displayed in the control panel.

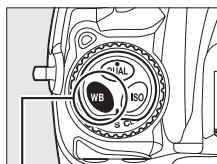

WB button

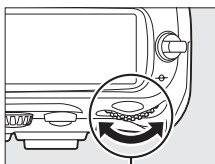

Main command dial



Control panel

### 3 Select direct measurement mode.

Release the **WB** button briefly and then press the button until the **PRE** icon in the control panel starts to flash. A flashing **P r E** will also appear in the control panel and viewfinder. The displays will flash for about six seconds.

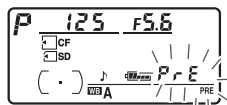

Control panel



Viewfinder

## 4 Measure white balance.



Before the indicators stop flashing, frame the reference object so that it fills the viewfinder and press the shutter-release button all the way down. The camera will measure a value for white balance and store it in preset d-0. No photograph will be recorded; white balance can be measured accurately even when the camera is not in focus.

## 5 Check the results.

If the camera was able to measure a value for white balance, **Good** will flash in the control panel for about six seconds, while the viewfinder will show a flashing **ūd**.

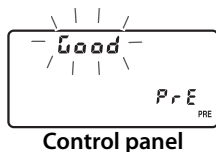

Control panel



Viewfinder

If lighting is too dark or too bright, the camera may be unable to measure white balance. A flashing **no ūd** will appear in the control panel and viewfinder for about six seconds. Press the shutter-release button halfway to return to Step 4 and measure white balance again.

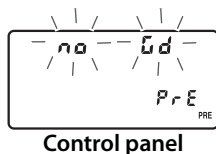

Control panel



Viewfinder



## 6 Select preset d-0.

If the new value for preset white balance will be used immediately, select preset d-0 by pressing the **WB** button and rotating the sub-command dial until d-0 is displayed in the control panel.

### ✔ Direct Measurement Mode

If no operations are performed while the displays are flashing, direct measurement mode will end in the time selected for Custom Setting c2 (**Auto meter-off delay**, □ 273).

### ✎ Preset d-0

The new value for white balance will be stored in preset d-0, automatically replacing the previous value for this preset (no confirmation dialog will be displayed). A thumbnail will be displayed in the preset white balance list (□ 147).



To use the new value for white balance, select preset d-0 (if no value has been measured for white balance before d-0 is selected, white balance will be set to a color temperature of 5,200 K, the same as **Direct sunlight**). The new white balance value will remain in preset d-0 until white balance is measured again. By copying preset d-0 to one of the other presets before measuring a new value for white balance, up to five white balance values can be stored (□ 147).



## ■ Copying White Balance from d-0 to Presets d-1–d-4

Follow the steps below to copy a measured value for white balance from d-0 to any of the other presets (d-1–d-4).

### 1 Select PRE (Preset manual).

Press the **MENU** button and select **White balance** in the shooting menu. Highlight **Preset manual** and press **▶**.

MENU button

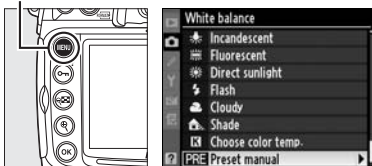

### 2 Select a destination.

Highlight the destination preset (d-1 to d-4) and press the center of the multi-selector.



### 3 Copy d-0 to the selected preset.

Highlight **Copy d-0** and press **OK**. If comment has been created for d-0 (☞ 152), the comment will be copied to the comment for the selected preset.

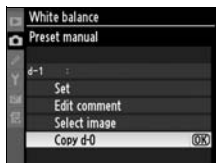

## ■ Copying White Balance from a Photograph (d-1–d-4 Only)

Follow the steps below to copy a value for white balance from an existing photograph to a selected preset (d-1–d-4 only). Existing white balance values can not be copied to preset d-0.

### 1 Select PRE (Preset manual).

Highlight **Preset manual** in the white balance menu and press **▶**.

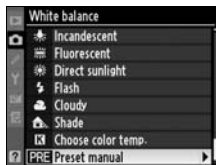

### 2 Select a destination.

Highlight the destination preset (d-1 to d-4) and press the center of the multi selector.



### 3 Choose Select image.

Highlight **Select image** and press **▶**.

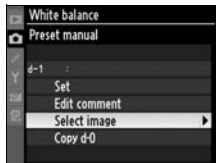

## 4 Highlight a source image.

Highlight the source image.



To view the highlighted image full frame, press and hold the  button.

 button

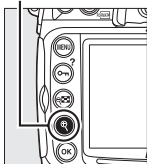

To view images in other locations, press  and select the desired card and folder (□ 217).

 button

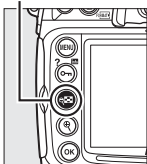



## 5 Copy white balance.

Press the center of the multi selector to copy the white balance value for the highlighted photograph to the selected preset. If the highlighted photograph has a comment (□ 303), the comment will be copied to the comment for the selected preset.



### Choosing a White Balance Preset

Press  to highlight the current white balance preset (d-0 – d-4) and press  to select another preset.

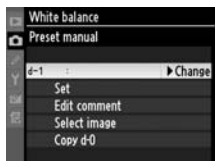

## ■ Selecting a White Balance Preset

To set white balance to a preset value:

### 1 Select PRE (Preset manual).

Highlight **Preset manual** in the white balance menu and press ►.

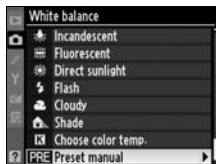

### 2 Select a preset.

Highlight the desired preset and press the center of the multi selector. To select the highlighted preset and display fine tuning menu (☰ 138) without completing the next step, press Ⓢ instead of pressing the center of the multi selector.



### 3 Select Set.

Highlight **Set** and press ►. Fine tuning menu for the selected white balance preset is displayed (☰ 138).



### **Selecting a White Balance Preset: the WB Button**

At a setting of **PRE (Preset manual)**, presets can also be selected by pressing the **WB** button and rotating the sub-command dial. The current preset is displayed in the control panel while the **WB** button is pressed.

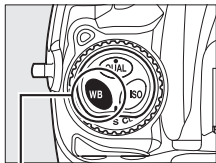

**WB button**

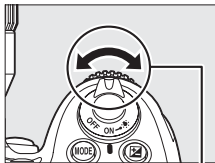

**Sub-command dial**

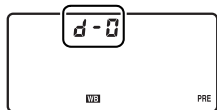

**Control panel**

## ■ Entering a Comment

Follow the steps below to enter a descriptive comment of up to thirty-six characters for a selected white balance preset.

### 1 Select PRE (Preset manual).

Highlight **Preset manual** in the white balance menu and press **▶**.

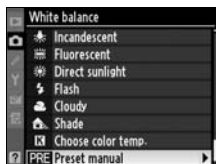

### 2 Select a preset.

Highlight the desired preset and press the center of the multi selector.



### 3 Select Edit comment.

Highlight **Edit comment** and press **▶**.



### 4 Edit the comment.

Edit the comment as described on page 255.





# Image Enhancement

This chapter describes how to optimize sharpening, contrast, brightness, saturation and hue using Picture Controls, how to preserve detail in highlights and shadows using active D-Lighting, and how to choose a color space.

<b>Picture Controls .....</b>	<b>154</b>
Creating Custom Picture Controls .....	160
<b>Active D-Lighting .....</b>	<b>164</b>
<b>Color Space.....</b>	<b>166</b>







# Picture Controls

Nikon's unique Picture Control system makes it possible to share image processing settings, including sharpening, contrast, brightness, saturation, and hue, among compatible devices and software.

## Selecting a Picture Control

The camera offers a choice of preset Picture Controls. Choose a Picture Control according to the subject or type of scene.

Option	Description
 <b>Standard</b>	Standard processing for balanced results. Recommended for most situations.
 <b>Neutral</b>	Minimal processing for natural results. Choose for photographs that will later be extensively processed or retouched.
 <b>Vivid</b>	Pictures are enhanced for a vivid, photoprint effect. Choose for photographs that emphasize primary colors.
 <b>Monochrome</b>	Take monochrome photographs.

### 1 Select Set Picture Control.

To display the menus, press the **MENU** button. Highlight **Set Picture Control** in the shooting menu and press ►.

MENU button

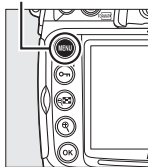

### 2 Select a Picture Control.

Highlight the desired Picture Control and press **OK**.





## **Preset Picture Controls Versus Custom Picture Controls**

The Picture Controls supplied with the camera are referred to as *preset Picture Controls*. *Custom Picture Controls* are created through modifications to existing Picture Controls using the **Manage Picture Control** option in the shooting menu (☞ 160). Custom Picture Controls can be saved to a memory card for sharing among other D300S cameras and compatible software (☞ 163).

## **Optional Picture Controls**

Additional optional Picture Controls are available for download from Nikon websites.

## **The Picture Control Indicator**

The current Picture Control is shown in the information display when the **Info** button is pressed.

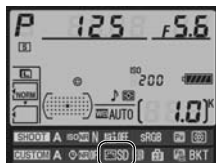

**Picture Control  
indicator**



# Modifying Existing Picture Controls

Existing preset or custom Picture Controls (📖 160) can be modified to suit the scene or the user's creative intent. Choose a balanced combination of settings using **Quick adjust**, or make manual adjustments to individual settings.



## 1 Select a Picture Control.

Highlight the desired Picture Control in the **Set Picture Control** menu (📖 154) and press ▶.



## 2 Adjust settings.

Press ▲ or ▼ to highlight the desired setting and press ◀ or ▶ to choose a value (📖 157).

Repeat this step until all settings have been adjusted, or select **Quick adjust** to choose a preset combination of settings. Default settings can be restored by pressing the 🗑️ button.



## 3 Press OK.

### Modifications to Original Picture Controls

Picture Controls that have been modified from default settings are indicated by an asterisk ("\*") in the **Set Picture Control** menu.



## Picture Control Settings

Option	Description	
Quick adjust	Choose from options between <b>-2</b> and <b>+2</b> to reduce or exaggerate the effect of the selected Picture Control (note that this resets all manual adjustments). For example, choosing positive values for <b>Vivid</b> makes pictures more vivid. Not available with <b>Neutral</b> , <b>Monochrome</b> , or custom Picture Controls.	
Manual adjustments (all Picture Controls)	<b>Sharpening</b>	Control the sharpness of outlines. Select <b>A</b> to adjust sharpening automatically according to the type of scene, or choose from values between <b>0</b> (no sharpening) and <b>9</b> (the higher the value, the greater the sharpening).
	<b>Contrast</b>	Select <b>A</b> to adjust contrast automatically according to the type of scene, or choose from values between <b>-3</b> and <b>+3</b> (choose lower values to prevent highlights in portrait subjects from being “washed out” in direct sunlight, higher values to preserve detail in misty landscapes and other low-contrast subjects).
	<b>Brightness</b>	Choose <b>-1</b> for reduced brightness, <b>+1</b> for enhanced brightness. Does not affect exposure.
Manual adjustments (non-monochrome only)	<b>Saturation</b>	Control the vividness of colors. Select <b>A</b> to adjust saturation automatically according to the type of scene, or choose from values between <b>-3</b> and <b>+3</b> (lower values reduce saturation and higher values increase it).
	<b>Hue</b>	Choose negative values (to a minimum of <b>-3</b> ) to make reds more purple, blues more green, and greens more yellow, positive values (up to <b>+3</b> ) to make reds more orange, greens more blue, and blues more purple.
Manual adjustments (monochrome only)	<b>Filter effects</b>	Simulate the effect of color filters on monochrome photographs. Choose from <b>Off</b> , yellow, orange, red, and green (□ 158).
	<b>Toning</b>	Choose the tint used in monochrome photographs from <b>B&amp;W</b> (black-and-white), <b>Sepia</b> , <b>Cyanotype</b> (blue-tinted monochrome), <b>Red</b> , <b>Yellow</b> , <b>Green</b> , <b>Blue Green</b> , <b>Blue</b> , <b>Purple Blue</b> , <b>Red Purple</b> (□ 159).



## ✔ Active D-Lighting



**Contrast** and **Brightness** can not be adjusted when Active D-Lighting (☐164) is on. Any manual adjustments currently in effect will be lost when Active D-Lighting is turned on.

## ✔ "A" (Auto)

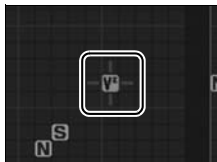
Results for auto contrast and saturation vary with exposure and the position of the subject in the frame. Use a type G or D lens for best results. The icons for Picture Controls that use auto contrast and saturation are displayed in green in the Picture Control grid, and lines appear parallel to the axes of the grid.



## ✍ The Picture Control Grid

Pressing the  button in Step 2 displays a Picture Control grid showing the contrast and saturation for the selected Picture Control in relation to the other Picture Controls (only contrast is displayed when **Monochrome** is selected). Release the  button to return to the Picture Control menu.



## ✍ Previous Settings

The line under the value display in the Picture Control setting menu indicates the previous value for the setting. Use this as a reference when adjusting settings.

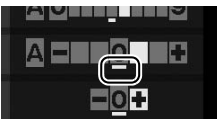

## ✍ Filter Effects (Monochrome Only)

The options in this menu simulate the effect of color filters on monochrome photographs. The following filter effects are available:

Option		Description
Y	Yellow	Enhances contrast. Can be used to tone down the brightness of the sky in landscape photographs. Orange produces more contrast than yellow, red more contrast than orange.
O	Orange	
R	Red	
G	Green	Softens skin tones. Can be used for portraits.

Note that the effects achieved with **Filter effects** are more pronounced than those produced by physical glass filters.

### **Toning (Monochrome Only)**

Pressing ▼ when **Toning** is selected displays saturation options. Press ◀ or ▶ to adjust saturation. Saturation control is not available when **B&W** (black-and-white) is selected.



### **Custom Picture Controls**

The options available with custom Picture Controls are the same as those on which the custom Picture Control was based.



# Creating Custom Picture Controls

The Picture Controls supplied with the camera can be modified and saved as custom Picture Controls.

## 1 Select Manage Picture Control.

To display the menus, press the **MENU** button. Highlight **Manage Picture Control** in the shooting menu and press ►.

MENU button

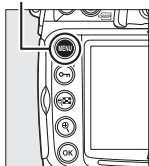

## 2 Select Save/edit.

Highlight **Save/edit** and press ►.





## 3 Select a Picture Control.

Highlight an existing Picture Control and press ►, or press **OK** to proceed to step 5 to save a copy of the highlighted Picture Control without further modification.



## 4 Edit the selected Picture Control.

See page 157 for more information. To abandon any changes and start over from default settings, press the  button. Press  when settings are complete.



## 5 Select a destination.

Choose a destination for the custom Picture Control (C-1 through C-9) and press .



## 6 Name the Picture Control.

The text-entry dialog shown at right will be displayed. By default, new Picture



Keyboard area

Name area

Controls are named by adding a two-digit number (assigned automatically) to the name of the existing Picture Control. This name can be edited to create a new name of up to 19 characters as described on page 255.

The new Picture Control will appear in the Picture Control list.



### **Manage Picture Control > Rename**

Custom Picture Controls can be renamed at any time using the **Rename** option in the **Manage Picture Control** menu.

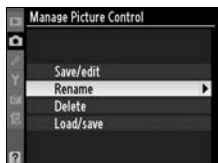

### **Manage Picture Control > Delete**

The **Delete** option in the **Manage Picture Control** menu can be used to delete selected custom Picture Controls when they are no longer needed.

### **The Original Picture Control Icon**

The original preset Picture Control on which the custom Picture Control is based is indicated by an icon in the top right corner of the edit display.

**Original Picture Control icon**





## Sharing Custom Picture Controls

Custom Picture Controls created using the Picture Control Utility available with ViewNX or optional software such as Capture NX 2 can be copied to a memory card and loaded into the camera, or custom Picture Controls created with the camera can be copied to the memory card to be used in compatible cameras and software and then deleted when no longer needed (if two memory cards are inserted, the card in the primary slot will be used;  72).

To copy custom Picture Controls to or from the memory card, or to delete custom Picture Controls from the memory card, highlight **Load/Save** in the **Manage Picture Control** menu and press . The following options will be displayed:



- **Copy to camera:** Copy custom Picture Controls from the memory card to custom Picture Controls C-1 through C-9 on the camera and name them as desired.

- **Delete from card:** Delete selected custom Picture Controls from the memory card. The confirmation dialog shown at right will be displayed before a Picture Control is deleted; to delete the selected Picture Control, highlight **Yes** and press .



- **Copy to card:** Copy a custom Picture Control (C-1 through C-9) from the camera to a selected destination (1 through 99) on the memory card.

### Saving Custom Picture Controls

Up to 99 custom Picture Controls can be stored on the memory card at any one time. The memory card can only be used to store user-created custom Picture Controls. The preset Picture Controls supplied with the camera can not be copied to the memory card, renamed, or deleted.

# Active D-Lighting

Active D-Lighting preserves details in highlights and shadows, creating photographs with natural contrast. Use for high contrast scenes, for example when photographing brightly lit outdoor scenery through a door or window or taking pictures of shaded subjects on a sunny day.



Active D-Lighting off



Active D-Lighting:  AUTO Auto



Active D-Lighting off



Active D-Lighting:  H High



To use active D-Lighting:

## 1 Select Active D-Lighting. MENU button

To display the menus, press the **MENU** button. Highlight **Active D-Lighting** in the shooting menu and press **▶**.

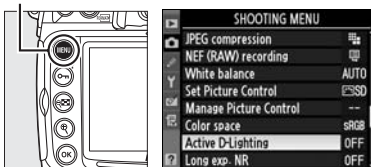

## 2 Choose an option.

Highlight **Auto**, **Extra high**, **High**, **Normal**, **Low**, or **Off** and press **OK**. If **Auto** is selected, the camera will automatically adjust Active D-Lighting according to shooting conditions (in exposure mode **M**, however, **Auto** is equivalent to **Normal**).

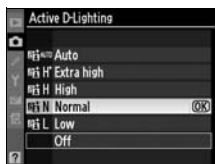

### ✓ Active D-Lighting

Matrix metering is recommended (□ 102). When Active D-Lighting is on, noise (graininess, banding, and mottling) may appear in photographs taken at high ISO sensitivities and additional time is required to record images. The **Brightness** and **Contrast** Picture Control settings (□ 157) can not be adjusted while active D-Lighting is in effect.

### ✓ “Active D-Lighting” versus “D-Lighting”

The **Active D-Lighting** option in the shooting menu adjusts exposure before shooting to optimize the dynamic range, while the **D-Lighting** option in the retouch menu optimizes dynamic range in images after shooting.

### ✎ See Also

When **ADL bracketing** is selected for Custom Setting e5 (**Auto bracketing set**, □ 289), the camera varies Active D-Lighting over a series of shots. See page 129 for more information.

# Color Space

The color space determines the gamut of colors available for color reproduction. Choose a color space according to how photographs will be processed on leaving the camera.

Option	Description
sRGB <b>sRGB</b>	Choose for photographs that will be printed or used “as is,” with no further modification.
Adobe <b>Adobe RGB</b>	This color space is capable of expressing a wider gamut of colors than sRGB, making it the preferred choice for images that will be extensively processed or retouched.

## 1 Select Color space.

To display the menus, press the **MENU** button. Highlight **Color space** in the shooting menu and press **▶**.

MENU button

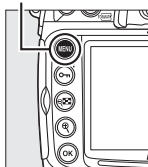

## 2 Select a color space.

Highlight the desired option and press **OK**.



## **Color Space**

Color spaces define the correspondence between colors and the numeric values that represent them in a digital image file. The sRGB color space is widely used, while the Adobe RGB color space is typically used in publishing and commercial printing. sRGB is recommended when taking photographs that will be printed without modification or viewed in applications that do not support color management, or when taking photographs that will be printed with ExifPrint, the direct printing option on some household printers, or kiosk printing or other commercial print services. Adobe RGB photographs can also be printed using these options, but colors will not be as vivid.

JPEG photographs taken in the Adobe RGB color space are Exif 2.21 and DCF 2.0 compliant; applications and printers that support Exif 2.21 and DCF 2.0 will select the correct color space automatically. If the application or device does not support Exif 2.21 and DCF 2.0, select the appropriate color space manually. An ICC color profile is embedded in TIFF photographs taken in the Adobe RGB color space, allowing applications that support color management to automatically select the correct color space. For more information, see the documentation provided with the application or device.

## **Nikon Software**

ViewNX (supplied) and Capture NX 2 (available separately) automatically select the correct color space when opening photographs created with the D300S.







# Flash Photography

## – *Using the Built-in Flash*

This chapter describes how to use the built-in flash.

<b>The Built-in Flash .....</b>	<b>170</b>
<b>Using the Built-in Flash .....</b>	<b>171</b>
<b>Flash Modes.....</b>	<b>175</b>
<b>Flash Compensation .....</b>	<b>177</b>
<b>FV Lock .....</b>	<b>178</b>



# The Built-in Flash

The built-in flash has a Guide Number (GN) 17/56 (m/ft., ISO 200, 20 °C/68 °F). It supports i-TTL balanced fill-flash for digital SLR, which uses monitor pre-flashes to adjust flash output for balanced lighting not only when natural lighting is inadequate but when filling in shadows and backlit subjects or adding a catch light to the subject's eyes. The following types of i-TTL flash control are supported:

---

**i-TTL balanced fill-flash for digital SLR:** Flash emits series of nearly invisible preflashes (monitor preflashes) immediately before main flash. Preflashes reflected from objects in all areas of frame are picked up by 1,005-pixel RGB sensor and are analyzed in combination with range information from matrix metering system to adjust flash output for natural balance between main subject and ambient background lighting. If type G or D lens is used, distance information is included when calculating flash output. Precision of calculation can be increased for non-CPU lenses by providing lens data (focal length and maximum aperture; see □ 195). Not available when spot metering is used.

---

**Standard i-TTL flash for digital SLR:** Flash output adjusted to bring lighting in frame to standard level; brightness of background is not taken into account. Recommended for shots in which main subject is emphasized at expense of background details, or when exposure compensation is used. Standard i-TTL flash for digital SLR is activated automatically when spot metering is selected.

---



## ISO Sensitivity

i-TTL flash control can be used at ISO sensitivities between 200 and 3200. At values over 3200 or under 200, the desired results may not be achieved at some ranges or aperture settings.



# Using the Built-in Flash

Follow these steps when using the built-in flash.

## 1 Choose a metering method (📖 102).

Select matrix or center-weighted metering to activate i-TTL balanced fill-flash for digital SLR. Standard i-TTL flash for digital SLR is activated automatically when spot metering is selected.

Metering selector

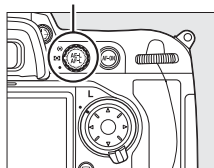

## 2 Press the flash pop-up button.

The built-in flash will pop up and begin charging. When the flash is fully charged, the flash-ready indicator (⚡) will light.

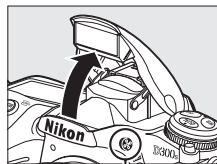

Flash pop-up button



## 3 Choose a flash mode.

Press the ⚡ button and rotate the main command dial until the desired flash mode icon is displayed in the control panel (📖 175).

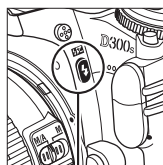

⚡ button

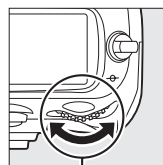

Main command dial

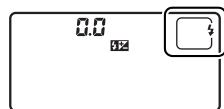

Control panel



## 4 Check exposure (shutter speed and aperture).

Press the shutter-release button halfway and check shutter speed and aperture. The settings available when the built-in flash is raised are listed below.

Mode	Shutter speed	Aperture	See page
<b>P</b>	Set automatically by camera ( $1/250$ s– $1/60$ s) <sup>1,2</sup>	Set automatically by camera	106
<b>S</b>	Value selected by user ( $1/250$ s–30 s) <sup>2</sup>		108
<b>A</b>	Set automatically by camera ( $1/250$ s– $1/60$ s) <sup>1,2</sup>	Value selected by user <sup>3</sup>	109
<b>M</b>	Value selected by user ( $1/250$ s–30 s, <b>b</b> , <b>L</b> , <b>b</b> ) <sup>2</sup>		111

- 1 Shutter speed may be set as slow as 30s in slow sync, slow rear-curtain sync, and slow sync with red-eye reduction flash modes.
- 2 Speeds as fast as  $1/8,000$  s are available with optional SB-900, SB-800, and SB-600 flash units when **1/320 s (Auto FP)** or **1/250 s (Auto FP)** is selected for Custom Setting e1 (**Flash sync speed**, □ 281).
- 3 Flash range varies with aperture and ISO sensitivity. Consult table of flash ranges (□ 174) when setting aperture in **A** and **M** modes.

The effects of the flash can be previewed by pressing the depth-of-field preview button to emit a modeling preflash (□ 289).

## 5 Take the picture.

Compose the photograph, focus, and shoot. If the flash-ready indicator (⚡) blinks for about three seconds after the photograph is taken, the flash has fired at full output and the photograph may be underexposed. Check the results in the monitor. If the photograph is underexposed, adjust settings and try again.

### See Also

See page 282 for information on **1/320 s (Auto FP)**.

## Lowering the Built-in Flash

To save power when the flash is not in use, press it gently downward until the latch clicks into place.

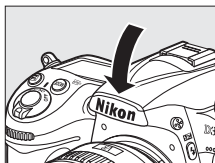

### **The Built-in Flash**

Use with lenses with focal lengths of 16–300 mm (☐ 344). Remove lens hoods to prevent shadows. The flash has a minimum range of 60 cm (2 ft.) and can not be used in the macro range of macro zoom lenses.

If the flash fires in continuous release mode (☐ 88), only one picture will be taken each time the shutter-release button is pressed.

The shutter release may be briefly disabled to protect the flash after it has been used for several consecutive shots. The flash can be used again after a short pause.

### **See Also**

See page 178 for information on locking flash value (FV) for a metered subject before recomposing a photograph.

For information on choosing a flash sync speed, see Custom Setting e1 (**Flash sync speed**, ☐ 281). For information on choosing the slowest shutter speed available when using the flash, see Custom Setting e2 (**Flash shutter speed**, ☐ 282). For information on flash control and using the built-in flash in commander mode, see Custom Setting e3 (**Flash cntrl for built-in flash**, ☐ 283).

See page 347 for information on using optional flash units. For information on the range of the built-in flash, see page 174.



## Aperture, Sensitivity, and Flash Range

The range of the built-in flash varies with sensitivity (ISO equivalency) and aperture.

Aperture at ISO equivalent of					Range	
200	400	800	1600	3200	m	ft.
1.4	2	2.8	4	5.6	1.0–12.0	3ft. 3in.–39ft. 4in.
2	2.8	4	5.6	8	0.7–8.5	2ft. 4in.–27ft. 11in.
2.8	4	5.6	8	11	0.6–6.1	2ft.–20ft.
4	5.6	8	11	16	0.6–4.2	2ft.–13ft. 9in.
5.6	8	11	16	22	0.6–3.0	2ft.–9ft. 10in.
8	11	16	22	32	0.6–2.1	2ft.–6ft. 11in.
11	16	22	32	—	0.6–1.5	2ft.–4ft. 11in.
16	22	32	—	—	0.6–1.1	2ft.–3ft. 7in.
22	32	—	—	—	0.6–0.8	2ft.–2ft. 7in.

The built-in flash has a minimum range of 0.6 m (2 ft.).

In programmed auto exposure mode (mode *P*), the maximum aperture (minimum f-number) is limited according to ISO sensitivity, as shown below:







Maximum aperture at ISO equivalent of:				
200	400	800	1600	3200
3.5	4	5	5.6	7.1

For each one-step increase in sensitivity (e.g., from 200 to 400), aperture is stopped down by half an f-stop. If the maximum aperture of the lens is smaller than given above, the maximum value for aperture will be the maximum aperture of the lens.



# Flash Modes

The D300S supports the following flash modes:

Flash mode	Description
 Front-curtain sync	This mode is recommended for most situations. In programmed auto and aperture-priority auto modes, shutter speed will automatically be set to values between $1/250$ and $1/60$ s ( $1/8,000$ to $1/60$ s when an optional flash unit is used with Auto FP High-Speed Sync; □ 281).
 Red-eye reduction	Red-eye reduction lamp lights for approximately one second before main flash. Pupils in subject's eyes contract, reducing "red-eye" effect sometimes caused by flash. Owing to one-second shutter-release delay, this mode is not recommended with moving subjects or in other situations in which quick shutter response is required. Avoid moving camera while red-eye reduction lamp is lit.
 Red-eye reduction with slow sync	Combines red-eye reduction with slow sync. Use for portraits taken against a backdrop of night scenery. Available only in programmed auto and aperture-priority auto exposure modes. Use of a tripod is recommended to prevent blurring caused by camera shake.
 Slow sync	Flash is combined with shutter speeds as slow as 30 s to capture both subject and background at night or under dim light. This mode is only available in programmed auto and aperture-priority auto exposure modes. Use of tripod is recommended to prevent blurring caused by camera shake.
 Rear-curtain sync	In shutter-priority auto or manual exposure mode, flash fires just before the shutter closes. Use to create effect of a stream of light behind moving objects. In programmed auto and aperture-priority auto, slow rear-curtain sync is used to capture both subject and background. Use of tripod is recommended to prevent blurring caused by camera shake. 

## Flash Control Mode

The information display shows the flash control mode for the built-in flash (**Built-in**) and for optional flash units attached to the camera accessory shoe (**Optional**) as follows:

	i-TTL		Auto aperture (AA) <sup>1/</sup> non-TTL auto flash (A)		Manual	
	Built-in	Optional	Built-in	Optional	Built-in	Optional
TTL <sup>2</sup>			—			
Auto FP (□ 281)	—		—		—	
Repeating flash <sup>2</sup>	—	—	—	—		
Commander mode <sup>2</sup>			—			

1 Available with SB-900 and SB-800 only.

2 Flash control mode for built-in flash can be selected using Custom Setting e3 (**Flash cntrl for built-in flash**, □ 283).

## See Also

See Custom Setting e1 (**Flash sync speed**, □ 281) for information on flash sync speeds as fast as  $1/320$  s.



# Flash Compensation

Flash compensation is used to alter flash output by from  $-3\text{EV}$  to  $+1\text{EV}$  in increments of  $1/3\text{EV}$ , changing the brightness of the main subject relative to the background. Flash output can be increased to make the main subject appear brighter, or reduced to prevent unwanted highlights or reflections.

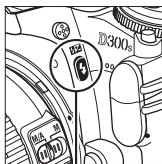

Press the  button and rotate the sub-command dial until the desired value is displayed in the control panel. In general, choose positive values to make the main subject brighter, negative values to make it darker.

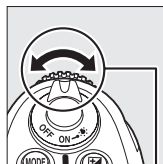

 button



Sub-command dial

At values other than  $\pm 0.0$ , a  icon will be displayed in the control panel and viewfinder after you release the  button. The current value for flash compensation can be confirmed by pressing the  button.

Normal flash output can be restored by setting flash compensation to  $\pm 0.0$ . Flash compensation is not reset when the camera is turned off.

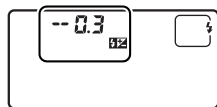

$\pm 0\text{EV}$

( button pressed)



$-0.3\text{EV}$



$+1.0\text{EV}$

## Optional Flash Units

Flash compensation is also available with optional SB-900, SB-800, SB-600, SB-400, and SB-R200 flash units. The SB-900, SB-800, and SB-600 also allow flash compensation to be set using the controls on the flash unit.

## See Also

For information on choosing the size of the increments available when setting flash compensation, see Custom Setting b3 (**Exp comp/fine tune**,  270).

# FV Lock

This feature is used to lock flash output, allowing photographs to be recomposed without changing the flash level and ensuring that flash output is appropriate to the subject even when the subject is not positioned in the center of the frame. Flash output is adjusted automatically for any changes in ISO sensitivity and aperture.

To use FV lock:

## 1 Assign FV lock to the Fn button.

Select **FV lock** for Custom Setting f5  
(**Assign Fn button** > **Fn button press**,  
📖 292).



## 2 Press the flash pop-up button.

The built-in flash will pop up and begin charging.

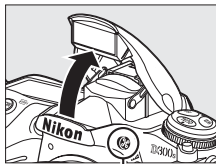

Flash pop-up  
button

## 3 Focus.

Position the subject in the center of the frame and press the shutter-release button halfway to focus.





## 4 Lock flash level.

After confirming that the flash ready indicator (⚡) is displayed in the viewfinder, press the **Fn** button. The flash will emit a monitor preflash to determine the appropriate flash level. Flash output will be locked at this level and FV lock icons (🔒) will appear in the control panel and viewfinder.

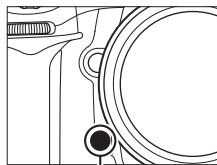

**Fn button**

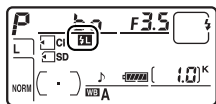

## 5 Recompose the photograph.



## 6 Take the photograph.

Press the shutter-release button the rest of the way down to shoot. If desired, additional pictures can be taken without releasing FV lock.

## 7 Release FV lock.

Press the **Fn** button to release FV lock. Confirm that the FV lock icons (🔒) are no longer displayed in the control panel and viewfinder.

### ✓ Using FV Lock with the Built-in Flash

FV lock is only available with the built-in flash when **TTL** is selected for Custom Setting e3 (**Flash cntrl for built-in flash**, 📖 283).



### Using FV Lock with Optional Flash Units

FV lock is also available with SB-900, SB-800, SB-600, SB-400, and SB-R200 flash units (available separately). Set the optional flash to TTL mode (the SB-900 and SB-800 can also be used in AA mode; see the flash manual for details). While FV lock is in effect, flash output will automatically be adjusted for changes in flash zoom head position.



When Commander mode is selected for Custom Setting e3 (**Flash ctrl for built-in flash**,  283), FV lock can be used with remote SB-900, SB-800, SB-600, or SB-R200 flash units if (a) any of the built-in flash, flash group A, or flash group B is in TTL mode, or (b) a flash group is composed entirely of SB-900 and SB-800 flash units in TTL or AA mode.

### Metering

The metering areas for FV lock when using optional flash unit are as follows:

Flash unit	Flash mode	Metered area
Stand-alone flash unit	i-TTL	4-mm circle in center of frame
	AA	Area metered by flash exposure meter
Used with other flash units (Advanced Wireless Lighting)	i-TTL	Entire frame
	AA	Area metered by flash exposure meter
	A (master flash)	

### See Also

For information on using the depth-of-field preview or **AE-L/AF-L** button for FV lock, see Custom Setting f6 (**Assign preview button**,  296) or Custom Setting f7 (**Assign AE-L/AF-L button**,  296).





# Other Shooting Options

This chapter covers restoring default settings, making multiple exposures, interval timer photography, and using GPS units and non-CPU lenses.

<b>Two-Button Reset: Restoring Default Settings .....</b>	<b>182</b>
<b>Multiple Exposure .....</b>	<b>184</b>
<b>Interval Timer Photography .....</b>	<b>189</b>
<b>Non-CPU Lenses .....</b>	<b>195</b>
<b>Using a GPS Unit .....</b>	<b>198</b>



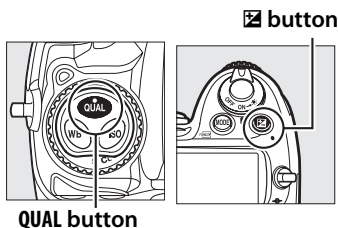

# Two-Button Reset: Restoring Default Settings

The camera settings listed below can be restored to default values by holding the **QUAL** and  buttons down together for more than two seconds (these buttons are marked by a green dot). The control panel turns off briefly while settings are reset.



Option	Default
Focus point	Center
Exposure mode	Programmed auto
Flexible program	Off
Exposure compensation	Off
AE hold	Off <sup>1</sup>

Option	Default
Bracketing	Off <sup>2</sup>
Flash mode	Front-curtain sync
Flash compensation	Off
FV lock	Off
Multiple exposure	Off

- 1 Custom Setting f7 (**Assign AE-L/AF-L button**,  296) is unaffected.
- 2 Number of shots is reset to zero. Bracketing increment is reset to 1EV (exposure/flash bracketing) or 1 (white balance bracketing).  AUTO Auto is selected for the second shot of two-shot ADL bracketing programs.



The following shooting-menu options will also be reset. Only settings in the bank currently selected using the **Shooting menu bank** option will be reset (□ 254). Settings in the remaining banks are unaffected.

Option	Default	Option	Default
Image quality	JPEG Normal	White balance	Auto*
Image size	Large	ISO sensitivity	200

\* Fine-tuning off.

If the current Picture Control has been modified, existing settings for the Picture Control will also be restored.



 **See Also**

See page 368 for a list of default settings.

# Multiple Exposure

Follow the steps below to record a series of two to ten exposures in a single photograph. Multiple exposures can be recorded at any image quality setting, and produce results with colors noticeably better than photographs combined in an imaging application because they make use of RAW data from the camera image sensor.

## ■ Creating a Multiple Exposure

Note that at default settings, shooting will end and a multiple exposure will be recorded automatically if no operations are performed for 30 s.

### Extended Recording Times

For an interval between exposures of more than 30 s, select **On** for the **Image review** (251) option in the playback menu and extend the monitor-off delay using Custom Setting c4 (**Monitor off delay**, 274). The maximum interval between exposures is 30 s longer than the option selected for Custom Setting c4.

## 1 Select Multiple exposure.

Press the **MENU** button to display the menus. Highlight **Multiple exposure** in the shooting menu and press **▶**.

MENU button

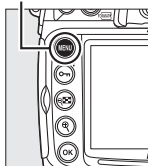

## 2 Select Number of shots.

Highlight **Number of shots** and press **▶**.

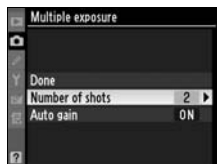

### 3 Select the number of shots.

Press ▲ or ▼ to choose the number of exposures that will be combined to form a single photograph and press **OK**.

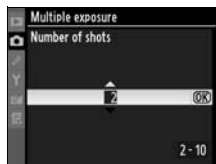

### 4 Select Auto gain.

Highlight **Auto gain** and press ►.



### 5 Set gain.

Highlight one of the following options and press **OK**.

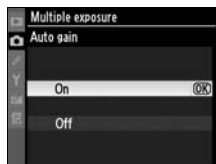

Option	Description
<b>On</b>	Gain adjusted according to number of exposures actually recorded (gain for each exposure is set to $\frac{1}{2}$ for 2 exposures, $\frac{1}{3}$ for 3 exposures, etc.).
<b>Off</b>	Gain is not adjusted when recording multiple exposure. Recommended if background is dark.



## 6 Select Done.

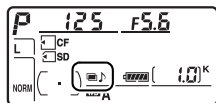
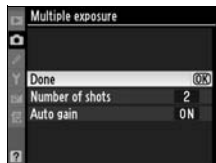

Highlight **Done** and press **OK**. A  icon will be displayed in the control panel. To exit without taking a multiple exposure, select **Multiple exposure** > **Reset** in the shooting menu.



## 7 Frame a photograph, focus, and shoot.

In continuous high-speed and continuous low-speed release modes (86), the camera records all exposures in a single burst. In other release modes, one photograph will be taken each time the shutter-release button is pressed; continue shooting until all exposures have been recorded (for information on interrupting a multiple exposure before all photographs are recorded, see page 188).



The  icon will blink until shooting ends. When shooting ends, multiple exposure mode will end and the  icon will no longer be displayed. Repeat steps 1–7 to take additional multiple exposures.

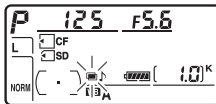



### **Multiple Exposure**

Do not remove or replace the memory card while recording a multiple exposure.

Live view (📷 47) can not be used to record multiple exposures.

The information listed in the playback photo information display (including date of recording and camera orientation) is for the first shot in the multiple exposure.

If no operations are performed for 30 s after the monitor has turned off during playback or menu operations, shooting will end and a multiple exposure will be created from the exposures that have been recorded to that point.

### **Interval Timer Photography**

If interval timer photography is activated before the first exposure is taken, the camera will record exposures at the selected interval until the number of exposures specified in the multiple exposure menu have been taken (the number of shots listed in the interval timer shooting menu is ignored). These exposures will then be recorded as a single photograph and multiple exposure mode and interval timer shooting will end. Cancelling multiple exposure cancels interval timer shooting.

### **Other Settings**

While multiple exposure mode is in effect, memory cards can not be formatted and the following can not be changed: bracketing and shooting menu options other than **White balance** and **Interval timer shooting** (note that **Interval timer shooting** can only be adjusted before the first exposure is taken). The **Lock mirror up for cleaning** and **Image Dust Off ref photo** options in the setup menu can not be used.



## ■ Interrupting Multiple Exposures

Selecting **Multiple exposure** in the shooting menu while a multiple exposure is being recorded displays the options shown at right.

To interrupt a multiple exposure before the specified number of exposures have been taken, highlight **Cancel** and press **OK**. If

shooting ends before the specified number of exposures have been taken, a multiple exposure will be created from the exposures that have been recorded to that point. If **Auto gain** is on, gain will be adjusted to reflect the number of exposures actually recorded. Note that shooting will end automatically if:

- A two-button reset is performed (📖 182)
- The camera is turned off
- The battery is exhausted
- Pictures are deleted

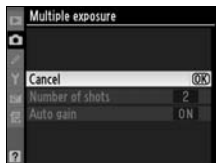

# Interval Timer Photography

The camera is equipped to take photographs automatically at preset intervals.

## ☑ Before Shooting

Select a release mode other than self-timer (⏱) or mirror-up (MUP) when using the interval timer. Before beginning interval timer photography, take a test shot at current settings and view the results in the monitor. Remember that the camera will focus before each shot—no shots will be taken if the camera is unable to focus in single-servo AF.

Before choosing a starting time, select **Time zone and date** in the setup menu and make sure that the camera clock is set to the correct time and date (📖 29).

Use of a tripod is recommended. Mount the camera on a tripod before shooting begins. To ensure that shooting is not interrupted, be sure the battery is fully charged.

## 1 Select Interval timer shooting.

Press the **MENU** button to display the menus. Highlight **Interval timer shooting** in the shooting menu and press **▶**.

MENU button

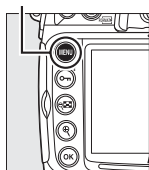

## 2 Select a starting trigger.

Highlight one of the following and press **▶**:

- To start shooting about 3 s after settings are completed, select **Now** and proceed to Step 4.
- To choose a starting time, select **Start time** and proceed to Step 3.

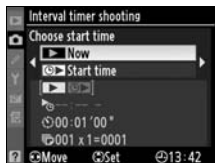

### 3 Choose a start time.

Press ◀ or ▶ to highlight hours or minutes; press ▲ or ▼ to change. The starting time is not displayed if **Now** is selected for **Choose start time**. Press ▶ to continue.

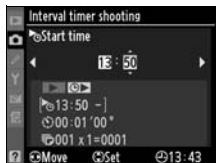

### 4 Choose an interval.

Press ◀ or ▶ to highlight hours, minutes, or seconds; press ▲ or ▼ to change. Choose an interval longer than the slowest anticipated shutter speed. Press ▶ to continue.

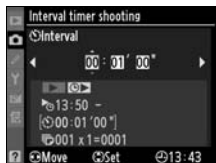

### 5 Choose the number of intervals and number of shots per interval.

Press ◀ or ▶ to highlight number of intervals or number of shots; press ▲ or ▼ to change. Press ▶ to continue.

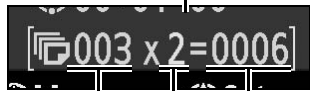
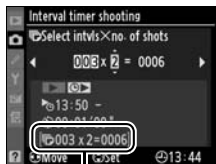

Number of intervals

Number of shots/  
interval

Total number of  
shots



## 6 Start shooting.

Highlight **Start** > **On** and press  $\odot$  (to return to the shooting menu without starting the interval timer, highlight **Start** > **Off** and press  $\odot$ ). The

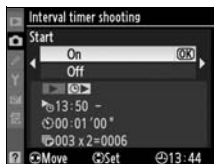

first series of shots will be taken at the specified starting time, or after about 3 s if **Now** was selected for **Choose start time** in Step 2. Shooting will continue at the selected interval until all shots have been taken. Note that because shutter speed and the time needed to record the image to the memory card may vary from shot to shot, the interval between a shot being recorded and the start of the next shot may vary. If shooting can not proceed at current settings (for example, if a shutter speed of  $\frac{1}{4}$  is currently selected in manual exposure mode or the start time is in less than a minute), a warning will be displayed in the monitor.

### Cover the Viewfinder

When taking photos without your eye to the viewfinder, remove the DK-23 rubber eyecup (1); you will need to hold the camera firmly) and cover the viewfinder with the supplied DK-5 eyepiece cap (2) to prevent light entering via the viewfinder from interfering with exposure.

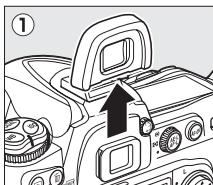

### DK-5 eyepiece cap

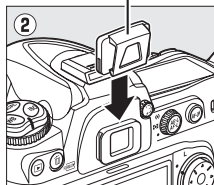

### Out of Memory

If the memory card is full, the interval timer will remain active but no pictures will be taken. Resume shooting (193) after deleting some pictures or turning the camera off and inserting another memory card.

## Bracketing

Adjust bracketing settings before starting interval timer photography. If exposure, flash, or ADL bracketing is active while interval timer photography is in effect, the camera will take the number of shots in the bracketing program at each interval, regardless of the number of shots specified in the interval timer menu. If white balance bracketing is active while interval timer photography is in effect, the camera will take one shot at each interval and process it to create the number of copies specified in the bracketing program.

## During Shooting

During interval timer photography, the **INTVL** icon in the control panel will blink. Immediately before the next shooting interval begins, the shutter speed display will show the number of intervals remaining, and the aperture display will show the number of shots remaining in the current interval. At other times, the number of intervals remaining and the number of shots in each interval can be viewed by pressing the shutter-release button halfway (once the button is released, the shutter speed and aperture will be displayed until the exposure meters turn off).

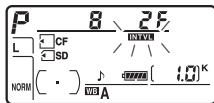

To view current interval timer settings, select **Interval timer shooting** between shots. While interval timer photography is in progress, the interval timer menu will show the starting time, the shooting interval, and the number of intervals and shots remaining. None of these items can be changed while interval timer photography is in progress.

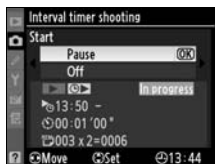

## ■ ■ Pausing Interval Timer Photography

Interval time photography can be paused by:

- Pressing the **OK** button between intervals
- Highlighting **Start > Pause** in the interval timer menu and pressing **OK**
- Turning the camera off and then on again (if desired, the memory card can be replaced while the camera is off)
- Selecting self-timer (☺) or mirror-up (**MUP**) release modes
- Pressing the **Lv** button

To resume shooting:

### 1 Choose a new starting trigger.

Choose a new starting trigger and start time as described on page 189.

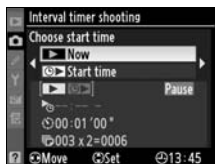

### 2 Resume shooting.

Highlight **Start > Restart** and press **OK**. Note that if interval timer photography was paused during shooting, any shots remaining in the current interval will be canceled.

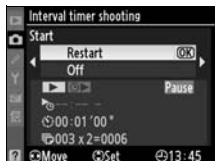

## ■ Interrupting Interval Timer Photography

Interval timer shooting will end automatically if the battery is exhausted. Interval timer photography can also be ended by:

- Selecting **Start > Off** in the interval timer menu
- Performing a two button reset (☐ 182)
- Selecting **Reset shooting menu** in the shooting menu (☐ 256)
- Changing bracketing settings (☐ 120)

Normal shooting will resume when interval timer photography ends.

## ■ No Photograph

Photographs will not be taken if the previous photograph has yet to be taken, the memory buffer or memory card is full, or the camera is unable to focus in single-servo AF (note that the camera focuses again before each shot).

### Release Mode

Regardless of the release mode selected, the camera will take the specified number of shots at each interval. In **C** (continuous high speed) mode, photographs will be taken at a rate of up to 7 shots per second. In **S** (single frame) and **L** (continuous low-speed) modes, photographs will be taken at the rate chosen for Custom Setting d5 (**CL mode shooting speed**, ☐ 276); in mode **Q**, camera noise will be reduced.

### Using the Monitor

Pictures can be played back and shooting and menu settings can be adjusted freely while interval timer photography is in progress. The monitor will turn off automatically about four seconds before each interval.

### Shooting Menu Banks

Changes to interval timer settings apply to all shooting menu banks (☐ 254). If shooting menu settings are reset using the **Reset shooting menu** item in the shooting menu (☐ 256), interval timer settings will be reset as follows:

- Choose start time: Now
- Interval: 00:01:00"
- Number of intervals: 1
- Number of shots: 1
- Start shooting: Off



# Non-CPU Lenses

By specifying lens data (lens focal length and maximum aperture), the user can gain access to a variety of CPU lens functions when using a non-CPU lens (☐ 342). If the focal length of the lens is known:

- Power zoom can be used with SB-900, SB-800, and SB-600 flash units (available separately)
- Lens focal length is listed (with an asterisk) in the playback photo info display

When the maximum aperture of the lens is known:

- The aperture value is displayed in the control panel and viewfinder
- Flash level is adjusted for changes in aperture
- Aperture is listed (with an asterisk) in the playback photo info display

Specifying both the focal length and maximum aperture of the lens:

- Enables color matrix metering (note that it may be necessary to use center-weighted or spot metering to achieve accurate results with some lenses, including Reflex-NIKKOR lenses)
- Improves the precision of center-weighted and spot metering and i-TTL balanced fill-flash for digital SLR

## Focal Length Not Listed

If the correct focal length is not listed, choose the closest value greater than the actual focal length of the lens.

## Zoom Lenses

Lens data are not adjusted when non-CPU lenses are zoomed in or out. After changing the zoom position, select new values for lens focal length and maximum aperture.



## ■ The Non-CPU Lens Data Menu

### 1 Select Non-CPU lens data.

Press the **MENU** button to display the menus. Highlight **Non-CPU lens data** in the setup menu and press **▶**.

MENU button

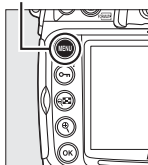

### 2 Select a lens number.

Highlight **Lens number** and press **◀** or **▶** to choose a lens number between 1 and 9.

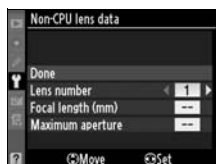

### 3 Select a focal length.

Highlight **Focal length (mm)** and press **◀** or **▶** to choose a focal length between 6 and 4,000 mm.

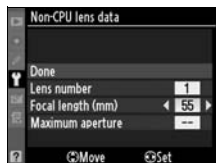

### 4 Select a maximum aperture.

Highlight **Maximum aperture** and press **◀** or **▶** to choose a maximum aperture between f/1.2 and f/22. The maximum aperture for teleconverters is the combined maximum aperture of the teleconverter and lens.

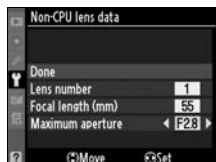

## 5 Select Done.

Highlight **Done** and press **OK**. The specified focal length and aperture will be stored under the chosen lens number. This combination of focal length and aperture can be recalled at any time by selecting the lens number using camera controls as described below.

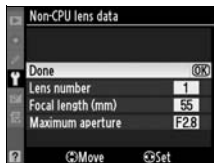

## Choosing a Lens Number Using Camera Controls

### 1 Assign non-CPU lens number selection to a camera control.

Select **Choose non-CPU lens number** as the “+command dials” option for a camera control in the Custom Settings menu. Non-CPU lens number selection can be assigned to the **Fn** button (Custom Setting f5, **Assign Fn button**, [□ 292](#)), the depth-of-field preview button (Custom Setting f6, **Assign preview button**, [□ 296](#)), or the **AE-L/AF-L** button (Custom Setting f7, **Assign AE-L/AF-L button**, [□ 296](#)).

### 2 Use the selected control to choose a lens number.

Press the selected button and rotate the main command dial until the desired lens number is displayed in the control panel.

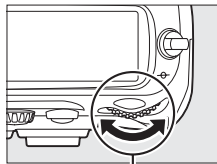

Main command dial

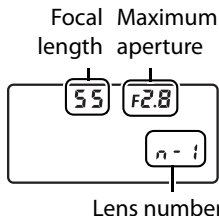

# Using a GPS Unit

A GPS unit can be connected to the ten-pin remote terminal, allowing the current latitude, longitude, altitude, Coordinated Universal Time (UTC), and heading to be recorded with each photograph taken. The camera can be used with an optional GP-1 GPS unit (see below; note that the GP-1 does not provide the compass heading), or with third-party units connected via an optional MC-35 GPS adapter cord (☐ 199).

## ■ ■ *The GP-1 GPS Unit*

The GP-1 is an optional GPS unit designed for use with Nikon digital cameras. For information on connecting the unit, see the manual provided with the GP-1.

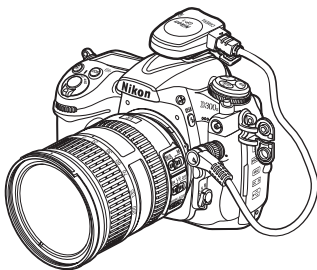



## ■ ■ Other GPS Units

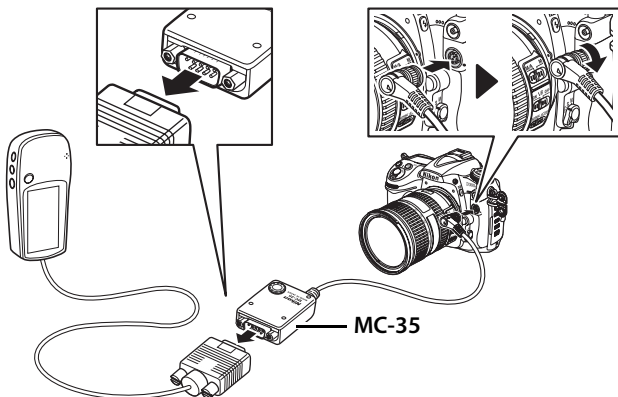





Optional Garmin GPS units that conform to version 2.01 or 3.01 of the National Marine Electronics Association NMEA0183 data format can be connected to the camera's ten-pin remote terminal using an MC-35 GPS adapter cord (available separately; □ 356). Operation has been confirmed with Garmin eTrex and Garmin geko series devices equipped with a PC interface cable connector. These devices connect to the MC-35 using a cable with a D-sub 9-pin connector provided by the manufacturer of the GPS device. See the MC-35 instruction manual for details. Before turning the camera on, set the GPS device to NMEA mode (4800 baud).

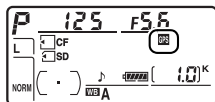

## ■ ■ The GPS Icon

When the camera establishes communication with a GPS device, a  icon will be displayed in the control panel. Photo information for pictures taken while the 



icon is displayed will include a page of GPS data ( 214). GPS data are only recorded when the  icon is displayed; confirm that the  icon is displayed in the control panel before shooting (a flashing  icon indicates that the GPS device is searching for a signal; pictures taken while the  icon is flashing will not include GPS data). If no data are received from the GPS unit for two seconds, the  icon will clear from the display and the camera will stop recording GPS information.



## ■ ■ Setup Menu Options

The **GPS** item in the setup menu contains the options listed below.

- **Auto meter off:** Choose whether or not the exposure meters will turn off automatically when a GPS unit is attached.

Option	Description
<b>Enable</b>	Exposure meters will turn off automatically if no operations are performed for the period specified in Custom Setting c2 ( <b>Auto meter-off delay</b> ). This reduces the drain on the battery but may prevent GPS data from being recorded if the shutter-release button is pressed all the way down without pausing.
<b>Disable</b>	Exposure meters will not turn off while a GPS unit is connected; GPS data will always be recorded.

- **Position:** This item is only available if a GPS device is connected, when it displays the current latitude, longitude, altitude, Coordinated Universal Time (UTC), and heading (if supported) as reported by the GPS device.

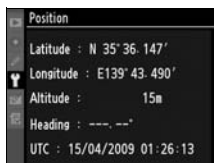

### **Heading**

The heading is only recorded if the GPS device is equipped with a digital compass (note that the GP-1 is not equipped with a compass). Keep the GPS device pointing in the same direction as the lens and at least 20cm (8 in.) from the camera.

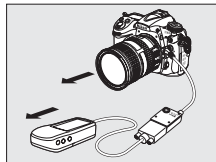

### **Coordinated Universal Time (UTC)**

UTC data is provided by the GPS device and is independent of the camera clock.







# More About Playback

## – *Playback Options*

This chapter describes how to play back photographs and details the operations that can be performed during playback.

<b>Full-Frame Playback.....</b>	<b>204</b>
<b>Photo Information .....</b>	<b>207</b>
<b>Viewing Multiple Images: Thumbnail Playback .....</b>	<b>216</b>
<b>Taking a Closer Look: Playback Zoom .....</b>	<b>218</b>
<b>Protecting Photographs from Deletion .....</b>	<b>219</b>
<b>Deleting Photographs.....</b>	<b>220</b>



# Full-Frame Playback

To play photographs back, press the  button. The most recent photograph will be displayed in the monitor.

 button

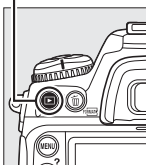

 button

 button

MENU button

 button

 button

 button

 button

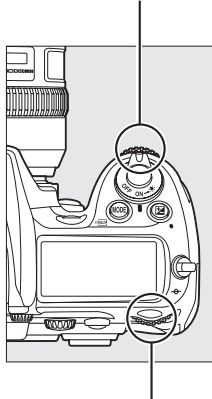
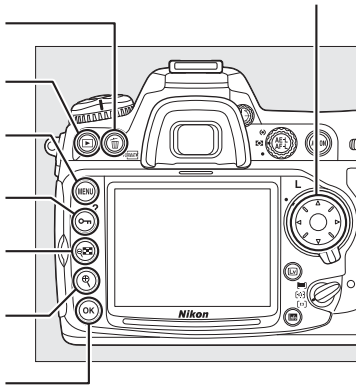

Multi selector

Sub-command dial











Main command dial

## Rotate Tall

To display “tall” (portrait-orientation) photographs in tall orientation, select **On** for the **Rotate tall** option in the playback menu ( 251). Note that because the camera itself is already in the appropriate orientation during shooting, images are not rotated automatically during image review ( 206).

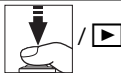

To	Use	Description
View additional photographs		Press ► to view photographs in order recorded, ◀ to view photographs in reverse order.
View photo information		Press ▲ or ▼ to view information about current photograph (☞ 207).
View thumbnails		See page 216 for more information on the thumbnail display.
Zoom in on photograph		See page 218 for more information on playback zoom.
Delete images		Confirmation dialog will be displayed. Press ☒ again to delete photo.
Change protect status		To protect image, or to remove protection from protected image, press 🔑 button (☞ 219).
Return to shooting mode		Monitor will turn off. Photographs can be taken immediately.
Display menus	<b>MENU</b>	See page 243 for more information.
Retouch picture		Create retouched copy of current photograph or movie (☞ 64, 315).
Play movie		If current picture is marked with 🎬 icon to show that it is a movie, pressing center of multi selector starts movie playback (☞ 63).



### **Image Review**

When **On** is selected for **Image review** in the playback menu (☰ 251), photographs are automatically displayed in the monitor for about 4 s after shooting (because the camera is already in the correct orientation, images are not rotated automatically during image review). In single-frame, quiet shutter-release, self-timer, and mirror-up release modes, photographs are displayed one at a time as they are taken. In continuous release mode, display begins when shooting ends, with the first photograph in the current series displayed.

### **See Also**

For information on choosing how long the monitor will remain on when no operations are performed, see Custom Setting c4 (**Monitor off delay**, ☰ 274).

The roles of the multi selector buttons can be reversed, so that the ▲ and ▼ buttons display other images and the ◀ and ▶ buttons control photo information. See Custom Setting f4 (**Photo info/playback**, ☰ 292) for details.



# Photo Information

Photo information is superimposed on images displayed in full-frame playback. There are up to 9 pages of information for each photo. Press ▲ or ▼ to cycle through photo information as shown below. Note that shooting data, RGB histograms, and highlights are only displayed if corresponding option is selected for **Display mode** (☞ 247; shooting data page 4 is only displayed if copyright information was recorded with the photograph as described on page 309). GPS data are only displayed if a GPS device was used when the photo was taken.

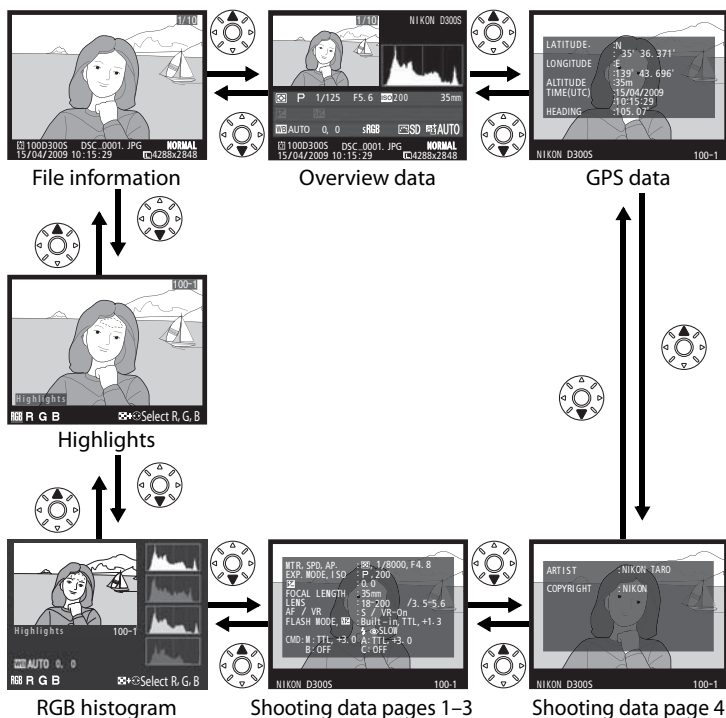

## File Information

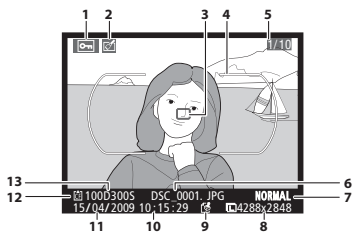

1	Protect status .....	219
2	Retouch indicator .....	315
3	Focus point <sup>1,2</sup> .....	78
4	AF area brackets <sup>1</sup> .....	36, 52
5	Frame number/total number of frames	
6	File name .....	258
7	Image quality .....	68
8	Image size .....	71
9	Image authentication .....	308
10	Time of recording .....	29
11	Date of recording .....	29
12	Current card slot .....	72
13	Folder name .....	256

- 1 Displayed only if **Focus point** is selected for **Display mode** (□ 247).
- 2 If photograph was taken in focus mode **S**, display shows point where focus first locked. In focus mode **C**, focus point is only displayed if single-point or dynamic area was selected for AF-area mode and camera was able to focus.



## Highlights<sup>1</sup>

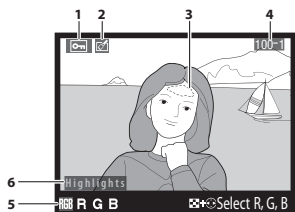

- 1 Protect status ..... 219
- 2 Retouch indicator ..... 315
- 3 Image highlights<sup>2</sup>
- 4 Folder number-frame number ..... 256
- 5 Current channel<sup>2</sup>
- 6 Highlight display indicator

- 1 Displayed only if **Highlights** is selected for **Display mode** (□ 247).
- 2 Blinking areas indicate highlights (areas that may be overexposed) for current channel. Press ◀ or ▶ while pressing  button as follows:

 button

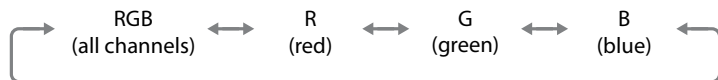
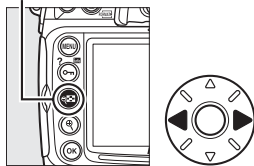

# RGB Histogram<sup>1</sup>

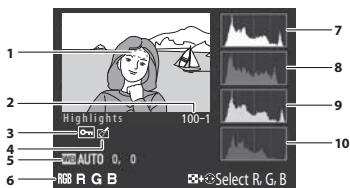

<b>1</b>	Image highlights <sup>2</sup> .....	209
<b>2</b>	Folder number–frame number .....	256
<b>3</b>	Protect status .....	219
<b>4</b>	Retouch indicator .....	315
<b>5</b>	White balance .....	133
	Color temperature .....	141
	White balance fine-tuning .....	137
	Preset manual .....	142
<b>6</b>	Current channel <sup>2</sup>	
<b>7</b>	Histogram (RGB channel) <sup>3</sup> . In all histograms, horizontal axis gives pixel brightness, vertical axis number of pixels.	
<b>8</b>	Histogram (red channel) <sup>3</sup>	
<b>9</b>	Histogram (green channel) <sup>3</sup>	
<b>10</b>	Histogram (blue channel) <sup>3</sup>	

- 1 Displayed only if **RGB histogram** is selected for **Display mode** (☐ 247).
- 2 Blinking areas indicate highlights (areas that may be overexposed) for current channel. Press ◀ or ▶ while pressing  button to cycle through channels as follows:

 **button**

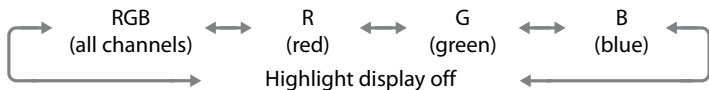
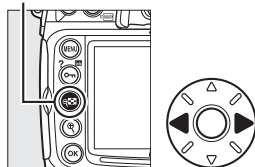



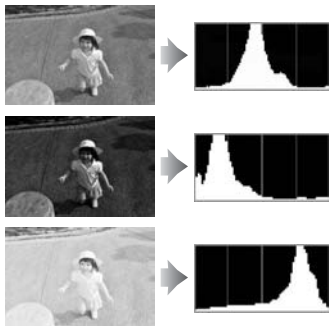

3 Some sample histograms are shown below:

- If the image contains objects with a wide range of brightnesses, the distribution of tones will be relatively even.
- If the image is dark, tone distribution will be shifted to the left.
- If the image is bright, tone distribution will be shifted to the right.



Increasing exposure compensation shifts the distribution of tones to the right, while decreasing exposure compensation shifts the distribution to the left. Histograms can provide a rough idea of overall exposure when bright ambient lighting makes it difficult to see photographs in the monitor.

### Playback Zoom

To zoom in on the photograph when the histogram is displayed, press . Use the  and  buttons to zoom in and out and scroll the image with the multi selector. The histogram will be updated to show only the data for the portion of the image visible in the monitor.



### Histograms

Camera histograms are intended as a guide only and may differ from those displayed in imaging applications.



# Shooting Data Page 1<sup>1</sup>

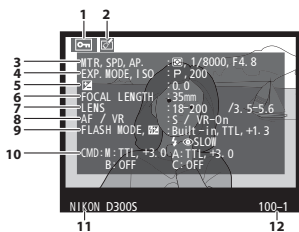

1	Protect status	219
2	Retouch indicator	315
3	Metering method	102
	Shutter speed	108, 111
	Aperture	109, 111

4	Exposure mode	104
	ISO sensitivity <sup>2</sup>	96
5	Exposure compensation	118
	Optimal exposure tuning <sup>3</sup>	272
6	Focal length	195, 346
7	Lens data	195
8	Focus mode	74
	Lens VR (vibration reduction) <sup>4</sup>	26
9	Flash mode	171
	Flash compensation	177
10	Commander mode/group name/flash control mode/flash compensation	285
11	Camera name	
12	Folder number–frame number	256

- 1 Displayed only if **Data** is selected for **Display mode** (□ 247).
- 2 Displayed in red if photo was taken with ISO sensitivity auto control on.
- 3 Displayed if Custom Setting b6 (**Fine tune optimal exposure**, □ 272) has been set to a value other than zero for any metering method.
- 4 Displayed only if VR lens is attached.



## Shooting Data Page 2<sup>1</sup>

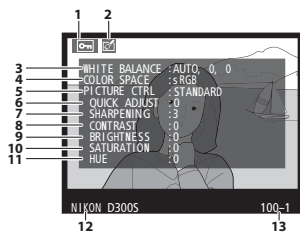

1	Protect status .....	219
2	Retouch indicator .....	315
3	White balance .....	133
	Color temperature .....	141
	White balance fine-tuning .....	137
	Preset manual .....	142
4	Color space .....	166
5	Picture Control .....	154
6	Quick adjust <sup>2</sup> .....	157
	Original Picture Control <sup>3</sup> .....	154
7	Sharpening .....	157
8	Contrast .....	157
9	Brightness .....	157
10	Saturation <sup>4</sup> .....	157
	Filter effects <sup>5</sup> .....	157
11	Hue <sup>4</sup> .....	157
	Toning <sup>5</sup> .....	157
12	Camera name .....	
13	Folder number–frame number .....	256

- 1 Displayed only if **Data** is selected for **Display mode** (□ 247).
- 2 **Standard** and **Vivid** Picture Controls only.
- 3 **Neutral**, **Monochrome**, and custom Picture Controls.
- 4 Not displayed with monochrome Picture Controls.
- 5 Monochrome Picture Controls only.

## Shooting Data Page 3\*

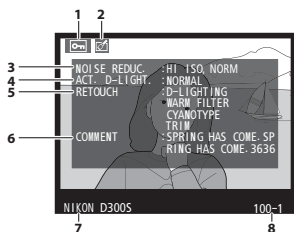

1	Protect status .....	219
2	Retouch indicator .....	315
3	High ISO noise reduction .....	259
	Long exposure noise reduction .....	258
4	Active D-Lighting .....	164
5	Retouch history .....	315
6	Image comment .....	303
7	Camera name .....	
8	Folder number–frame number .....	256

- \* Displayed only if **Data** is selected for **Display mode** (□ 247).



## Shooting Data Page 4\*

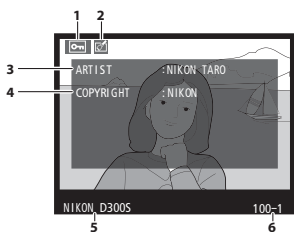

1	Protect status .....	219
2	Retouch indicator .....	315
3	Name of photographer .....	309
4	Copyright holder .....	309
5	Camera name	
6	Folder number–frame number .....	256

\* Displayed only if **Data** is selected for **Display mode** (☐ 247) and copyright information was appended to photograph (☐ 309).

## GPS Data<sup>1</sup>

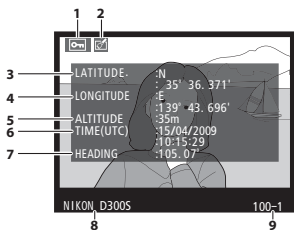

1	Protect status .....	219
2	Retouch indicator .....	315
3	Latitude	
4	Longitude	
5	Altitude	
6	Coordinated Universal Time (UTC)	
7	Heading <sup>2</sup>	
8	Camera name	
9	Folder number–frame number .....	256

- 1 Displayed only if GPS device was used when photo was taken (☐ 198).
- 2 Displayed only if GPS device is equipped with electronic compass.



## Overview Data

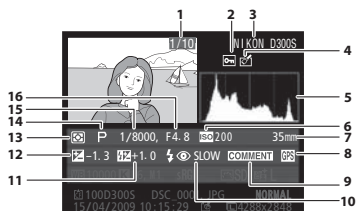

1	Frame number/total number of frames
2	Protect status ..... 219
3	Camera name
4	Retouch indicator..... 315

5	Histogram showing the distribution of tones in the image (☐ 211). Horizontal axis corresponds to pixel brightness, vertical axis shows number of pixels of each brightness in image.
6	ISO sensitivity * ..... 96
7	Focal length..... 195, 346
8	GPS data indicator ..... 198
9	Image comment indicator ..... 303
10	Flash mode ..... 171
11	Flash compensation ..... 177
12	Exposure compensation ..... 118
13	Metering method ..... 102
14	Exposure mode..... 104
15	Shutter speed ..... 108, 111
16	Aperture ..... 109, 111

\* Displayed in red if photo was taken with ISO sensitivity auto control on.

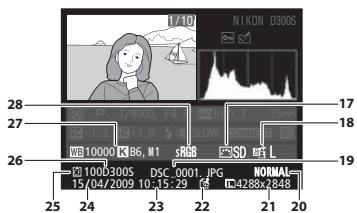

17	Picture Control * ..... 154
18	Active D-Lighting ..... 165
19	File name ..... 258

20	Image quality..... 68
21	Image size ..... 71
22	Image authentication indicator ..... 308
23	Time of recording..... 29
24	Date of recording..... 29
25	Current card slot ..... 72
26	Folder number ..... 256
27	White balance ..... 133
	Color temperature ..... 141
	White balance fine-tuning ..... 137
	Preset manual ..... 142
28	Color space ..... 166







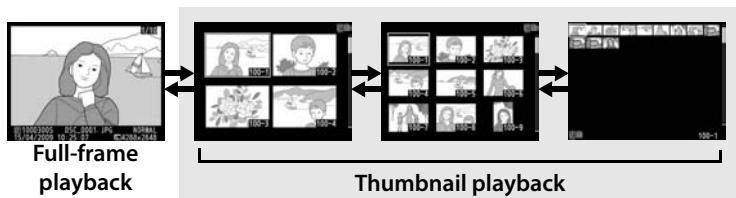





\* -- is displayed if photo was taken using optional Picture Control (☐ 155) that is no longer stored in camera.

# Viewing Multiple Images: Thumbnail Playback



To display images in “contact sheets” of four, nine, or 72 images, press the  button.



The following operations can be performed:

To	Use	Description
Display more images		Press  button to increase number of images displayed.
Display fewer images		Press  button to reduce number of images displayed. When four images are displayed, press to view highlighted image full frame.
Toggle full frame playback		Press center of multi selector to switch back and forth between full frame and thumbnail playback.
Highlight images		Use multi selector to highlight images for full-frame playback, playback zoom (  218), or deletion (  220).
Delete highlighted photo		See page 220 for more information.
Change protect status of highlighted photo		See page 219 for more information.
Return to shooting mode	 / 	Monitor will turn off. Photographs can be taken immediately.
Display menus	<b>MENU</b>	See page 243 for more information.

### **Choosing a Memory Card**

If two memory cards are inserted, you can select a memory card for playback by pressing the  button when 72 thumbnails are displayed. The dialog shown at right will be displayed; highlight the desired memory card slot and press  to display a list of folders, then highlight a folder and press  to view the pictures in the selected folder.













### **See Also**

For information on choosing the role played by the center of the multi selector, see Custom Setting f2 (**Multi selector center button**,  291).





# Taking a Closer Look: Playback Zoom

Press the  button to zoom in on the current image. The following operations can be performed while zoom is in effect:

To	Use	Description	
Zoom in or out		Press  to zoom in to maximum of approximately 27 × (large images), 20 × (medium images) or 13 × (small images). Press  to zoom out. While photo is zoomed in, use multi selector to view areas of image not visible in monitor. Keep multi selector pressed to scroll rapidly to other areas of frame. Navigation window is displayed when zoom ratio is altered; area currently visible in monitor is indicated by yellow border.	
View other areas of image			
View other images		Rotate main command dial to view same location in other images at current zoom ratio.	
Select faces		Faces (up to 10) detected during zoom are indicated by white borders in the navigation window. Rotate sub-command dial to scroll display to faces without changing zoom ratio.	
Change protect status		See page 219 for more information.	
Return to shooting mode		Monitor will turn off. Photographs can be taken immediately.	
Display menus	<b>MENU</b>	See page 243 for more information.	



# Protecting Photographs from Deletion

In full-frame, zoom, and thumbnail playback, the  button can be used to protect photographs from accidental deletion. Protected files can not be deleted using the  button or the **Delete** option in the playback menu. Note that protected images *will* be deleted when the memory card is formatted (📖 34, 301).



To protect a photograph:

## 1 Select an image.

Display the image in full-frame playback or playback zoom or highlight it in the thumbnail list.



## 2 Press the button.

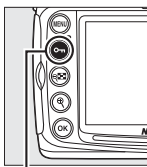

The photograph will be marked with a  icon. To remove protection from the photograph so that it can be deleted, display the photograph or highlight it in the thumbnail list and then press the  button.



 button



### Removing Protection from All Images

To remove protection from all images in the folder or folders currently selected in the **Playback folder** menu, press the  and  buttons together for about two seconds.

# Deleting Photographs

To delete the photograph displayed in full-frame playback or highlighted in the thumbnail list, press the  button. To delete multiple selected photographs or all photographs in the current playback folder, use the **Delete** option in the playback menu. Once deleted, photographs can not be recovered. Note that pictures that are protected or hidden can not be deleted.

## Full-Frame and Thumbnail Playback

Press the  button to delete the current photograph.



### 1 Select an image.

Display the image or highlight it in the thumbnail list.

### 2 Press the button.

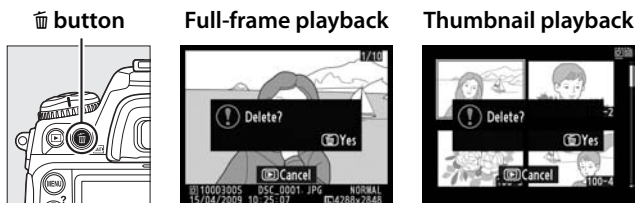
A confirmation dialog will be displayed.



To delete the photograph, press the  button again. To exit without deleting the photograph, press the  button.

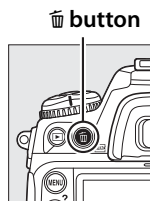

#### See Also

The **After delete** option in the playback menu determines whether the next or previous image is displayed after an image is deleted ( 251).

# The Playback Menu

The **Delete** option in the playback menu contains the following options. Note that depending on the number of images, some time may be required for deletion.

Option	Description
 <b>Selected</b>	Delete selected pictures.
<b>ALL All</b>	Delete all pictures in the folder currently selected for playback (📁 245). If two cards are inserted, you can select the card from which pictures will be deleted.

## ■ Selected: Deleting Selected Photographs



### 1 Choose Selected.

Press the **MENU** button and select **Delete** in the playback menu. Highlight **Selected** and press **▶**.

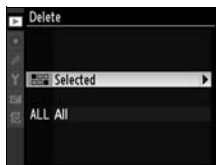
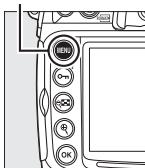
MENU button



### 2 Highlight a picture.

Use the multi selector to highlight a picture (to view the highlighted picture full screen, press and hold the  button; to view images in other locations, press  and select the desired card and folder as described on page 217).



### 3 Select the highlighted picture.

Press the center of the multi selector to select the highlighted picture. Selected pictures are marked by a  icon. Repeat steps 2 and 3 to select additional pictures; to deselect a picture, highlight it and press the center of the multi selector.



### 4 Press **OK** to complete the operation.

A confirmation dialog will be displayed; highlight **Yes** and press **OK**.

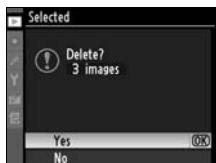



# Connections

## – *Connecting to External Devices*

This chapter describes how to copy photographs to a computer, how to print pictures, and how to view them on a television set.

<b>Connecting to a Computer .....</b>	<b>224</b>
Direct USB Connection .....	225
Wireless and Ethernet Networks .....	227
<b>Printing Photographs .....</b>	<b>228</b>
Connecting the Printer .....	229
Printing Pictures One at a Time .....	230
Printing Multiple Pictures .....	233
Creating a DPOF Print Order: Print Set.....	237
<b>Viewing Photographs on TV .....</b>	<b>239</b>
Standard Definition Devices .....	239
High-Definition Devices .....	241



# Connecting to a Computer

This section describes how to use the supplied UC-E4 USB cable to connect the camera to a computer. Before connecting the camera, install Nikon Transfer and ViewNX from the supplied Software Suite CD (see the *Install Guide* for more information). Nikon Transfer starts automatically when the camera is connected and is used to copy photographs to the computer, where they can be viewed using ViewNX (Nikon Transfer can also be used to back up photographs and embed information in photographs as they are transferred, while ViewNX can be used to sort photographs, convert images to different file formats, process NEF/RAW photographs, and modify NEF/RAW, TIFF, and JPEG images). To ensure that data transfer is not interrupted, be sure the camera battery is fully charged. If in doubt, charge the battery before use or use an EH-5a or EH-5 AC adapter (available separately).

## ■ Supported Operating Systems

The supplied software can be used with computers running the following operating systems:

- **Windows:** Windows Vista Service Pack 1 (32-bit Home Basic/Home Premium/Business/Enterprise/Ultimate) and Windows XP Service Pack 3 (Home Edition/Professional)
- **Macintosh:** Mac OS X (version 10.3.9, 10.4.11, or 10.5.6)

See the websites listed on page xxiv for the latest information on supported operating systems.

### Connecting Cables

Be sure the camera is off when connecting or disconnecting interface cables. Do not use force or attempt to insert the connectors at an angle.

### Camera Control Pro 2

Camera Control Pro 2 (available separately;  355) can be used to control the camera from a computer. When Camera Control Pro 2 is running, “P $\epsilon$ ” will be displayed and the exposure indicator will blink in the control panel.

# Direct USB Connection

Connect the camera using the supplied UC-E4 USB cable.

---

**1** Turn the camera off.

---

**2** Turn the computer on.

Turn the computer on and wait for it to start up.

---

**3** Connect the USB cable.

Connect the USB cable as shown. Do not use force or attempt to insert the connectors at an angle.

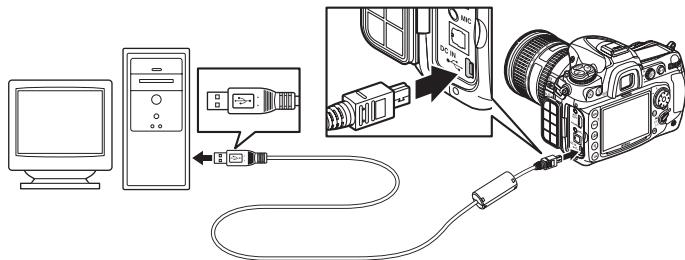

**USB Hubs**

Connect the camera directly to the computer; do not connect the cable via a USB hub or keyboard.

---

**4** Turn the camera on.



---

## 5 Transfer photographs.

Nikon Transfer will start automatically; click the **Start Transfer** button to transfer photographs (for more information on using Nikon Transfer, select **Nikon Transfer help** from the Nikon Transfer **Help** menu).



**Start Transfer** button

---

## 6 Turn the camera off.

Turn the camera off and disconnect the USB cable when transfer is complete.

### **During Transfer**

Do not turn the camera off or disconnect the USB cable while transfer is in progress.

### **Close the Connector Cover**

Close the connector cover when the connectors are not in use. Foreign matter in the connectors can interfere with data transfer.





# Wireless and Ethernet Networks

If the optional WT-4 wireless transmitter (☐ 352) is attached, photographs can be transferred or printed over wireless or Ethernet networks and the camera can also be controlled from network computers running Camera Control Pro 2 (available separately). The WT-4 can be used in any of the following modes:

Mode	Function
Transfer mode	Upload new or existing photographs to computer or ftp server.
Thumbnail select mode	Preview photographs on computer monitor before upload.
PC mode	Control camera from computer using Camera Control Pro 2 (available separately).
Print mode	Print JPEG photographs on printer connected to network computer.

For more information, see the WT-4 user's manual. Be sure to update to the latest versions of the WT-4 firmware and supplied software.

## **Transfer Mode**

When **Wireless transmitter > Mode > Transfer mode** is selected in the camera setup menu, the  button is used during playback to select pictures for upload, preventing it from being used to select pictures for other operations, such as side-by-side comparison (☐ 331). To restore normal operation, select another option for **Wireless transmitter > Mode**.

## **Movies**

The WT-4 can be used to upload movies in transfer mode if **Auto send** or **Send folder** is not selected for **Transfer settings**. Movies can not be uploaded in thumbnail selector mode.

## **WT-4A/B/C/D/E**

The principal difference between the WT-4 and WT-4A/B/C/D/E is in the number of channels supported; unless otherwise stated, all references to the WT-4 also apply to the WT-4A/B/C/D/E.



# Printing Photographs

To print selected JPEG pictures on a PictBridge printer via direct USB connection, follow the steps below.

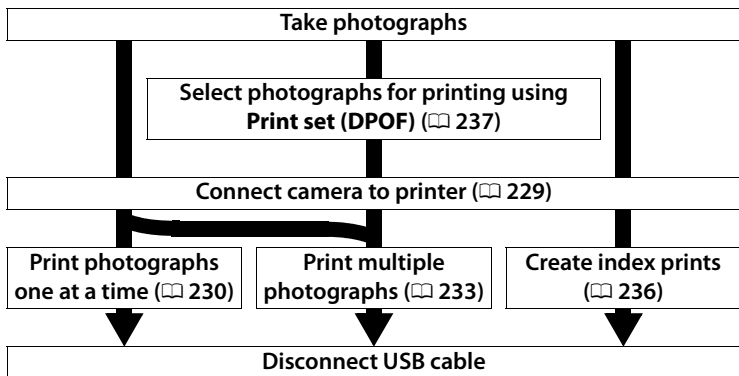

## ✓ Selecting Photographs for Printing

Images created at image quality settings of NEF (RAW) or TIFF (RGB) (p. 68) can not be selected for printing. JPEG copies of NEF (RAW) images can be created using the **NEF (RAW) processing** option in the retouch menu (p. 327).

## ✍ Printing Via Direct USB Connection

Be sure the battery is fully charged or use an optional EH-5a or EH-5 AC adapter. When taking photographs to be printed via direct USB connection, set **Color space** to **sRGB** (p. 166).

## ✍ See Also

See page 384 for information on what to do if an error occurs during printing.

# Connecting the Printer

Connect the camera using the supplied UC-E4 USB cable.

**1** Turn the camera off.

**2** Connect the USB cable.

Turn the printer on and connect the USB cable as shown. Do not use force or attempt to insert the connectors at an angle.

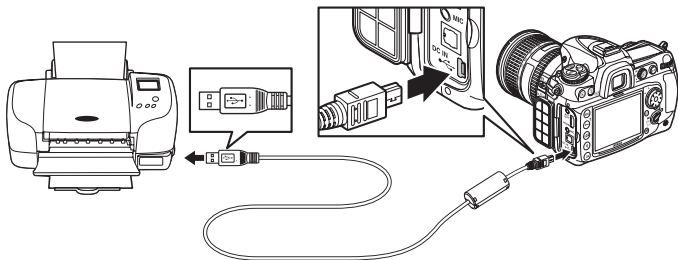

## USB Hubs

Connect the camera directly to the printer; do not connect the cable via a USB hub.

**3** Turn the camera on.

A welcome screen will be displayed in the monitor, followed by a PictBridge playback display.



# Printing Pictures One at a Time

## 1 Select a picture.

Press ◀ or ▶ to view additional pictures. Press ▲ or ▼ to view photo information (□ 207), or press and hold the Ⓚ button to zoom in on the current frame (□ 218). To view six pictures at a time, press the Ⓚ button. Use the multi selector to highlight pictures, or press Ⓚ to display the highlighted picture full frame.



## 2 Display printing options.

Press Ⓚ to display PictBridge printing options.

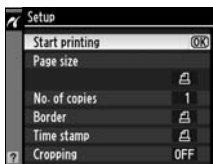

## 3 Adjust printing options.

Press ▲ or ▼ to highlight an option and press ▶ to select.

Option	Description
<b>Page size</b>	Menu shown at right will be displayed. Press ▲ or ▼ to choose page size (to print at default page size for current printer, select <b>Printer default</b> ), then press Ⓚ to select and return to previous menu.
<b>No. of copies</b>	Menu shown at right will be displayed. Press ▲ or ▼ to choose number of copies (maximum 99), then press Ⓚ to select and return to previous menu.

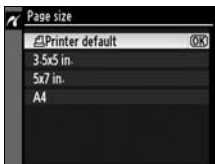

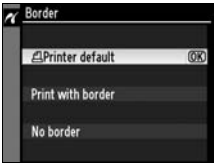
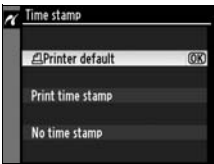
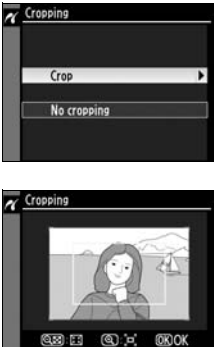

Option	Description	
<b>Border</b>	Menu shown at right will be displayed. Press ▲ or ▼ to choose print style from <b>Printer default</b> (default for current printer), <b>Print with border</b> (print photo with white border), or <b>No border</b> , then press Ⓞ to select and return to previous menu.	
<b>Time stamp</b>	Menu shown at right will be displayed. Press ▲ or ▼ to choose <b>Printer default</b> (default for current printer), <b>Print time stamp</b> (print time and date of recording on photo), or <b>No time stamp</b> , then press Ⓞ to select and return to previous menu.	
<b>Cropping</b>	Menu shown at right will be displayed. To exit without cropping picture, highlight <b>No cropping</b> and press Ⓞ. To crop picture, highlight <b>Crop</b> and press ▶.  If <b>Crop</b> is selected, dialog shown at right will be displayed. Press Ⓞ to increase size of crop, Ⓞ to decrease. Choose position of crop using multi selector and press Ⓞ.	

### **Page Size, Border, Time Stamp, and Cropping**

Choose printer default to print at current printer settings. Only options supported by the current printer can be selected. Note that print quality may drop if small crops are printed at large sizes.



## 4 Start printing.

Select **Start printing** and press  to start printing. To cancel before all copies have been printed, press .

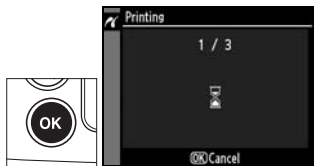

# Printing Multiple Pictures

## 1 Display the PictBridge menu.

Press the **MENU** button in the PictBridge playback display (see Step 3 on page 229).



## 2 Choose Print select or Print (DPOF).

Highlight one of the following options and press **▶**.



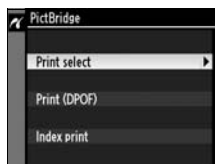





- **Print select:** Select pictures for printing.
- **Print (DPOF):** Print an existing print order created with the **Print set (DPOF)** option in the playback menu (📖 237). The current print order will be displayed in Step 3.



To create an index print of all JPEG pictures on the memory card, select **Index print**. See page 236 for more information.



### 3 Select pictures.

Use the multi selector to scroll through the pictures on the memory card. To display the current picture full screen, press and hold the  button. To select the current picture for printing, press the  button and press . The picture will be marked with a  icon and the number of prints will be set to 1. Keeping the  button pressed, press  or  to specify the number of prints (up to 99; to deselect the picture, press  when the number of prints is 1). Continue until all the desired pictures have been selected.

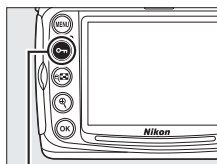

 button

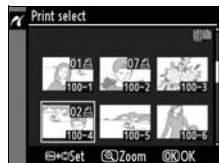

### 4 Display printing options.

Press  to display PictBridge printing options.

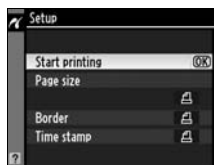



## 5 Adjust printing options.

Press ▲ or ▼ to highlight an option and press ► to select.

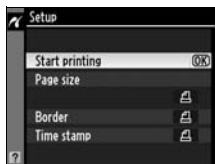

Option	Description
Page size	Menu of page size options will be displayed (☐ 230). Press ▲ or ▼ to choose page size (to print at default page size for current printer, select <b>Printer default</b> ), then press OK to select and return to previous menu.
Border	Menu of border options will be displayed (☐ 231). Press ▲ or ▼ to choose print style from <b>Printer default</b> (default for current printer), <b>Print with border</b> (print photo with white border), or <b>No border</b> , then press OK to select and return to previous menu.
Time stamp	Menu of time stamp options will be displayed (☐ 231). Press ▲ or ▼ to choose <b>Printer default</b> (default for current printer), <b>Print time stamp</b> (print time and date of recording on photo), or <b>No time stamp</b> , then press OK to select and return to previous menu.

## 6 Start printing.

Select **Start printing** and press OK to start printing. To cancel before all copies have been printed, press OK.



## ■ Creating Index Prints

To create an index print of all JPEG pictures on the memory card, select **Index print** in Step 2 of “Printing Multiple Pictures” (□ 233). Note that if the memory card contains more than 256 pictures, only the first 256 images will be printed.

### 1 Select Index print.

Highlight **Index print** in the PictBridge menu (□ 233) and press ►.

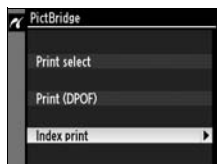

The confirmation dialog shown at right will be displayed.



### 2 Display printing options.

Press **OK** to display PictBridge printing options.

### 3 Adjust printing options.

Choose page size, border, and time stamp options as described on page 235 (a warning will be displayed if the selected page size is too small).

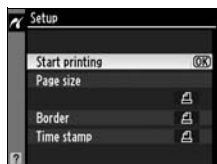

### 4 Start printing.

Highlight **Start printing** and press **OK** to start printing. To cancel before printing is complete, press **OK**.



# Creating a DPOF Print Order: Print Set

The **Print set (DPOF)** option in the playback menu is used to create digital “print orders” for PictBridge-compatible printers and devices that support DPOF.

## 1 Choose Select/set.

Press the **MENU** button and select **Print set (DPOF)** in the playback menu. Highlight **Select/set** and press **▶** (to remove all photographs from the print order, select **Deselect all?**).

MENU button

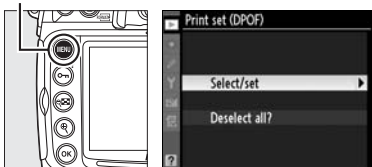

## 2 Select pictures.

Use the multi selector to scroll through the pictures on the memory card (to view images in other locations, press **Q** and select the desired card and folder as described on page 217). To display the current picture in full screen, press and hold the **Q** button. To select the current picture for printing, press the **OK** button and press **▲**. The picture will be marked with a **1** icon and the number of prints will be set to 1. Keeping the **OK** button pressed, press **▲** or **▼** to specify the number of prints (up to 99; to deselect the picture, press **▼** when the number of prints is 1). Press **OK** when all the desired pictures have been selected.

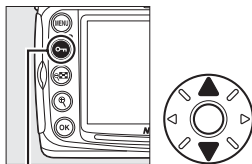

OK button



### 3 Select imprint options.

Highlight the following options and press **▶** to toggle the highlighted option on or off (to complete the print order without including this information, proceed to Step 4).

- **Data imprint:** Print shutter speed and aperture on all pictures in print order.
- **Imprint date:** Print date of recording on all pictures in print order.

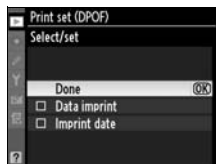

### 4 Complete the print order.

Highlight **Done** and press **OK** to complete the print order.

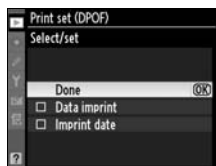

#### **Print Set**

To print the current print order when the camera is connected to a PictBridge printer, select **Print (DPOF)** in the PictBridge menu and follow the steps in "Printing Multiple Pictures" to modify and print the current order (☞ 233). DPOF date and data imprint options are not supported when printing via direct USB connection; to print the date of recording on photographs in the current print order, use the PictBridge **Time stamp** option.

The Print Set option can not be used if there is not enough space on the memory card to store the print order.

Images created at image quality settings of NEF (RAW; ☞ 68) can not be selected for printing using this option.

Print orders may not print correctly if images are deleted using a computer or other device after the print order is created.

# Viewing Photographs on TV

The supplied EG-D2 audio/video (A/V) cable can be used to connect the D300S to a television or VCR for playback or recording. A type C mini-pin High-Definition Multimedia Interface (HDMI) cable (available separately from commercial sources) can be used to connect the camera to high-definition video devices.

## Standard Definition Devices

To connect the camera to a standard television:

### 1 Turn the camera off.

Always turn the camera off before connecting or disconnecting the A/V cable.

### 2 Connect the supplied A/V cable as shown.

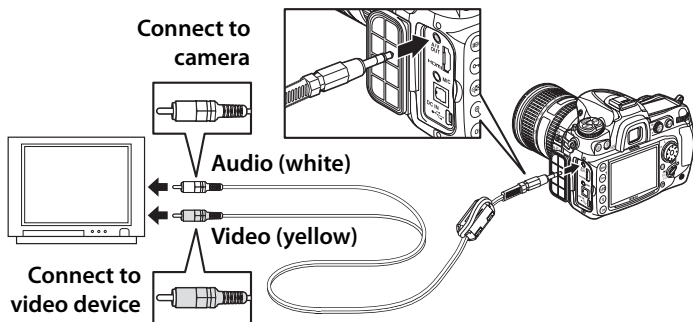

### 3 Tune the television to the video channel.

### 4 Turn the camera on and press button.

During playback, images will be displayed both on the television screen and in the camera monitor.

### **Video Mode**

If no image is displayed, check that camera is correctly connected and that the option selected for **Video mode** (☞ 301) matches the video standard used in the TV.

### **Television Playback**

Use of an EH-5a or EH-5 AC adapter (available separately) is recommended for extended playback. When the EH-5a or EH-5 is connected, the camera monitor-off delay will be fixed at ten minutes and the exposure meters will no longer turn off automatically. Note that the edges may not be visible when photographs are viewed on a television screen.

### **Slide Shows**

The **Slide show** option in the playback menu can be used for automated playback (☞ 252).

### **Audio**

When a movie with sound recorded in stereo using an external microphone is viewed on a television connected to the camera via an A/V cable, the audio output is monaural. HDMI connections support stereo output. Volume can be adjusted using television controls; the camera controls can not be used.



# High-Definition Devices

The camera can be connected to HDMI devices using a type C mini-pin HDMI cable (available separately from commercial sources).

## 1 Turn the camera off.

Always turn the camera off before connecting or disconnecting an HDMI cable.

## 2 Connect the HDMI cable as shown.

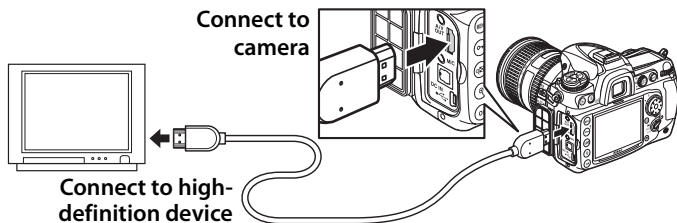

## 3 Tune the device to the HDMI channel.

## 4 Turn the camera on and press button.

During playback, images will be displayed on the high-definition television or monitor screen; the camera monitor will remain off.

### **Movies**

To display or hide a guide in the monitor when viewing movies on an HDMI device, press the  button.

### **HDMI**

At the default setting of **Auto**, the camera automatically selects the appropriate HDMI format for the high-definition device. The HDMI format can be chosen using the **HDMI** option in the setup menu ( 302).















# Menu Guide

This chapter describes the options available in the camera menus.

 The Playback Menu: Managing Images .....	244
 The Shooting Menu: Shooting Options.....	253
 Custom Settings: Fine-Tuning Camera Settings.....	260
 The Setup Menu: Camera Setup.....	300
 The Retouch Menu: Creating Retouched Copies.....	315
 My Menu: Creating a Custom Menu .....	333



# ▶ The Playback Menu: *Managing Images*

To display the playback menu, press **MENU** and select the ▶ (playback menu) tab.

## MENU button



Option	📖
Delete	221
Playback folder	245
Hide image	245
Display mode	247
Copy image(s)	248
Image review	251
After delete	251
Rotate tall	251
Slide show	252
Print set (DPOF)	237



## Playback Folder

MENU button →  playback menu

Choose a folder for playback.

Option	Description
D300S	Pictures in all folders created with the D300S will be visible during playback.
All	Pictures in all folders will be visible during playback.
Current	Only pictures in the current folder will be visible during playback.

## Hide Image

MENU button →  playback menu

Hide or reveal selected pictures as described below. Hidden pictures are visible only in the **Hide image** menu and can only be deleted by formatting the memory card.

### Protected and Hidden Images

Revealing a protected image will also remove protection from the image.

## 1 Choose Select/set.

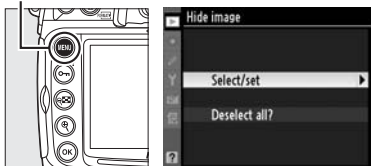

Press the MENU button and select **Hide image** in the playback menu. Highlight **Select/set** and press ► (to skip the remaining steps and reveal all pictures, highlight **Deselect all?** and press ►).

MENU button



## 2 Select pictures.

Use the multi selector to scroll through the pictures on the memory card (to view the highlighted picture full screen, press and hold the  button;

to view images in other locations, press  and select the desired card and folder as described on page 217) and press the center of the multi selector to select the current picture. Selected pictures are marked by a  icon; to deselect a picture, highlight it and press the center of the multi selector.



## 3 Press .

Press  to complete the operation.



Choose the information available in the playback photo information display ( 207).

## 1 Select options.

Press ▲ or ▼ to highlight an option, then press ► to select the option for the photo information display. A ✓ appears next to selected items; to deselect, highlight and press ►.



## 2 Save changes and exit.

To return to the playback menu, highlight **Done** and press .

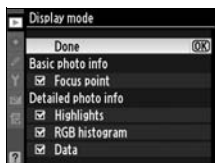

Copy images between memory cards. This option is only available when two memory cards are inserted in the camera.

Option	Description
Select source	Select the card from which pictures will be copied.
Select image(s)	Select the pictures to be copied.
Select destination folder	Select the folder to which pictures will be copied.
Copy image(s)?	Copy the images.

To copy images:

## 1 Choose Select source.

Highlight **Select source** and press .

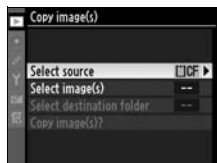

## 2 Select the source card.

Highlight the slot containing the card from which images will be copied and press .



## 3 Choose Select image(s).

Highlight **Select image(s)** and press .

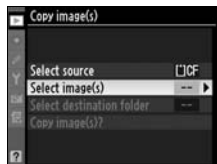

## 4 Select the source folder.

Highlight the folder containing the images to be copied and press .

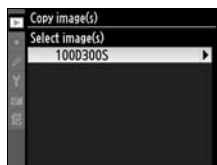

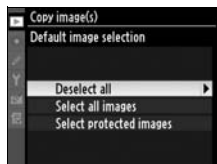

## 5 Make the initial selection.

Before going on select or deselect individual images, you can mark all or all protected images in the folder for copying by choosing **Select all images** or **Select protected images**. To mark only individually selected images for copying, choose **Deselect all** before proceeding.



## 6 Select additional images.

Highlight pictures and press the center of the multi selector to select or deselect (to view the highlighted picture full screen, press and hold the  button). Selected images are marked with a ✓. Press  to proceed to Step 7 when your selection is complete.



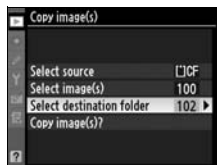

## 7 Choose **Select destination folder**.

Highlight **Select destination folder** and press .



## 8 Select a destination folder.

To enter a folder number, choose **Select folder by number**, enter the number ( 256), and press . If the folder with the selected number does not already exist, a new folder will be created.



To choose from a list of existing folders, choose **Select folder from list**, highlight a folder, and press **OK**.

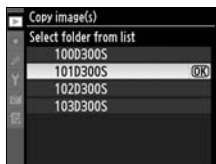

## 9 Copy the images.

Highlight **Copy image(s)?** and press **▶**.

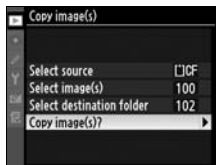

A confirmation dialog will be displayed; highlight **Yes** and press **OK**. Press **OK** again to exit when copying is complete.

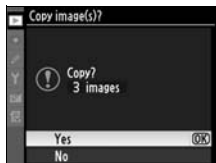

### ✔ Copying Images

Images will not be copied if there is insufficient space on the destination card. Be sure the battery is fully charged before copying movies.

If the destination folder contains an image with the same name as one of the images to be copied, a confirmation dialog will be displayed. Select **Replace existing image** to replace the image with the image to be copied, or select **Replace all** to replace all existing images with the same names without further prompting. To continue without replacing the image, select **Skip**, or select **Cancel** to exit without copying any further images.



Protect status is copied with the images but print marking (📖 237) is not. Hidden images can not be copied.



## Image Review

MENU button →  playback menu



Choose whether pictures are automatically displayed in the monitor immediately after shooting. If **Off** is selected, pictures can only be displayed by pressing the  button.



## After Delete

MENU button →  playback menu

Choose the picture displayed after an image is deleted.



Option	Description
 <b>Show next</b>	Display following picture. If deleted picture was last frame, previous picture will be displayed.
 <b>Show previous</b>	Display previous picture. If deleted picture was first frame, following picture will be displayed.
 <b>Continue as before</b>	If user was scrolling through pictures in order recorded, following picture will be displayed as described for <b>Show next</b> . If user was scrolling through pictures in reverse order, previous picture will be displayed as described for <b>Show previous</b> .

## Rotate Tall

MENU button →  playback menu











Choose whether to rotate “tall” (portrait-orientation) pictures for display during playback. Note that because the camera itself is already in the appropriate orientation during shooting, images are not rotated automatically during image review.

Option	Description
<b>On</b>	“Tall” (portrait-orientation) pictures are automatically rotated for display in the camera monitor. Pictures taken with <b>Off</b> selected for <b>Auto image rotation</b> (  304) will be displayed in “wide” (landscape) orientation.
<b>Off</b>	“Tall” (portrait-orientation) pictures are displayed in “wide” (landscape) orientation.

Create a slide show of the pictures in the current playback folder ( 245). Hidden images ( 245) are not displayed.

Option	Description
<b>Start</b>	Start slide show.
<b>Frame interval</b>	Choose how long each picture will be displayed.

To start the slide show, highlight **Start** and press . The following operations can be performed while the slide show is in progress:

To	Press	Description
Skip back/skip ahead		Press  to return to previous frame,  to skip to next frame.
View additional photo info		Change photo info displayed (  207).
Pause/resume		Pause or resume slide show.
Exit to playback menu	<b>MENU</b>	End slide show and return to playback menu.
Exit to playback mode		End slide show and exit to full-frame (  204) or thumbnail playback (  216).
Exit to shooting mode		Press shutter-release button halfway to return to shooting mode.

The dialog shown at right is displayed when the show ends. Select **Restart** to restart or **Exit** to return to the playback menu.



# The Shooting Menu: *Shooting Options*

To display the shooting menu, press **MENU** and select the  (shooting menu) tab.

## MENU button



Option	
Shooting menu bank	254
Reset shooting menu	256
Active folder	256
File naming	258
Primary slot selection	72
Secondary slot function	72
Image quality	68
Image size	71
JPEG compression	70
NEF (RAW) recording	70
White balance	134
Set Picture Control	154
Manage Picture Control	160
Color space	166
Active D-Lighting	164
Long exp. NR	258
High ISO NR	259
ISO sensitivity settings	96
Live view mode	49, 52
Multiple exposure	184
Movie settings	62
Interval timer shooting	189

Shooting menu options are stored in one of four banks. With the exceptions of **Interval timer shooting**, **Multiple exposure**, and modifications to Picture Controls (quick adjust and other manual adjustments), changes to settings in one bank have no effect on the others. To store a particular combination of frequently-used settings, select one of the four banks and set the camera to these settings. The new settings will be stored in the bank even when the camera is turned off, and will be restored the next time the bank is selected. Different combinations of settings can be stored in the other banks, allowing the user to switch instantly from one combination to another by selecting the appropriate bank from the bank menu. The default names for the four shooting menu banks are A, B, C, and D. A descriptive caption can be added using the **Rename** option as described below.

### Shooting Menu Bank

The current menu bank is shown in the information display, which can be viewed by pressing the  button.

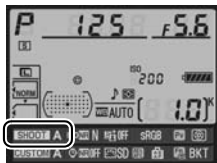

## Renaming Shooting Menu Banks



Selecting **Rename** in the **Shooting menu bank** menu displays the list of shooting menu banks shown in Step 1.

### 1 Select a bank.

Highlight the desired bank and press .



## 2 Enter a name.

To move the cursor in the name area, press the  button and press ◀ or ▶. To enter a new letter at the current cursor position, use the multi selector to highlight the desired character in the keyboard area and press the center of the multi selector. To delete the character at the current cursor position, press the  button. To return to the shooting menu without changing the bank name, press the MENU button.



### Keyboard area



### Name area

Bank names can be up to twenty characters long. Any characters after the twentieth will be deleted.

## 3 Save changes and exit.

After editing the name, press  to save changes and exit. The **Shooting menu bank** menu will be displayed.

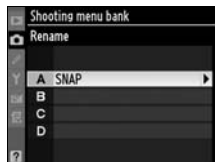

Select **Yes** to restore default settings for the current shooting menu bank. See page 368 for a list of default settings.



Select the folder in which subsequent images will be stored.



## ■ ■ *New Folder Number*

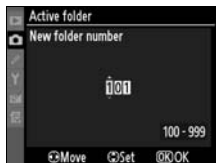

### 1 Select New folder number.

Highlight **New folder number** and press **▶**. The dialog shown at right will be displayed.



### 2 Choose a folder number.

Press **◀** or **▶** to highlight a digit, press **▲** or **▼** to change. If a folder with the selected number already exists, a , , or  icon will be displayed to the left of the folder number:

-  : Folder is empty.
-  : Folder is partially full.
-  : Folder contains 999 pictures or a picture numbered 9999. No further pictures can be stored in this folder.

### 3 Save changes and exit.

Press **OK** to complete the operation and return to the shooting menu (to exit without changing the active folder, press the **MENU** button). If a folder with the specified number does not already exist, a new folder will be created. Subsequent photographs will be stored in the selected folder unless it is already full.

## ■ Select Folder

### 1 Choose Select folder.

Highlight **Select folder** and press **▶**.

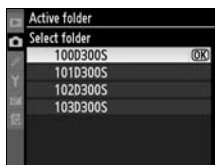

### 2 Highlight a folder.

Press **▲** or **▼** to highlight a folder.

### 3 Select the highlighted folder.

Press **OK** to select the highlighted folder and return to the shooting menu (to exit without changing the active folder, press the **MENU** button). Subsequent photographs will be stored in the selected folder.

#### **Folder and File Numbers**

If the current folder is numbered 999 and contains 999 pictures or a picture numbered 9999, the shutter-release will be disabled and no further photographs can be taken. To continue shooting, create a folder with a number less than 999, or select an existing folder with a number less than 999 and less than 999 images.

#### **Number of Folders**

Additional time may be required for camera startup if the memory card contains a very large number of folders.



Photographs are saved using file names consisting of “DSC\_” or, in the case of images that use the Adobe RGB color space, “\_DSC”, followed by a four-digit number and a three-letter extension (e.g., “DSC\_0001.JPG”). The **File naming** option is used to select three letters to replace the “DSC” portion of the file name. For information on editing file names, see steps 2 and 3 of “Renaming Shooting Menu Banks” (☐ 254). Note that the portion of the name that can be edited is a maximum of three characters long.

### Extensions

The following extensions are used: “.NEF” for NEF (RAW) images, “.TIF” for TIFF (RGB) images, “.JPG” for JPEG images, “.AVI” for movies, and “.NDF” for dust off reference data. In each pair of photographs recorded at image-quality settings of NEF (RAW)+JPEG, the NEF and JPEG images have the same file names but different extensions.

## Long Exp. NR (Long Exposure Noise Reduction)

If **On** is selected, photographs taken at shutter speeds slower than 8 s will be processed to reduce noise. The time required for processing is roughly equal to the current shutter speed; during processing, “**Job nr**” will blink in the shutter speed/aperture displays and pictures can not be taken (if the camera is turned off before processing is complete, the picture will be saved but noise reduction will not be performed). In continuous release mode, frame rates will slow and while photographs are being processed, the capacity of the memory buffer will drop.

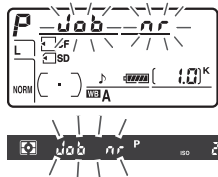



Photographs taken at high ISO sensitivities can be processed to reduce “noise.”

Option	Description	
HIGH <b>High</b>	Noise reduction is performed at ISO sensitivities of ISO 800 and higher. While photographs are being processed, the capacity of the memory buffer will drop. Choose the amount of noise reduction performed from <b>High</b> , <b>Normal</b> , and <b>Low</b> .	
NORM <b>Normal</b>		
LOW <b>Low</b>		
<b>Off</b>	Noise reduction is only performed at sensitivities of Hi 0.3 and higher. The amount of noise reduction is less than the amount performed when <b>Low</b> is selected for <b>High ISO NR</b> .	



# Custom Settings: Fine-Tuning Camera Settings

To display the Custom Settings menu, press **MENU** and select the  (Custom Settings menu) tab.

## MENU button



Custom Settings are used to customize camera settings to suit individual preferences.

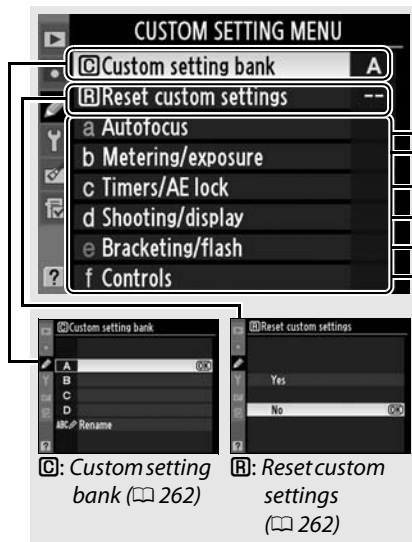

## Main menu



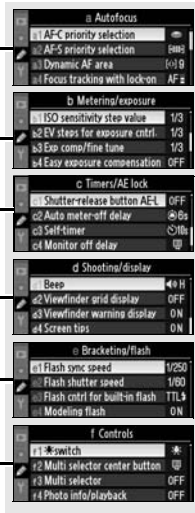

## Custom Setting groups



The following Custom Settings are available:

Custom Setting		
	<b>Custom setting bank</b>	262
	<b>Reset custom settings</b>	262
<b>a Autofocus</b>		
a1	AF-C priority selection	263
a2	AF-S priority selection	264
a3	Dynamic AF area	264
a4	Focus tracking with lock-on	266
a5	AF activation	266
a6	AF point illumination	266
a7	Focus point wrap-around	267
a8	AF point selection	267
a9	Built-in AF-assist illuminator	268
a10	AF-ON for MB-D10	269
<b>b Metering/exposure</b>		
b1	ISO sensitivity step value	270
b2	EV steps for exposure cntrl.	270
b3	Exp comp/fine tune	270
b4	Easy exposure compensation	271
b5	Center-weighted area	272
b6	Fine tune optimal exposure	272
<b>c Timers/AE lock</b>		
c1	Shutter-release button AE-L	273
c2	Auto meter-off delay	273
c3	Self-timer	273
c4	Monitor off delay	274
<b>d Shooting/display</b>		
d1	Beep	275
d2	Viewfinder grid display	275
d3	Viewfinder warning display	275
d4	Screen tips	276

Custom Setting		
<b>d Shooting/display</b>		
d5	CL mode shooting speed	276
d6	Max. continuous release	276
d7	File number sequence	277
d8	Information display	278
d9	LCD illumination	278
d10	Exposure delay mode	278
d11	MB-D10 battery type	279
d12	Battery order	280
<b>e Bracketing/flash</b>		
e1	Flash sync speed	281
e2	Flash shutter speed	282
e3	Flash cntrl for built-in flash	283
e4	Modeling flash	289
e5	Auto bracketing set	289
e6	Auto bracketing (Mode M)	290
e7	Bracketing order	290
<b>f Controls</b>		
f1	 switch	291
f2	Multi selector center button	291
f3	Multi selector	292
f4	Photo info/playback	292
f5	Assign Fn button	292
f6	Assign preview button	296
f7	Assign AE-L/AF-L button	296
f8	Customize command dials	297
f9	Release button to use dial	298
f10	No memory card?	299
f11	Reverse indicators	299



Custom Settings are stored in one of four banks. Changes to settings in one bank have no effect on the others. To store a particular combination of frequently-used settings, select one of the four banks and set the camera to these settings. The new settings will be stored in the bank even when the camera is turned off, and will be restored the next time the bank is selected. Different combinations of settings can be stored in the other banks, allowing the user to switch instantly from one combination to another by selecting the appropriate bank from the bank menu.

The default names for the four Custom Settings banks are A, B, C, and D. A descriptive caption can be added using the **Rename** option as described on page 255.

** Custom Settings Bank**

The bank letter is shown in the information display, which can be viewed by pressing the  button. If settings in the current bank have been modified from default values, an asterisk will be displayed adjacent to the altered settings in the second level of the Custom Settings menu.

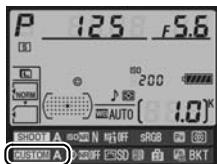
**Ⓢ: Reset Custom Settings**

Select **Yes** to restore default settings for the current Custom Settings bank. See page 369 for a list of default settings. Custom settings are not reset when a two-button reset is performed.



# a: Autofocus



## a1: AF-C Priority Selection

MENU button →  Custom Settings menu

This option controls whether photographs can be taken whenever the shutter-release button is pressed (*release priority*) or only when the camera is in focus (*focus priority*) in continuous-servo AF. To select continuous-servo AF, rotate the focus mode selector to **C**.

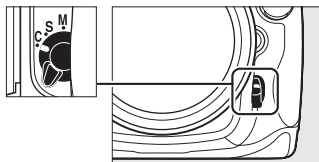
### Focus mode selector



Option	Description
 <b>Release</b>	Photos can be taken whenever the shutter-release button is pressed.
 <b>Release + focus</b>	Photos can be taken even when the camera is not in focus. In continuous mode, frame rate slows for improved focus if the subject is dark or low contrast.
 <b>Focus</b>	Photos can only be taken when the in-focus indicator (●) is displayed.

Regardless of the option selected, focus will not lock when the in-focus indicator (●) is displayed.





## a2: AF-S Priority Selection

MENU button →  Custom Settings menu

This option controls whether photographs can be taken only when the camera is in focus (*focus priority*) or whenever the shutter-release button is pressed (*release priority*) in single-servo AF. To select single-servo AF, rotate the focus mode selector to **S**.

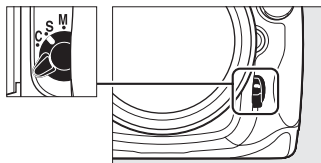
### Focus mode selector







Option	Description
 <b>Release</b>	Photos can be taken whenever the shutter-release button is pressed.
 <b>Focus</b>	Photos can only be taken when the in-focus indicator (●) is displayed.



Regardless of the option selected, focus will lock while the in-focus indicator (●) is displayed.

## a3: Dynamic AF Area

MENU button →  Custom Settings menu

If the subject leaves the selected focus point when dynamic-area AF (;  76) is selected in continuous-servo AF (focus mode **C**;  74), the camera will focus based on information from surrounding focus points. Choose the number of focus points from 9, 21, and 51 based on subject movement (note that only active focus point is displayed in the viewfinder; the remaining focus points provide information to assist focus operation).

Option	Description
 <b>9 points</b> 	If the subject leaves the selected focus point, the camera will focus based on information from the surrounding eight focus points. Choose when there is time to compose the photograph or when photographing subjects that are moving predictably (e.g., runners or race cars on a track).

Option	Description
[e]21 <b>21 points</b> 	If the subject leaves the selected focus point, the camera will focus based on information from the surrounding 20 focus points. Choose when photographing subjects that are moving unpredictably (e.g., players at a football game).
[e]51 <b>51 points</b> 	If the subject leaves the selected focus point, the camera will focus based on information from the surrounding 50 focus points. Choose when photographing subjects that are moving quickly and can not be easily framed in the viewfinder (e.g., birds).
[e]3D <b>51 points</b> <b>(3D-tracking)</b> 	If the subject leaves the selected focus point, the camera will use 3D-tracking to track the subject and select a new focus point as required. Use to quickly compose pictures with subjects that are moving erratically from side to side (e.g., tennis players). If the subject leaves the viewfinder, remove your finger from the shutter-release button and recompose the photograph with the subject in the selected focus point.



### 3D-tracking

When the shutter-release button is pressed halfway, the colors in the area surrounding the focus point are stored in the camera.

Consequently 3D-tracking may not produce the desired results with subjects that are the same color as the background or that occupy a very small area of the frame.



## a4: Focus Tracking with Lock-On MENU button → Custom Settings menu

This option controls how autofocus adjusts to sudden large changes in the distance to the subject.

Option	Description
AF  Long	When the distance to the subject changes abruptly, the camera waits for the specified period (long, normal, or short) before adjusting the distance to the subject. This prevents the camera from refocusing when the subject is briefly obscured by objects passing through the frame.
AF  Normal	
AF  Short	
Off	The camera immediately adjusts focus when the distance to the subject changes. Use when photographing a series of subjects at varying distances in quick succession.

## a5: AF Activation

MENU button → Custom Settings menu

If **Shutter/AF-ON** is selected, both the shutter-release button and the **AF-ON** button can be used to initiate autofocus. If **AF-ON only** is selected, autofocus is only initiated when the **AF-ON** button is pressed.

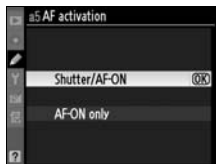

## a6: AF Point Illumination

MENU button → Custom Settings menu

Choose whether the active focus point is highlighted in red in the viewfinder.



Option	Description
Auto	The selected focus point is automatically highlighted as needed to establish contrast with the background.
On	The selected focus point is always highlighted, regardless of the brightness of the background. Depending on the brightness of the background, the selected focus point may be difficult to see.
Off	The selected focus point is not highlighted.



## a7: Focus Point Wrap-Around

MENU button →  Custom Settings menu

Choose whether focus-point selection “wraps around” from one edge of the viewfinder to another.

Option	Description
<b>Wrap</b>	Focus-point selection “wraps around” from top to bottom, bottom to top, right to left, and left to right, so that, for example, pressing  when a focus point at the right edge of the viewfinder display is highlighted (①) selects the corresponding focus point at the left edge of the display (②). 
<b>No wrap</b>	The focus-area display is bounded by the outermost focus points so that, for example, pressing  when a focus point at the right edge of the display is selected has no effect.

## a8: AF Point Selection

MENU button →  Custom Settings menu

Choose the number of focus points available for manual focus-point selection.

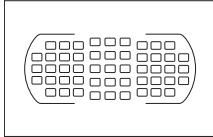
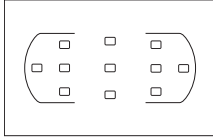
Option	Description
<b>AF51 51 points</b>	Choose from the 51 focus points shown at right. 
<b>AF11 11 points</b>	Choose from the 11 focus points shown at right. Use for quick focus-point selection. 



Choose whether the built-in AF-assist illuminator lights to assist the focus operation when lighting is poor.

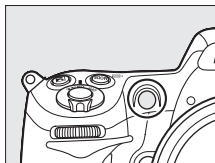

Option	Description
<b>On</b>	The AF-assist illuminator lights when lighting is poor. AF-assist illumination is only available when both of the following conditions are met: <ol style="list-style-type: none"><li>1. Single-servo autofocus is selected for focus mode (□ 74).</li><li>2. Auto-area AF is chosen for AF-area mode (□ 76), or single-point or dynamic-area AF is chosen and the center focus point is selected.</li></ol>
<b>Off</b>	The AF-assist illuminator does not light to assist the focus operation. The camera may not be able to focus using autofocus when lighting is poor.

### **The AF-Assist Illuminator**

The AF-assist illuminator has a range of about 0.5–3.0 m (1 ft. 8 in.–9 ft. 10 in.); when using the illuminator, use a lens with a focal length of 24–200 mm and remove the lens hood.

### **See Also**







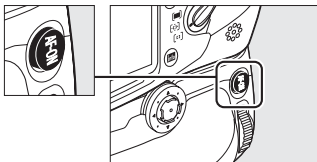

See page 345 for restrictions on the lenses that can be used with AF assist.

## a10: AF-On for MB-D10

MENU button →  Custom Settings menu

Choose the function assigned to the AF-ON button on the optional MB-D10 battery pack.



Option	Description
 <b>AF-ON</b>	Pressing the MB-D10 <b>AF-ON</b> button initiates autofocus.
 <b>AE/AF lock</b>	Focus and exposure lock while the MB-D10 <b>AF-ON</b> button is pressed.
 <b>AE lock only</b>	Exposure locks while the MB-D10 <b>AF-ON</b> button is pressed.
 <b>AE lock (Reset on release)</b>	Exposure locks when the MB-D10 <b>AF-ON</b> button is pressed, and remains locked until the button is pressed a second time, the shutter is released or the exposure meters turn off.
 <b>AE lock (Hold)</b>	Exposure locks when the MB-D10 <b>AF-ON</b> button is pressed, and remains locked until the button is pressed a second time or the exposure meters turn off.
 <b>AF lock only</b>	Focus locks while the MB-D10 <b>AF-ON</b> button is pressed.
 <b>Same as Fn button</b>	The MB-D10 <b>AF-ON</b> button performs the function selected for Custom Setting f5 (  292).

### VR Lenses

Vibration reduction can not be initiated by pressing the **AF-ON** button.



## b: Metering/Exposure

### b1: ISO Sensitivity Step Value

MENU button →  Custom Settings menu

Select the increments used when making adjustments to ISO sensitivity.

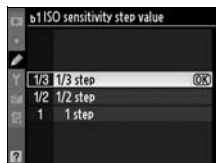

### b2: EV Steps for Exposure Cntrl.

MENU button →  Custom Settings menu

Select the increments used when making adjustments to shutter speed, aperture, and bracketing.



### b3: Exp Comp/Fine Tune



MENU button →  Custom Settings menu

Select the increments used when making adjustments to exposure and flash compensation.



## b4: Easy Exposure Compensation MENU button → Custom Settings menu

This option controls whether the  button is needed to set exposure compensation (□ 118). If **On (Auto reset)** or **On** is selected, the 0 at the center of the exposure display will blink even when exposure compensation is set to  $\pm 0$ .

Option	Description
RESET <b>On (Auto reset)</b>	Exposure compensation is set by rotating one of the command dials (see note below). The setting selected using the command dial is reset when the camera or exposure meters turn off (exposure compensation settings selected using the  button are not reset).
<b>On</b>	As above, except that the exposure compensation value selected using the command dial is not reset when the camera or exposure meters turn off.
<b>Off</b>	Exposure compensation is set by pressing the  button and rotating the main command dial.

### Change Main/Sub

The dial used to set exposure compensation when **On (Auto reset)** or **On** is selected for Custom Setting b4 (**Easy exposure compensation**) depends on the option selected for Custom Setting f8 (**Customize command dials**) > **Change main/sub** (□ 297).

		Customize command dials > Change main/sub	
		Off	On
Exposure mode	P	Sub-command dial	Sub-command dial
	S	Sub-command dial	Main command dial
	A	Main command dial	Sub-command dial
	M	N/A	



## b5: Center-Weighted Area

MENU button →  Custom Settings menu

When calculating exposure, center-weighted metering assigns the greatest weight to a circle in the center of the frame. The diameter ( $\phi$ ) of this circle can be set to 6, 8, 10, or 13 mm or to the average of the entire frame.

Option
(◀) 6 $\phi$ 6 mm
(◀) 8 $\phi$ 8 mm
(◀) 10 $\phi$ 10 mm
(◀) 13 $\phi$ 13 mm
(◀) Avg Average

Note that the diameter is fixed at 8 mm when a non-CPU lens is used.



## b6: Fine Tune Optimal Exposure

MENU button →  Custom Settings menu

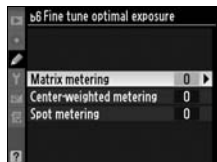
Use this option to fine-tune the exposure value selected by the camera. Exposure can be fine tuned separately for each metering method by from +1 to -1 EV in steps of  $\frac{1}{6}$  EV.



### Fine-Tuning Exposure

Exposure can be fine-tuned separately for each Custom Settings bank and is not affected by two-button resets. Note that as the exposure compensation () icon is not displayed, the only way to determine how much exposure has been altered is to view the amount in the fine-tuning menu. Exposure compensation ( 118) is preferred in most situations.



## c: Timers/AE Lock

### c1: Shutter-Release Button AE-L MENU button → Custom Settings menu

At the default setting of **Off**, exposure only locks when the **AE-L/AF-L** button is pressed. If **On** is selected, exposure will also lock when the shutter-release button is pressed halfway.



### c2: Auto Meter-off Delay

MENU button →  Custom Settings menu

Choose how long the camera continues to meter exposure when no operations are performed. The shutter-speed and aperture displays in the control panel and viewfinder turn off automatically when the exposure meters turn off.

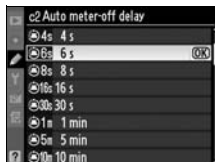

Choose a shorter meter-off delay for longer battery life. When the camera is powered by an optional EH-5a or EH-5 AC adapter, the auto meter-off delay is equivalent to **No limit**.

### c3: Self-Timer

MENU button →  Custom Settings menu

Choose the length of the shutter release delay in self-timer mode.

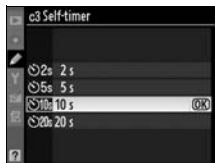

Choose how long the monitor remains on when no operations are performed during playback (**Playback**; defaults to 10 s) and image review (**Image review**; defaults to 4 s) or when menus (**Menus**; defaults to 20 s) or information (**Information display**; defaults to 10 s) are displayed. Choose a shorter monitor-off delay for longer battery life. Regardless of the setting chosen, the monitor remains on if no operations are performed for about ten minutes when the camera is powered by an optional EH-5a or EH-5 AC adapter.







## d: Shooting/Display

### d1: Beep

MENU button →  Custom Settings menu

If **High** (high pitch) or **Low** (low pitch) is selected, a beep will sound at the selected pitch while the self-timer is active or when the camera focuses using single-servo AF. Note that a beep will not sound when the camera focuses during movie recording or in quiet-shutter release mode (mode **Q**) or if **Release** is selected for Custom Setting a2 (**AF-S priority selection**,  264).

 appears in the control panel and information display when the beep is on.

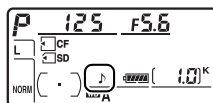

### d2: Viewfinder Grid Display

MENU button →  Custom Settings menu

Choose **On** to display on-demand grid lines in the viewfinder for reference when composing photographs.

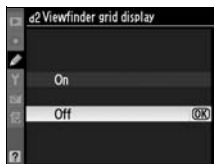

### d3: Viewfinder Warning Display

MENU button →  Custom Settings menu

Choose **On** to display a low battery icon () in the viewfinder when the battery is low.

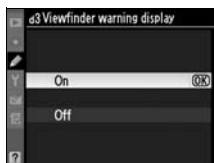

## d4: Screen Tips

MENU button →  Custom Settings menu

Choose **On** to display tool tips for items selected in the information display.



## d5: CL Mode Shooting Speed

MENU button →  Custom Settings menu

Choose the maximum frame advance rate in **CL** (continuous low speed) mode (during interval timer photography, this setting also determines the frame advance rate for single-frame). Note that the frame advance rate may drop below the selected value at slow shutter speeds.

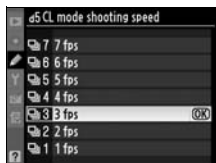

## d6: Max. Continuous Release

MENU button →  Custom Settings menu

The maximum number of shots that can be taken in a single burst in continuous mode can be set to any value between 1 and 100.



### The Memory Buffer

Regardless of the option selected for Custom Setting d6, shooting will slow when the memory buffer fills. See page 394 for more information on the capacity of the memory buffer.



When a photograph is taken, the camera names the file by adding one to the last file number used. This option controls whether file numbering continues from the last number used when a new folder is created, the memory card is formatted, or a new memory card is inserted in the camera.

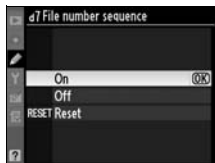

Option	Description
<b>On</b>	When a new folder is created, the memory card formatted, or a new memory card inserted in the camera, file numbering continues from the last number used or from the largest file number in the current folder, whichever is higher. If a photograph is taken when the current folder contains a photograph numbered 9999, a new folder will be created automatically and file numbering will begin again from 0001.
<b>Off</b>	File numbering is reset to 0001 when a new folder is created, the memory card is formatted, or a new memory card is inserted in the camera. Note that a new folder is created automatically if a photograph is taken when the current folder contains 999 photographs.
<b>RESET Reset</b>	Same as for <b>On</b> , except that the next photograph taken is assigned a file number by adding one to the largest file number in the current folder. If the folder is empty, file numbering is reset to 0001.

### File Number Sequence

If the current folder is numbered 999 and contains either 999 photographs or a photograph numbered 9999, the shutter-release button will be disabled and no further photographs can be taken. Choose **Reset** for Custom Setting d7 (**File number sequence**) and then either format the current memory card or insert a new memory card.



## d8: Information Display

MENU button → Custom Settings menu

At the default setting of **Auto (AUTO)**, the color of the lettering in the information display (☞ 12) will automatically change from black to white or white to black to maintain contrast with the background. To always use the same color lettering, select **Manual** and choose **Dark on light (B; black lettering)** or **Light on dark (W; white lettering)**. Monitor brightness will automatically be adjusted for maximum contrast with the selected text color.

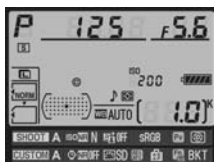

Dark on light



Light on dark

## d9: LCD Illumination

MENU button → Custom Settings menu

At the default setting of **Off**, the control panel backlight (LCD illuminator) will only light while the power switch is rotated toward . If **On** is selected, the control panel will be illuminated while the exposure meters are active (☞ 39). Select **Off** for increased battery life.

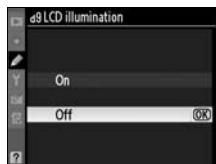



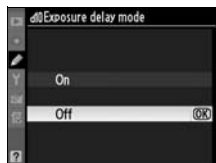

## d10: Exposure Delay Mode

MENU button → Custom Settings menu

At the default setting of **Off**, shutter is released when the shutter-release button is pressed. When shooting with **Tripod** selected in live view mode (☞ 49) or in situations where the slightest camera movement can blur pictures, **On** can be selected to delay shutter release until about 1 s after the shutter-release button is pressed and the mirror is raised.







To ensure that the camera functions as expected when eight AA batteries are used in the optional MB-D10 battery pack, match the option selected in this menu to the type of batteries inserted in the battery pack. There is no need to adjust this option when using EN-EL3e or optional EN-EL4a or EN-EL4 batteries.

Option	Description
 LR6 (AA alkaline)	Select when using LR6 alkaline AA batteries.
 HR6 (AA Ni-MH)	Select when using HR6 Ni-MH AA batteries.
 FR6 (AA lithium)	Select when using FR6 lithium AA batteries.
 ZR6 (AA Ni-Mn)	Select when using ZR6 Ni-Mn AA batteries.

### Using AA Batteries

EN-EL4a or EN-EL4 rechargeable Li-ion batteries (available separately) or EN-EL3e rechargeable Li-ion batteries are recommended for best performance. Fewer pictures can be taken with AA batteries (□ 396). The capacity of AA batteries drops sharply at temperatures below 20 °C (68 °F) and varies with make and storage conditions; in some cases, batteries may cease to function before their expiry date. Some AA batteries can not be used; due to their performance characteristics and limited capacity, alkaline and nickel-manganese batteries should only be used if no alternative is available and then only at warmer temperatures. The camera shows the level of AA batteries as follows:

Control panel	Viewfinder	Description
	—	Batteries fully charged.
		Low battery. Ready fresh batteries.
 (blinks)	 (blinks)	Shutter release disabled. Change batteries.

Battery level for EN-EL3e, EN-EL4a, or EN-EL4 rechargeable Li-ion batteries is displayed normally.

Choose whether the battery in the camera or the batteries in the battery pack are used first when an optional MB-D10 battery pack is attached.



A  icon is displayed in the camera control panel when the batteries in the MB-D10 are in use.

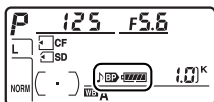



### The MB-D10 Battery Pack

The MB-D10 takes one EN-EL3e, EN-EL4a, or EN-EL4 rechargeable Li-ion battery or eight AA alkaline, Ni-MH, lithium, or nickel manganese batteries (an EN-EL3e is supplied with the camera; EN-EL4a, EN-EL4, and AA batteries are available separately). Higher frame rates are available with EN-EL4a, EN-EL4, and AA batteries ( 89); note, however, that in the case of AA batteries the frame rate will decrease as battery level drops.

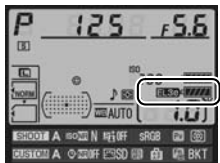
The information display shows the type of battery inserted in the MB-D10 as follows:



MB-D10 battery type display	Battery type
	EN-EL3e rechargeable Li-ion battery
	EN-EL4a or EN-EL4 rechargeable Li-ion battery
	AA batteries

## e: Bracketing/Flash

### e1: Flash Sync Speed

MENU button →  Custom Settings menu

This option controls flash sync speed.

Option	Description
<b>1/320 s (Auto FP)</b>	Use auto FP high-speed sync with SB-900, SB-800, SB-600, and SB-R200 flash units. If other flash units are used, shutter speed is set to $1/320$ s. When the camera shows a shutter speed of $1/320$ s in exposure mode <b>P</b> or <b>A</b> , auto FP high-speed sync will be activated if the actual shutter speed is faster than $1/320$ s.
<b>1/250 s (Auto FP)</b>	Use auto FP high-speed sync with SB-900, SB-800, SB-600, and SB-R200 flash units. If other flash units are used, shutter speed is set to $1/250$ s. When the camera shows a shutter speed of $1/250$ s in exposure mode <b>P</b> or <b>A</b> , auto FP high-speed sync will be activated if the actual shutter speed is faster than $1/250$ s.
<b>1/250 s–1/60 s</b>	Flash sync speed set to selected value.

#### **Fixing Shutter Speed at the Flash Sync Speed Limit**

To fix shutter speed at the sync speed limit in shutter-priority auto or manual exposure modes, select the next shutter speed after the slowest possible shutter speed (30 s or bulb). An X (flash sync indicator) will be displayed in the control panel and viewfinder.

#### **Auto FP High-Speed Sync**

Allows the flash to be used at the highest shutter speed supported by the camera, making it possible to choose the maximum aperture for reduced depth of field even when the subject is backlit in bright sunlight. The information display flash mode indicator shows “FP” when auto FP high-speed sync is active.



## Flash Control at 1/320 s (Auto FP)

When **1/320 s (Auto FP)** is selected for Custom Setting e1 (**Flash sync speed**,  281), the built-in flash can be used at shutter speeds as fast as 1/320 s, while optional SB-900, SB-800, SB-600, and SB-R200 flash units can be used at any shutter speed (Auto FP High-Speed Sync).

Flash sync speed	1/320 s (Auto FP)		1/250 s (Auto FP)		1/250 s	
	Built-in flash	Optional flash unit	Built-in flash	Optional flash unit	Built-in flash	Optional flash unit
1/8,000–1/320 s	—	Auto FP	—	Auto FP	—	—
1/320–1/250 s	Flash sync *		—	Auto FP	—	—
1/250–30 s	Flash sync					

\* Flash range drops as shutter speed increases. Flash range will nevertheless be greater than that obtained at the same speeds with Auto FP.

### The Flash-Ready Indicator

When the flash fires at full power, the flash-indicator in the camera viewfinder will blink to warn that the resulting photograph may be underexposed. Note that the flash-ready indicators on optional flash units will not display this warning when **1/320 s (Auto FP)** is selected.

## e2: Flash Shutter Speed

MENU button →  Custom Settings menu

This option determines the slowest shutter speed available when using front- or rear-curtain sync or red-eye reduction in programmed auto or aperture-priority auto exposure modes (regardless of the setting chosen, shutter speeds can be as slow as 30 s in shutter-priority auto and manual exposure modes or at flash settings of slow sync, slow rear-curtain sync, or red-eye reduction with slow sync). Options range from 1/60 s (**1/60 s**) to 30 s (**30 s**).





Choose the flash mode for the built-in flash.

Option	Description
TTL	Flash output is adjusted automatically in response to shooting conditions.
M	Choose the flash level ( 284).
RPT	The flash fires repeatedly while the shutter is open, producing a strobe-light effect ( 284).
C	Use the built-in flash as a master flash controlling one or more remote optional flash units ( 285).

### Flash Control Mode

The flash control mode for the built-in flash is shown in the information display.

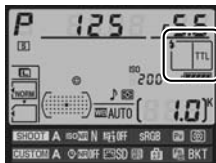

### “Manual” and “Repeating Flash”

icons blink in the control panel and viewfinder when these options are selected.

### The SB-400

When an optional SB-400 flash unit is attached and turned on, Custom Setting e3 changes to **Optional flash**, allowing the flash control mode for the SB-400 to be selected from **TTL** and **Manual** (**Repeating flash** and **Commander mode** options are not available).

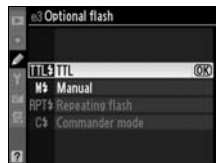

## Manual

Choose a flash level between **Full** and **1/128** ( $1/128$  of full power). At full power, the built-in flash has a Guide Number of 17/56 (m/ft., ISO 200, 20°C/68°F).

## Repeating Flash

The flash fires repeatedly while the shutter is open, producing a strobe-light effect. Press ◀ or ▶ to highlight the following options, ▲ or ▼ to change.



Option	Description
<b>Output</b>	Choose flash output (expressed as a fraction of full power).
<b>Times</b>	Choose the number of times the flash fires at the selected output. Note that depending on shutter speed and the option selected for <b>Frequency</b> , the actual number of flashes may be less than selected.
<b>Frequency</b>	Choose how often the flash fires per second.

### “Times”

The options available for **Times** are determined by flash output.

Output	Options available for Times
1/4	2
1/8	2–5
1/16	2–10
1/32	2–10, 15
1/64	2–10, 15, 20, 25
1/128	2–10, 15, 20, 25, 30, 35

## Commander Mode

Use the built-in flash as a master flash controlling one or more remote optional SB-900, SB-800, SB-600, or SB-R200 flash units in up to two groups (A and B) using advanced wireless lighting.

Selecting this option displays the menu shown at right. Press ◀ or ▶ to highlight the following options, ▲ or ▼ to change.



Option	Description
<b>Built-in flash</b>	Choose a flash mode for the built-in flash (commander flash).
TTL	i-TTL mode. Choose flash compensation from values between +3.0 and -3.0 EV in increments of 1/3 EV.
M	Choose the flash level from values between <b>1/1</b> and <b>1/128</b> (1/128 of full power).
--	The built-in flash does not fire, but the AF-assist illuminator lights. The built-in flash must be raised so that it can emit monitor pre-flashes.
<b>Group A</b>	Choose a flash mode for all flash units in group A.
TTL	i-TTL mode. Choose flash compensation from values between +3.0 and -3.0 EV in increments of 1/3 EV.
AA	Auto aperture (available only with SB-900 and SB-800 flash units). Choose flash compensation from values between +3.0 and -3.0 EV in increments of 1/3 EV.
M	Choose the flash level from values between <b>1/1</b> and <b>1/128</b> (1/128 of full power).
--	The flash units in this group do not fire.
<b>Group B</b>	Choose a flash mode for all flash units in group B. The options available are the same as those listed for <b>Group A</b> , above.
<b>Channel</b>	Choose from channels 1–4. All flash units in both groups must be set to the same channel.



Follow the steps below to take photographs in commander mode.

## 1 Adjust settings for the built-in flash.

Choose the flash control mode and output level for the built-in flash. Note that output level can not be adjusted in -- mode.



## 2 Adjust settings for group A.

Choose the flash control mode and output level for the flash units in group A.



## 3 Adjust settings for group B.

Choose the flash control mode and output level for the flash units in group B.



## 4 Select the channel.



## 5 Press **OK**.



---

## 6 Compose the shot.

Compose the shot and arrange the flash units as shown below. Note that the maximum distance at which the remote flash units can be placed may vary with shooting conditions.

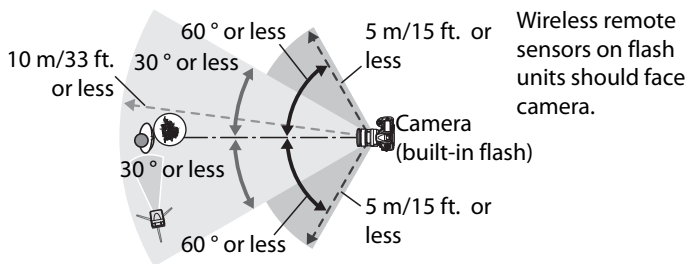

---

## 7 Set the remote flash units to the selected channel.

Turn all the remote flash units on and set them to the channel selected in Step 4. See the flash unit instruction manuals for details.

---

## 8 Raise the built-in flash.

Press the flash pop-up button to raise the built-in flash. Note that even if -- is selected for **Built-in flash > Mode**, the built-in flash must be raised so that monitor preflashes will be emitted.

---

## 9 Frame the photograph, focus, and shoot.



After confirming that the camera flash-ready light and the flash-ready lights for all other flash units are lit, frame the photograph, focus, and shoot. FV lock (☞ 178) can be used if desired.



### **The Flash Sync Mode Display**

 does not appear in the control panel flash sync mode display when -- is selected for **Built-in flash > Mode**.

### **Flash Compensation**

The flash compensation value selected with the  (⚡) button and sub-command dial is added to the flash compensation values selected for the built-in flash, group A, and group B in the **Commander mode** menu. A  icon is displayed in the control panel and viewfinder when a flash compensation value other than  $\pm 0$  is selected for **Built-in flash > TTL**. The  icon flashes when the built-in flash is in mode **M**.

### **Commander Mode**

Position the sensor windows on the remote flash units to pick up the monitor preflashes from the built-in flash (particular care is required when not using a tripod). Be sure that direct light or strong reflections from the remote flash units do not enter the camera lens (in TTL mode) or the photocells on the remote flash units (AA mode), as this may interfere with exposure. To prevent timing flashes emitted by the built-in flash from appearing in photographs taken at short range, choose low ISO sensitivities or small apertures (large f-numbers) or use an optional SG-3IR infrared panel for the built-in flash. An SG-3IR is required for best results with rear-curtain sync, which produces brighter timing flashes. After positioning the remote flash units, take a test shot and view the results in the camera monitor.

Although there is no limit on the number of remote flash units that may be used, the practical maximum is three. With more than this number, the light emitted by the remote flash units will interfere with performance.



## e4: Modeling Flash

MENU button →  Custom Settings menu

If **On** is selected when the camera is being used with the built-in flash or an optional SB-900, SB-800, SB-600, or SB-R200 flash unit, a modeling flash will be emitted when the camera depth-of-field preview button is pressed (📖 105). No modeling flash is emitted if **Off** is selected.

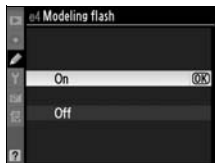

## e5: Auto Bracketing Set

MENU button →  Custom Settings menu





Choose the setting or settings bracketed when auto bracketing (📖 120) is in effect. Choose **AE & flash** (AE📷) to perform both exposure and flash-level bracketing, **AE only** (AE) to bracket only exposure, **Flash only** (📷) to perform only flash-level bracketing, **WB bracketing** (WB) to perform white-balance bracketing (📖 125), or **ADL bracketing** to perform bracketing using Active D-Lighting (📖 129). Note that white balance bracketing is not available at image quality settings of NEF (RAW) or NEF (RAW) + JPEG.



## e6: Auto Bracketing (Mode M)

MENU button →  Custom Settings menu

This option determines which settings are affected when **AE & flash** or **AE only** is selected for Custom Setting e5 in manual exposure mode.

Option	Description
 <b>Flash/speed</b>	Camera varies shutter speed (Custom Setting e5 set to <b>AE only</b> ) or shutter speed and flash level (Custom Setting e5 set to <b>AE &amp; flash</b> ).
 <b>Flash/speed/aperture</b>	Camera varies shutter speed and aperture (Custom Setting e5 set to <b>AE only</b> ) or shutter speed, aperture, and flash level (Custom Setting e5 set to <b>AE &amp; flash</b> ).
 <b>Flash/aperture</b>	Camera varies aperture (Custom Setting e5 set to <b>AE only</b> ) or aperture and flash level (Custom Setting e5 set to <b>AE &amp; flash</b> ).
 <b>Flash only</b>	Camera varies flash level only (Custom Setting e5 set to <b>AE &amp; flash</b> ).

Flash bracketing is performed only with i-TTL or AA flash control. If a setting other than **Flash only** is selected and the flash is not used, ISO sensitivity will be fixed at the value for the first shot, regardless of the setting selected for ISO sensitivity auto control (📖 98).

## e7: Bracketing Order

MENU button →  Custom Settings menu

At the default setting of **MTR>under>over** (📄), exposure, flash, and white balance bracketing are performed in the order described on pages 122 and 126. If **Under>MTR>over** (→+) is selected, shooting will proceed in order from the lowest to the highest value. This setting has no effect on ADL bracketing.









# f: Controls

## f1: Switch

MENU button →  Custom Settings menu

Choose what happens when the power switch is rotated to .

Option	Description
 LCD backlight (  )	Control panel backlight illuminates for 6 s.
  and information display	Control panel backlight illuminates and shooting information is displayed in monitor.

## f2: Multi Selector Center Button



MENU button →  Custom Settings menu



This option determines the role assigned to the center of the multi selector in shooting and playback modes (regardless of the option selected, pressing the center of the multi selector when a movie is displayed full frame starts movie playback).

### ■ Shooting Mode

Option	Role assigned to center of multi selector
RESET Select center focus point	Select center focus point.
 Highlight active focus point	Highlight active focus point.
Not used	None.

### ■ Playback Mode

Option	Role assigned to center of multi selector
 Thumbnail on/off	Toggle between full-frame and thumbnail playback.
 View histograms	In both full-frame and thumbnail playback, a histogram is displayed while the center of the multi selector is pressed.
 Zoom on/off	Toggle between full-frame or thumbnail playback and playback zoom. Choose the initial zoom setting from <b>Low magnification</b> , <b>Medium magnification</b> , and <b>High magnification</b> . The zoom display will center on the active focus point.

Option	Role assigned to center of multi selector
 <b>Choose slot and folder</b>	Display card slot selection dialog; highlight slot and press <b>▶</b> to display list of folders. Highlight folder and press <b>Ⓚ</b> to select folder for playback. Only folders currently selected for playback (  245) are displayed.

### f3: Multi Selector

MENU button →  Custom Settings menu

If **Reset meter-off delay** is selected, operating the multi selector when the exposure meters are off ( 39) will activate the exposure meters. If **Do nothing** is selected, the exposure meters will not be activated when the multi selector is pressed.



### f4: Photo Info/Playback

MENU button →  Custom Settings menu

If **Info▲▼/Playback◀▶** is selected, pressing **▲** or **▼** in full-frame playback changes the photo information displayed, while pressing **◀** or **▶** displays additional images. To reverse the role of the multi selector buttons so that pressing **▲** or **▼** displays additional images and pressing **◀** or **▶** changes the photo information displayed, select **Info◀▶/Playback▲▼**. This setting also applies to the multi selector on the optional MB-D10 battery pack.



### f5: Assign Fn Button





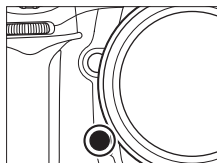



MENU button →  Custom Settings menu

Choose the role played by the **Fn** button, either by itself (**Fn button press**) or when used in combination with the command dials (**Fn button + dials**).











## ■ ■ Fn Button Press

Selecting **Fn button press** for Custom Setting f5 displays the following options:

Option	Description
 <b>Preview*</b>	Press the <b>Fn</b> button to preview depth of field (□ 105).
 <b>FV lock*</b>	Press the <b>Fn</b> button to lock flash value (built-in flash and SB-900, SB-800, SB-600, SB-400, and SB-R200 flash units only, □ 178). Press again to cancel FV lock.
 <b>AE/AF lock</b>	Focus and exposure lock while the <b>Fn</b> button is pressed.
 <b>AE lock only</b>	Exposure locks while the <b>Fn</b> button is pressed.
 <b>AE lock (Reset on release)*</b>	Exposure locks when the <b>Fn</b> button is pressed, and remains locked until the button is pressed a second time, the shutter is released, or the exposure meters turn off.
 <b>AE lock (Hold)*</b>	Exposure locks when the <b>Fn</b> button is pressed, and remains locked until the button is pressed a second time or the exposure meters turn off.
 <b>AF lock only</b>	Focus locks while the <b>Fn</b> button is pressed.
 <b>Flash off</b>	The flash will not fire in photos taken while the <b>Fn</b> button is pressed.
<b>BKT</b> <b>Bracketing burst</b>	If the <b>Fn</b> button is pressed while exposure or flash bracketing is active in single frame or quiet shutter-release mode, all shots in the current bracketing program will be taken each time the shutter-release button is pressed. If white balance bracketing is active or continuous release mode (mode <b>CH</b> or <b>CL</b> ) is selected, the camera will repeat the bracketing burst while the shutter-release button is held down (in single frame release mode, white balance bracketing will be repeated at the frame rate for <b>CH</b> release mode).
 <b>Matrix metering</b>	Matrix metering is activated while the <b>Fn</b> button is pressed.





Option	Description
 <b>Center-weighted metering</b>	Center-weighted metering is activated while the <b>Fn</b> button is pressed.
 <b>Spot metering</b>	Spot metering is activated while the <b>Fn</b> button is pressed.
 <b>Playback *</b>	<b>Fn</b> button performs same function as  button. Select when using a telephoto lens or in other circumstances in which it is difficult to operate the  button with your left hand.
 <b>Access top item in MY MENU *</b>	Press the <b>Fn</b> button to jump to the top item in “MY MENU.” Select this option for quick access to a frequently-used menu item.
 <b>+NEF (RAW) *</b>	If image quality is set to <b>JPEG fine</b> , <b>JPEG normal</b> , or <b>JPEG basic</b> , “RAW” will be displayed in the control panel and an NEF (RAW) copy will be recorded with the next picture taken after the <b>Fn</b> button is pressed (to record NEF/RAW copies with a series of photographs, keep the shutter-release button pressed halfway between shots). To exit without recording an NEF (RAW) copy, press the <b>Fn</b> button again.
<b>None</b>	No operation is performed when the <b>Fn</b> button is pressed.

\* This option can not be used in combination with **Fn button + dials** ( 295). Selecting this option displays a message and sets **Fn button + dials** to **None**. If another option is selected for **Fn button + dials** while this setting is active, **Fn button press** will be set to **None**.



## ■ ■ Fn button + dials



Selecting **Fn button + dials** for Custom Setting f5 displays the following options:

Option	Description
 <b>1 step spd/aperture</b>	If the <b>Fn</b> button is pressed when the command dials are rotated, changes to shutter speed (exposure modes <b>S</b> and <b>M</b> ) and aperture (exposure modes <b>A</b> and <b>M</b> ) are made in increments of 1 EV, regardless of the option selected for Custom Setting b2 ( <b>EV steps for exposure cntrl.</b> , □ 270).
<b>Non-CPU</b> <b>Choose non-CPU lens number</b>	Press the <b>Fn</b> button and rotate a command dial to choose a lens number specified using the <b>Non-CPU lens data</b> option.
<b>BKT</b> <b>Auto bracketing</b>	Press the <b>Fn</b> button and rotate the main command dial to choose the number of shots in the bracketing program. Press the <b>Fn</b> button and rotate the sub-command dial to select bracketing increment.
 <b>Dynamic AF area</b>	If continuous-servo AF (focus mode <b>C</b> ; □ 74) is selected when dynamic-area AF (  ) is chosen for AF-area mode (□ 76), the number of focus points can be selected by pressing the <b>Fn</b> button and rotating either of the command dials (□ 264).
<b>None</b>	No operation is performed when the command dials are rotated while the <b>Fn</b> button is pressed.



## f6: Assign Preview Button

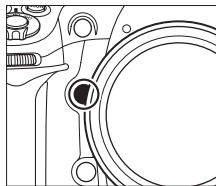

MENU button →  Custom Settings menu

Choose the role played by the depth-of-field preview button, either by itself (**Preview button press**) or when used in combination with the command dials (**Preview + command dials**). The options available are the same as for **Fn button press** ( 293) and **Fn button + dials** ( 295), except that the default option for **Preview button press** is **Preview** and the default setting for **Preview + command dials** is **None**.



## f7: Assign AE-L/AF-L Button

MENU button →  Custom Settings menu

Choose the role played by the **AE-L/AF-L** button, either by itself (**AE-L/AF-L button press**) or when used in combination with the command dials (**AE-L/AF-L + command dials**). The options available for **AE-L/AF-L button press** are the same as for **Fn button press** ( 293), except that **AE-L/AF-L button press** defaults to **AE/AF lock** and has an additional **AF-ON** option (if this option is selected, pressing the **AE-L/AF-L** button has the same effect as pressing the **AF-ON** button to initiate autofocus; this option can not be used in combination with **AE-L/AF-L + command dials**). The options available for **AE-L/AF-L + command dials** are the same as for **Fn button + dials** ( 295), except that **AE-L/AF-L + command dials** defaults to **None** and lacks **1 step spd/aperture** option.

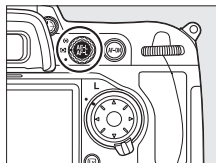

This option controls the operation of the main and sub-command dials.

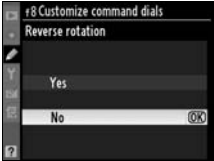
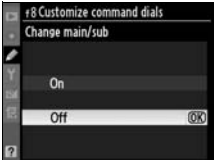

Option	Description
<b>Reverse rotation</b>	<p>Controls the direction of the command dials. Choose <b>No</b> for normal command dial operation, <b>Yes</b> to reverse the rotation of the command dials. This setting also applies to the command dials for the MB-D10.</p> 
<b>Change main/sub</b>	<p>If <b>Off</b> is selected, the main command dial controls shutter speed and the sub-command dial controls aperture. If <b>On</b> is selected, the main command dial will control aperture and the sub-command dial shutter speed. This setting also applies to the command dials for the MB-D10.</p> 
<b>Aperture setting</b>	<p>If <b>Sub-command dial</b> is selected, aperture can only be adjusted with the sub-command dial (or with the main command dial if <b>On</b> is selected for <b>Change main/sub</b>). If <b>Aperture ring</b> is selected, aperture can only be adjusted with the lens aperture ring and the camera aperture display will show aperture in increments of 1 EV (aperture for type G lenses is still set using the sub-command dial). Live view is not available when <b>Aperture ring</b> is selected and a CPU lens with an aperture ring is attached. Note that regardless of the setting chosen, the aperture ring must be used to adjust aperture when a non-CPU lens is attached.</p>



Option	Description
<b>Menus and playback</b>	If <b>Off</b> is selected, the multi selector is used to choose the picture displayed during full-frame playback, highlight thumbnails, and navigate menus. If <b>On</b> is selected, the main command dial can be used to choose the picture displayed during full-frame playback, move the cursor left or right during thumbnail playback, and move the menu highlight bar up or down. The sub-command dial is used to display additional photo information in full-frame playback and to move the cursor up or down during thumbnail playback. While menus are displayed, rotating the sub-command dial right displays the sub-menu for the selected option, while rotating it left displays the previous menu. To make a selection, press ►, the center of the multi selector, or Ⓞ.

## f9: Release Button to Use Dial

MENU button →  Custom Settings menu

Selecting **Yes** allows adjustments that are normally made by holding the **MODE**, , , **ISO**, **QUAL**, or **WB** button and rotating a command dial to be made by rotating the command dial after the button is released (this also applies to the button to which bracketing is currently assigned;  295). Setting ends when any of the affected buttons is pressed again or the shutter-release button is pressed halfway. Except when **No limit** is selected for Custom Setting c2 **Auto meter-off delay** or an optional EH-5a or EH-5 AC adapter is used, setting will also end when the exposure meters turn off.







## f10: No Memory Card?

MENU button →  Custom Settings menu

Selecting **Enable release** allows the shutter to be released when no memory card is inserted, although no pictures will be recorded (they will however be displayed in the monitor in demo mode). If **Release locked** is selected, the shutter-release button is only enabled when a memory card is inserted in the camera. Note that when photographs are being captured to a computer using Camera Control Pro 2 (available separately), photographs are not recorded to the camera memory card and the shutter will be enabled regardless of the setting chosen for this option.

## f11: Reverse Indicators

MENU button →  Custom Settings menu

At the default setting of  (+<sup>o</sup>-), the exposure indicators in the control panel, viewfinder and information display are displayed with positive values on the left and negative values on the right. Select  (-<sup>o</sup>+) to display negative values on the left and positive values on the right.



# Y The Setup Menu: *Camera Setup*

To display the setup menu, press MENU and select the Y (setup menu) tab.

## MENU button



Option	
<b>Format memory card</b>	301
<b>LCD brightness</b>	301
<b>Clean image sensor</b>	358
<b>Lock mirror up for cleaning</b> <sup>1</sup>	361
<b>Video mode</b>	301
<b>HDMI</b>	302
<b>Time zone and date</b>	302
<b>Language</b>	303
<b>Image comment</b>	303
<b>Auto image rotation</b>	304
<b>Image Dust Off ref photo</b>	305

Option	
<b>Battery info</b>	307
<b>Wireless transmitter</b>	227
<b>Image authentication</b>	308
<b>Copyright information</b>	309
<b>Save/load settings</b>	310
<b>GPS</b>	201
<b>Virtual horizon</b>	311
<b>Non-CPU lens data</b>	196
<b>AF fine tune</b>	312
<b>Eye-Fi upload</b> <sup>2</sup>	313
<b>Firmware version</b>	314

1 Not available when battery is low.

2 Only available when compatible Eye-Fi memory card is inserted (☐ 313).



## Format Memory Card

MENU button → Y Setup menu

To begin formatting, choose a memory card slot and select **Yes**. *Note that formatting permanently deletes all pictures and other data on the card in the selected slot.* Before formatting, be sure to make backup copies as required.



### During Formatting

*Do not turn the camera off or remove memory cards during formatting.*

### Two-Button Format

Memory cards can also be formatted by pressing the **FORMAT** (🗑️) and **MODE** buttons for more than two seconds (📖 34).

## LCD Brightness

MENU button → Y Setup menu

Press ▲ or ▼ to choose monitor brightness. Choose higher values for increased brightness, lower values for reduced brightness.

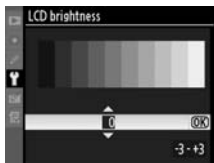

## Video Mode

MENU button → Y Setup menu

When connecting the camera to a television or VCR via the video connector, be sure the camera video mode matches the device video standard (NTSC or PAL).



The camera is equipped with an HDMI (**H**igh-**D**efinition **M**ultimedia **I**nterface) connector, allowing pictures to be played back on high-definition televisions or monitors using a cable with a type C mini-pin connector (available separately from commercial suppliers). Before connecting the camera to high-definition device, choose the HDMI format from the options below.

Option	Description
AUTO <b>Auto</b>	The camera automatically selects the appropriate format.
480P <b>480p (progressive)</b>	640 × 480 (progressive) format
576P <b>576p (progressive)</b>	720 × 576 (progressive) format
720P <b>720p (progressive)</b>	1,280 × 720 (progressive) format
1080i <b>1080i (interlaced)</b>	1,920 × 1,080 (interlaced) format

The camera monitor turns off automatically when an HDMI device is connected.

## Time Zone and Date

Change time zones, set the camera clock, choose the date display order, and turn daylight saving time on or off.

Option	Description
<b>Time zone</b>	Choose a time zone. The camera clock is automatically set to the time in the new time zone.
<b>Date and time</b>	Set the camera clock (📅 29). If the clock is not set, a blinking ⌚ icon will appear in the control panel.
<b>Date format</b>	Choose the order in which the day, month, and year are displayed.
<b>Daylight saving time</b>	Turn daylight saving time on or off. The camera clock will automatically be advanced or set back one hour. The default setting is <b>Off</b> .



Choose a language for camera menus and messages. The following options are available.

Dk Dansk	Danish
De Deutsch	German
En English	English
Es Español	Spanish
Fi Suomi	Finnish
Fr Français	French
It Italiano	Italian
Nl Nederlands	Dutch
No Norsk	Norwegian

Pl Polski	Polish
Pt Português	Portuguese
Ru Русский	Russian
Sv Svenska	Swedish
繁 中文(繁體)	Traditional Chinese
简 中文(简体)	Simplified Chinese
日 日本語	Japanese
한 한글	Korean

## Image Comment

Add a comment to new photographs as they are taken. Comments can be viewed as metadata in ViewNX (supplied) or Capture NX 2 (available separately; □ 355). The comment is also visible on the third shooting data page in the photo information display (□ 213).

- **Done:** Save changes and return to the setup menu.
- **Input comment:** Input a comment as described on page 255. Comments can be up to 36 characters long.
- **Attach comment:** Select this option to attach the comment to all subsequent photographs. **Attach comment** can be turned on and off by highlighting it and pressing ►.

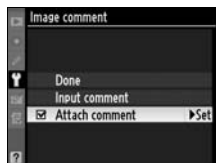

Photographs taken while **On** is selected contain information on camera orientation, allowing them to be rotated automatically during playback (☞ 204) or when viewed in ViewNX (supplied) or in Capture NX 2 (available separately; ☞ 355). The following orientations are recorded:



Landscape (wide)  
orientation



Camera rotated 90°  
clockwise



Camera rotated 90°  
counter-clockwise

Camera orientation is not recorded when **Off** is selected. Choose this option when panning or taking photographs with the lens pointing up or down.

#### **Rotate Tall**

To automatically rotate “tall” (portrait-orientation) photographs for display during playback, select **On** for the **Rotate tall** option in the playback menu (☞ 251). Note that because the camera itself is already in the appropriate orientation during shooting, images are not rotated automatically during image review (☞ 206).

Acquire reference data for the Image Dust Off option in Capture NX 2 (available separately; for more information, see the Capture NX 2 manual).

**Image Dust Off ref photo** is available only when a CPU lens is mounted on the camera. A lens with a focal length of at least 50 mm is recommended. When using a zoom lens, zoom all the way in.

## 1 Choose a start option.

Highlight one of the following options and press **OK**. To exit without acquiring image dust off data, press **MENU**.



- **Start:** The message shown at right will be displayed and “rEF” will appear in the viewfinder and control panel displays.
- **Clean sensor and then start:** Select this option to clean the image sensor before starting. The message shown at right will be displayed and “rEF” will appear in the viewfinder and control panel displays when cleaning is complete.

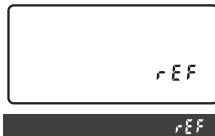

### Image Sensor Cleaning

Dust off reference data recorded before image sensor cleaning is performed can not be used with photographs taken after image sensor cleaning is performed. Select **Clean sensor and then start** only if the dust off reference data will not be used with existing photographs.



## 2 Frame a featureless white object in the viewfinder.

With the lens about ten centimeters (four inches) from a well-lit, featureless white object, frame the object so that it fills the viewfinder and then press the shutter-release button halfway.

In autofocus mode, focus will automatically be set to infinity; in manual focus mode, set focus to infinity manually.

## 3 Acquire dust off reference data.

Press the shutter-release button the rest of the way down to acquire Image Dust Off reference data. The monitor turns off when the shutter-release button is pressed.

If the reference object is too bright or too dark, the camera may be unable to acquire Image Dust Off reference data and the message shown at right will be displayed. Choose another reference object and repeat the process from step 1.



### Image Dust Off Reference Data

The same reference data can be used for photographs taken with different lenses or at different apertures. Reference images can not be viewed using computer imaging software. A grid pattern is displayed when reference images are viewed on the camera.





View information on the battery currently inserted in the camera.



Item	Description
<b>Bat. meter</b>	The current battery level expressed as a percentage.
<b>Pic. meter</b>	The number of times the shutter has been released with the current battery since the battery was last charged. Note that the camera may sometimes release the shutter without recording a photograph, for example when measuring preset white balance.
<b>Calibration</b>	<p>This item is displayed only when the camera is powered by an optional MB-D10 battery pack equipped with an EN-EL4a or EN-EL4 battery (available separately).</p> <ul style="list-style-type: none"> <li>☀CAL: Due to repeated use and recharging, calibration is required to ensure that battery level can be measured accurately; recalibrate battery before charging.</li> <li>—: Calibration not required.</li> </ul>
<b>Battery age</b>	<p>A five-level display showing battery age. 0 (NEW) indicates that battery performance is unimpaired, 4 (🔋) that the battery has reached the end of its charging life and should be replaced. Note that batteries charged at temperatures under about 5 °C (41 °F) may show a temporary drop in charging life; the battery age display will however return to normal once the battery has been recharged at a temperature of about 20 °C (68 °F) or higher.</p>

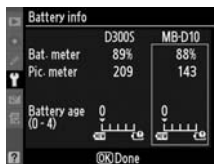

## The MB-D10 Battery Pack

The display for the MB-D10 battery pack is shown at right. The picture meter and battery age are not displayed when the battery pack contains AA batteries.



This option is used to adjust settings for connection to a wireless network, using an optional WT-4 wireless transmitter. See “Connections: Wireless and Ethernet Networks” (□ 227).

## Image Authentication

Choose  **On** to embed image authentication information in new photographs as they are taken, allowing alterations to be detected using Nikon’s optional Image Authentication software. Image authentication information can not be embedded in existing photographs. Photographs taken with image authentication on are marked with a  icon on the file information and overview pages of the photo information display (□ 208, 215).

### **Camera Control Pro 2**

Image authentication information is not embedded in TIFF (RGB) photographs recorded directly to a computer using Camera Control Pro 2 (available separately).

### **Copies**

Image authentication information is not embedded in copies created using the options in the retouch menu (□ 315).

Add copyright information to new photographs as they are taken. Copyright information is visible on the fourth shooting data page in the photo information display (☐ 214) and can be viewed as metadata in ViewNX (supplied) or in Capture NX 2 (available separately; ☐ 355).

- **Done:** Save changes and return to the setup menu.
- **Artist:** Enter a photographer name as described on page 255. Photographer names can be up to 36 characters long.
- **Copyright:** Enter the name of the copyright holder as described on page 255. Copyright holder names can be up to 54 characters long.
- **Attach copyright information:** Select this option to attach copyright information to all subsequent photographs. **Attach copyright information** can be turned on and off by highlighting it and pressing ►.

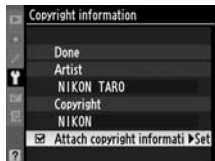

### ☑ Copyright Information

To prevent unauthorized use of the artist or copyright holder names, make sure that **Attach copyright information** is not selected and that the **Artist** and **Copyright** fields are blank before lending or transferring the camera to another person. Nikon does not accept liability for any damages or disputes arising from the use of the **Copyright information** option.

Select **Save settings** to save the following settings to the memory card, or to the memory card in the primary card slot if two memory cards are inserted (if the memory card is full, an error will be displayed; □ 381).

Menu	Option
Playback	Display mode
	Image review
	After delete
	Rotate tall
Shooting (all banks)	Shooting menu bank
	File naming
	Image quality
	Image size
	JPEG compression
	NEF (RAW) recording
	White balance (with fine tuning and presets d-0–d-4)
	Set Picture Control
	Color space
	Active D-Lighting
	Long exp. NR
	High ISO NR
	ISO sensitivity settings
	Live view mode
Movie settings	
Custom settings (all banks)	All Custom Settings except <b>Reset custom settings</b>



Menu	Option
Setup	Clean image sensor
	Video mode
	HDMI
	Time zone and date (excepting date and time)
	Language
	Image comment
	Auto image rotation
	Image authentication
	Copyright information
	GPS
	Non-CPU lens data
My Menu/ Recent Settings	All My Menu items
	All recent settings
	Choose tab

Settings saved using the D300S can be restored by selecting **Load settings**. Note that **Save/load settings** is only available when a memory card is inserted in the camera, and that the **Load settings** option is only available if the card contains saved settings.

#### **Saved Settings**

Settings are saved in a file named NCSETUP5. The camera will not be able to load settings if the file name is changed.

## Virtual Horizon

MENU button →  Setup menu

Display a virtual horizon based on information from the camera image sensor. The reference line is displayed in green when the camera is level.

#### **Tilting the Camera**



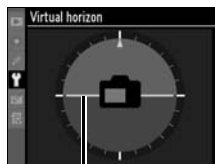

The virtual horizon display is not accurate when the camera is tilted at a sharp angle forward or back. If the camera is unable to measure tilt, the virtual horizon will not be displayed.



Reference line

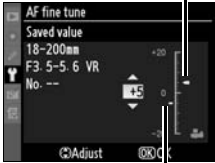

Fine-tune focus for up to 12 lens types. AF tuning is not recommended in most situations and may interfere with normal focus; use only when required.

Option	Description	
<b>AF fine tune (On/Off)</b>	<ul style="list-style-type: none"> <li>• <b>On:</b> Turn AF tuning on.</li> <li>• <b>Off:</b> Turn AF tuning off.</li> </ul>	
<b>Saved value</b>	<p>Tune AF for the current lens (CPU lenses only). Press ▲ or ▼ to choose a value between +20 and -20. Values for up to 12 lens types can be stored. Only one value can be stored for each type of lens.</p>	<p>Move focal point away from camera.      Current value</p> 
<b>Default</b>	<p>Choose the AF tuning value used when no previously saved value exists for the current lens (CPU lenses only).</p>	<p>Move focal point toward camera.      Previous value</p>
<b>List saved values</b>	<p>List previously saved AF tuning values. If a value exists for the current lens, it will be shown with a ■ icon. To delete a lens from the list, highlight the desired lens and press . To change a lens identifier (for example, to choose an identifier that is the same as the last two digits of the lens serial number to distinguish it from other lenses of the same type in light of the fact that <b>Saved value</b> can be used with only one lens of each type), highlight the desired lens and press ►.</p> <p>The menu shown at right will be displayed; press ▲ or ▼ to choose an identifier and press  to save changes and exit.</p> 	

### ✓ AF Tuning

The camera may be unable to focus at minimum range or at infinity when AF tuning is applied.

### ✓ Live View (Tripod) Mode

Tuning is not applied to contrast-detect autofocus when **Tripod** is selected in live view mode (□ 49).

### ✎ Saved Value

Only one value can be stored for each type of lens. If a teleconverter is used, separate values can be stored for each combination of lens and teleconverter.







## Eye-Fi Upload

MENU button → Y Setup menu

This option is displayed only when an Eye-Fi memory card (available separately from third-party suppliers) is inserted in the camera. Choose **Enable** to upload photographs to a preselected destination. Note that pictures will not be uploaded if signal strength is insufficient.

Observe all local laws concerning wireless devices and choose **Disable** where wireless devices are prohibited.

When an Eye-Fi card is inserted, its status is indicated by an icon in the information display:

-  Eye-Fi upload disabled.
-  Eye-Fi upload enabled but no pictures available for upload.
-  (static): Eye-Fi upload enabled; waiting to begin upload.
-  (animated): Eye-Fi upload enabled; uploading data.
-  Error. — camera can not control Eye-Fi card. If a blinking  appears in the control panel or viewfinder, refer to page 382; if this indicator is not displayed, pictures can be taken normally but you may be unable to change Eye-Fi settings.

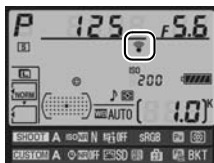

### **Eye-Fi Cards**

For information on errors involving Eye-Fi cards, see the manual provided with the Eye-Fi card, and direct any inquiries to the manufacturer. The camera can be used to turn Eye-Fi cards on and off, but may not support other Eye-Fi functions.

### **Supported Eye-Fi Cards**

As of April 2009, the following 2 GB Eye-Fi cards can be used: Eye-Fi Home, Eye-Fi Share, and Eye-Fi Explore. Eye-Fi cards are for use only in the country of purchase. Be sure the Eye-Fi card firmware has been updated to the latest version.

## **Firmware Version**

MENU button →  Setup menu

View the current camera firmware version.

















# The Retouch Menu: *Creating Retouched Copies*

To display the retouch menu, press **MENU** and select the  (retouch menu) tab.

## MENU button



The options in the retouch menu are used to create trimmed, or retouched copies of existing pictures. The retouch menu is only displayed when a memory card containing photographs is inserted in the camera.

Option	
 <b>D-Lighting</b>	319
 <b>Red-eye correction</b>	320
 <b>Trim</b>	321
 <b>Monochrome</b>	322
 <b>Filter effects</b>	322
 <b>Color balance</b>	323
 <b>Image overlay<sup>1</sup></b>	324
 <b>NEF (RAW) processing</b>	327
 <b>Resize</b>	329
 <b>Edit movie</b>	64
 <b>Side-by-side comparison<sup>2</sup></b>	331

Options that can not be applied to current image are grayed out and unavailable.

1 Can only be selected by pressing **MENU** and selecting  tab.

2 Only available if  is pressed in full-frame playback when a retouched image or original is displayed.



# Creating Retouched Copies

To create a retouched copy:

## 1 Choose a picture.

Display the desired picture in full-frame playback (📖 204).



### Retouch

The camera may not be able to display or retouch images created with other devices.

## 2 Display the retouch menu.

Press **OK** to display the retouch menu.



### See Also

See page 227 for information on using the **OK** button with the WT-4 wireless transmitter.

## 3 Display retouch options.

Highlight the desired item in the retouch menu and press **OK**.





## 4 Select retouch options.

For more information, see the section for the selected item. To return to full-frame playback without creating a retouched copy, press .

### **Monitor off Delay**

The monitor will turn off automatically if no operations are performed for 20 s. The delay can be adjusted with Custom Setting c4 (**Monitor off delay**).

## 5 Create a retouched copy.

Press  to create a retouched copy. Retouched copies are indicated by a  icon.



### **Creating Retouched Copies from the Retouch Menu**

The photographs to be retouched can also be selected from the retouch menu.

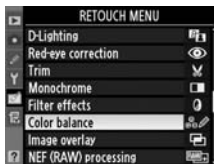

*Highlight an option and press .*



*Highlight a picture and press .*



*Create retouched copy of selected picture.*



### **Retouching Copies**

Most options can be applied to copies created using other retouch options, although with the exceptions of **Image overlay** and **Edit movie** each option can only be applied once (note that multiple edits may result in loss of detail). Options that can not be applied to the current image are grayed out and unavailable.

### **Image Quality**

Except in the case of copies created with **Trim**, **Image overlay**, **NEF (RAW) processing**, and **Resize**, copies created from JPEG images are the same size and quality as the original, copies created from NEF (RAW) photos are saved as large fine-quality JPEG images, and copies created from TIFF (RGB) photos are saved as fine-quality JPEG images of the same size as the original. Size-priority compression is used when copies are saved in JPEG format.



D-lighting brightens shadows, making it ideal for dark or backlit photographs.



Before

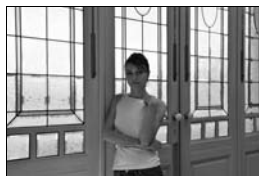









After

Press ▲ or ▼ to choose the amount of correction performed. The effect can be previewed in the edit display. Press  to copy the photograph.



This option is used to correct “red-eye” caused by the flash, and is available only with photographs taken using the flash. The photograph selected for red-eye correction is previewed as shown at right. Confirm the effects of red-eye correction and create a copy as described in the following table. Note that red-eye correction may not always produce the expected results and may in very rare circumstances be applied to portions of the image that are not affected by red-eye; check the preview thoroughly before proceeding.











To	Use	Description
Zoom in		Press  button to zoom in,  button to zoom out. While photo is zoomed in, use multi selector to view areas of image not visible in monitor. Keep multi selector pressed to scroll rapidly to other areas of frame. Navigation window is displayed when zoom buttons or multi selector is pressed; area currently visible in monitor is indicated by yellow border. Press  to cancel zoom.
Zoom out		
View other areas of image		
Cancel zoom		
Create copy		If the camera detects red-eye in the selected photograph, a copy will be created that has been processed to reduce its effects. No copy will be created if the camera is unable to detect red-eye.



Create a cropped copy of the selected photograph. The selected photograph is displayed with the selected crop shown in yellow; create a cropped copy as described in the following table.



To	Use	Description
Reduce size of crop		Press the  button to reduce the size of the crop.
Increase size of crop		Press the  button to increase the size of the crop.
Change crop aspect ratio		Rotate the main command dial to switch between aspect ratios of 3 : 2, 4 : 3, 5 : 4, 1 : 1, and 16 : 9.
Move crop		Use multi selector to move the crop to another area of the image.
Preview crop		Press center of multi selector to preview cropped image.
Create copy		Save the current crop as a separate file.

### Trim: Image Quality and Size

Copies created from NEF (RAW), NEF (RAW) + JPEG, or TIFF (RGB) photos have an image quality (□ 68) of JPEG fine; cropped copies created from JPEG photos have the same image quality as the original. The size of the copy varies with crop size and aspect ratio.

Aspect ratio	Possible sizes
3 : 2	3,424 × 2,280, 2,560 × 1,704, 1,920 × 1,280, 1,280 × 856, 960 × 640, 640 × 424
4 : 3	3,424 × 2,568, 2,560 × 1,920, 1,920 × 1,440, 1,280 × 960, 960 × 720, 640 × 480
5 : 4	3,216 × 2,568, 2,400 × 1,920, 1,808 × 1,440, 1,200 × 960, 896 × 720, 608 × 480
1 : 1	2,560 × 2,560, 1,920 × 1,920, 1,440 × 1,440, 960 × 960, 720 × 720, 480 × 480
16 : 9	3,424 × 1,920, 2,560 × 1,440, 1,920 × 1,080, 1,280 × 720, 960 × 536, 640 × 360

### Viewing Cropped Copies

Playback zoom may not be available when cropped copies are displayed.

## Monochrome

MENU button →  retouch menu

Copy photographs in **Black-and-white**, **Sepia**, or **Cyanotype** (blue and white monochrome).



Selecting **Sepia** or **Cyanotype** displays a preview of the selected image; press ▲ to increase color saturation, ▼ to decrease. Press **OK** to create a monochrome copy.

Increase saturation  
  
Decrease saturation

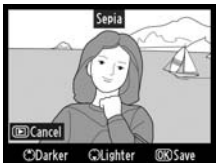

## Filter Effects

MENU button →  retouch menu

Choose from the following color filter effects. After adjusting filter effects as described below, press **OK** to copy the photograph.

Option	Description
<b>Skylight</b>	Creates the effect of a skylight filter, making the picture less blue. The effect can be previewed in the monitor as shown at right. 
<b>Warm filter</b>	Creates a copy with warm tone filter effects, giving the copy a "warm" red cast. The effect can be previewed in the monitor.





Use the multi selector to create a copy with modified color balance as shown below. The effect is displayed in the monitor together with red, green, and blue histograms (📖 210) giving the distribution of tones in the copy. Press to copy the photograph.

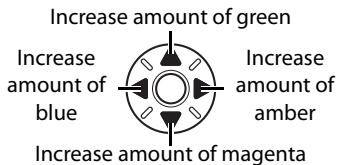

## Zoom

To zoom in on the image displayed in the monitor, press the button. The histogram will be updated to show data only for the portion of the image displayed in the monitor. While the image is zoomed in, press the button to toggle back and forth between color balance and zoom. When zoom is selected, you can zoom in and out with the and buttons and scroll the image with the multi selector.



Image overlay combines two existing NEF (RAW) photographs to create a single picture that is saved separately from the originals; the results, which make use of RAW data from the camera image sensor, are noticeably better than photographs combined in an imaging application. The new picture is saved at current image quality and size settings; before creating an overlay, set image quality and size (☐ 68, 71; all options are available). To create a NEF (RAW) copy, choose an image quality of **NEF (RAW)**.

## 1 Select Image overlay.

Highlight **Image overlay** in the retouch menu and press . The dialog shown at right will be displayed, with **Image 1** highlighted.





## 2 Display NEF (RAW) images.

Press . A picture selection dialog will be displayed.



## 3 Select a photograph.

Highlight the first photograph in the overlay. To view the highlighted photograph full frame, press and hold the  button (to view images in other locations, press  and select the desired card and folder as described on page 217). Press  to select the highlighted photograph and return to the preview display.



## 4 Select the second photograph.

The selected image will appear as **Image 1**. Press **▶** to highlight **Image 2** and repeat steps 2–3 to select the second photo.



## 5 Set gain.

Highlight **Image 1** or **Image 2** and optimize exposure for the overlay by pressing **▲** or **▼** to select the gain for image 1 from values between 0.1 and 2.0. Repeat for the second image. The default value is 1.0; selecting 0.5 cuts gain in half, while selecting 2.0 doubles gain. The effects of gain are visible in the **Preview** column.



## 6 Highlight the Preview column.

Press **◀** or **▶** to highlight the **Preview** column.

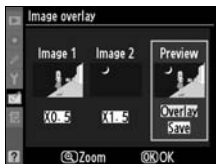

## 7 Preview the overlay.

Press **▲** or **▼** to highlight **Overlay** and press **OK** (to save the overlay without displaying a preview, highlight **Save** and press **OK**). To return to Step 5 and select new photos or adjust gain, press **☒**.



## 8 Save the overlay.

Press **OK** while the preview is displayed to save the overlay. After an overlay is created, the resulting image will be displayed full-frame in the monitor.



### Image Overlay

Only NEF (RAW) photographs created with the D300S can be selected for image overlay. Other images are not displayed in the selection screen. Only NEF (RAW) photographs with the same bit-depth can be combined.

The overlay has the same photo info (including date of recording, metering, shutter speed, aperture, exposure mode, exposure compensation, focal length, and image orientation) and values for white balance and picture control as the photograph selected for **Image 1**. The current image comment is appended to the overlay when it is saved; copyright information, however, is not copied. Overlays saved in NEF (RAW) format use the compression selected for **Type** in the **NEF (RAW) recording** menu and have the same bit depth as the original images; JPEG overlays are saved using size-priority compression.





Create JPEG copies of NEF (RAW) photographs.

## 1 Select NEF (RAW) processing.

Highlight **NEF (RAW) processing** in the retouch menu and press  to display a picture selection dialog listing only NEF (RAW) images created with this camera.



## 2 Select a photograph.

Use the multi selector to highlight a photograph (to view the highlighted photograph full frame, press and hold the  button; to view images in other locations, press  and select the desired card and folder as described on page 217). Press  to select the highlighted photograph and proceed to the next step.



### 3 Adjust NEF (RAW) processing settings.

Choose image quality (☰ 68), image size (☰ 71), white balance (☰ 134), exposure compensation (☰ 118), a Picture Control (☰ 154; note that the Picture Control grid can not be displayed) and high ISO noise reduction (☰ 259), and color space (☰ 166) for the JPEG copy. Note that white balance is not available with multiple exposures or pictures created with image overlay and that exposure compensation increments differ from those used in shooting mode.

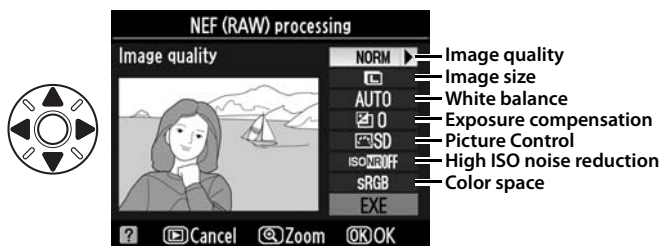

### 4 Copy the photograph.

Highlight **EXE** and press **OK** to create a JPEG copy of the selected photograph. To exit without copying the photograph, press the **MENU** button.



Create small copies of selected photographs. **Resize** can be used during full-frame playback as described on page 316. If you select **Resize** in the retouch menu, you can resize multiple photographs as described below.

## 1 Choose a destination.

If two memory cards are inserted, you can choose a destination for the resized copy by highlighting **Choose destination** and pressing **▶** (if only one card is inserted, proceed to Step 2).



The menu shown at right will be displayed; highlight a card slot and press **OK**.

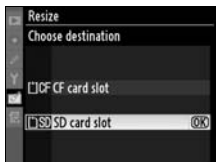

## 2 Choose a size.

Highlight **Choose size** and press **▶**.

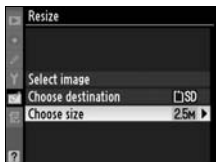

The following options will be displayed; highlight an option and press **OK**.

Option	Size (pixels)	Option	Size (pixels)
<b>2.5 M</b>	1920 × 1280	<b>0.6 M</b>	960 × 640
<b>1.1 M</b>	1280 × 856	<b>0.3 M</b>	640 × 424



### 3 Choose pictures.

Highlight **Select image** and press **▶**.

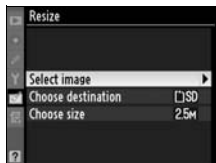

The dialog shown at right will be displayed; highlight pictures using the multi selector and press the center of the multi selector to select or deselect (to view the



highlighted picture full screen, press and hold the **Ⓞ** button; to view images in other locations, press **Ⓞ** and select the desired card and folder as described on page 217). Selected pictures are marked by a **■** icon. Press **OK** when the selection is complete.

### 4 Save the resized copies.

A confirmation dialog will be displayed. Highlight **Yes** and press **OK** to save the resized copies.

#### Viewing Resized Copies

Playback zoom may not be available when resized copies are displayed.

#### Image Quality

Copies created from NEF (RAW), NEF (RAW) + JPEG, or TIFF (RGB) photos have an image quality (📄 68) of JPEG fine; copies created from JPEG photos have the same image quality as the original.







Compare retouched copies to the original photographs. This option is only available if the  button is pressed to display the retouch menu when a copy or original is played back full frame.

### ■ Making a Side-by-Side Comparison

#### 1 Select a picture.

Select a retouched copy (shown by a  icon) or a photograph that has been retouched in full-frame playback and press .





#### 2 Select Side-by-side comparison.

Highlight **Side-by-side comparison** and press .





### 3 Compare the copy with the original.

The source image is displayed on the left, the retouched copy on the right, with the options used to create the copy listed at the top of the display. Press ◀ or ▶ to switch between the source image and the

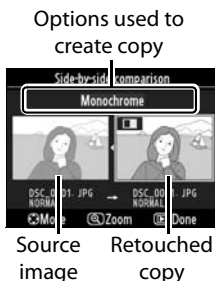
retouched copy. To view the highlighted picture full frame, press and hold the  button. If the copy was created from two images using **Image overlay**, press ▲ or ▼ to view the other source image. To exit to playback mode, press the  button. To exit to playback mode with the highlighted image displayed, press .



#### Side-by-Side Comparison

The source image will not be displayed if the copy was created from a photograph that was protected ( 219), is on a locked memory card, has since been deleted or hidden ( 245), or contains embedded image authentication information ( 308).



# My Menu: *Creating a Custom Menu*

To display My Menu, press **MENU** and select the  (My Menu) tab.

## MENU button



The **My Menu** option can be used to create and edit a customized list of options from the playback, shooting, Custom Settings, setup, and retouch menus for quick access (up to 20 items). If desired, recent settings can be displayed in place of My Menu ( 337).

Options can be added, deleted, and reordered as described below.

## Adding Options to My Menu

### 1 Select Add items.

In My Menu () , highlight **Add items** and press **▶**.

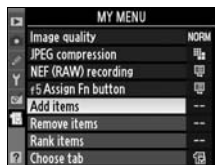

### 2 Select a menu.

Highlight the name of the menu containing the option you wish to add and press **▶**.

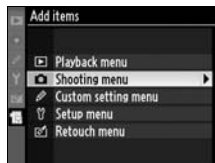

### 3 Select an item.

Highlight the desired menu item and press **OK**.

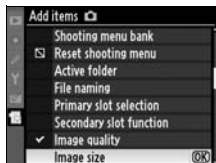

### 4 Position the new item.

Press **▲** or **▼** to move the new item up or down in My Menu. Press **OK** to add the new item.



### 5 Add more items.

The items currently displayed in My Menu are indicated by a check mark. Items indicated by a  icon can not be selected. Repeat steps 1–4 to select additional items.

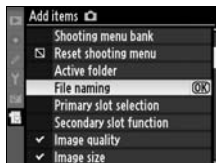

# Deleting Options from My Menu

## 1 Select Remove items.

In My Menu (MENU), highlight **Remove items** and press ►.

## 2 Select items.

Highlight items and press ► to select or deselect. Selected items are indicated by a check mark.

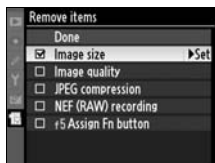

## 3 Select Done.

Highlight **Done** and press OK. A confirmation dialog will be displayed.

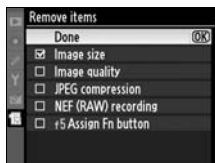

## 4 Delete the selected items.

Press OK to delete the selected items.



### Deleting Items in My Menu

To delete the item currently highlighted in My Menu, press the MENU button. A confirmation dialog will be displayed; press MENU again to remove the selected item from My Menu.



# Reordering Options in My Menu

## 1 Select Rank items.

In My Menu (MENU), highlight **Rank items** and press ►.

## 2 Select an item.

Highlight the item you wish to move and press OK.





## 3 Position the item.



Press ▲ or ▼ to move the item up or down in My Menu and press OK. Repeat Steps 2–3 to reposition additional items.



# Displaying Recent Settings



To display the twenty most recently used settings, select  **Recent settings** for  **My Menu** > **Choose tab**.

## 1 Select Choose tab.

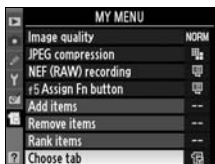

In My Menu () , highlight **Choose tab** and press .



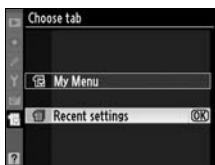

## 2 Select Recent settings.

Highlight  **Recent settings** and press . The name of the menu will change from “MY MENU” to “RECENT SETTINGS.”



Menu items will be added to the top of the recent settings menu as they are used. To view My Menu again, select  **My Menu** for  **Recent settings** > **Choose tab**.

### Removing Items from the Recent Settings Menu

To remove an item from the recent settings menu, highlight it and press the  button. A confirmation dialog will be displayed; press  again to delete the selected item.









# Technical Notes

## – Camera Care, Options, and Resources

Read this chapter for information on compatible accessories, cleaning and storing the camera, and what to do if an error message is displayed or you encounter problems using the camera.

<b>Compatible Lenses</b> .....	<b>340</b>
<b>Optional Flash Units (Speedlights)</b> .....	<b>347</b>
<b>Other Accessories</b> .....	<b>352</b>
<b>Caring for the Camera</b> .....	<b>357</b>
Storage .....	357
Cleaning.....	357
The Low-Pass Filter.....	358
“Clean Now” .....	358
“Clean at Startup/Shutdown” .....	359
Manual Cleaning.....	361
<b>Caring for the Camera and Battery: Cautions</b> .....	<b>364</b>
<b>Defaults</b> .....	<b>368</b>
<b>Exposure Program</b> .....	<b>372</b>
<b>Troubleshooting</b> .....	<b>373</b>
<b>Error Messages</b> .....	<b>378</b>
<b>Specifications</b> .....	<b>385</b>
<b>Approved Memory Cards</b> .....	<b>393</b>
<b>Memory Card Capacity</b> .....	<b>394</b>
<b>Battery Life</b> .....	<b>396</b>



# Compatible Lenses

CPU lenses (particularly types G and D) are recommended for use with the D300S. CPU lenses can be identified by the presence of CPU contacts, type G and D lenses by a letter on the lens barrel. Type G lenses are not equipped with a lens aperture ring.

CPU contacts

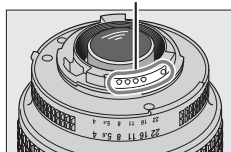

CPU lens

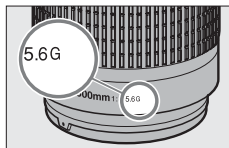

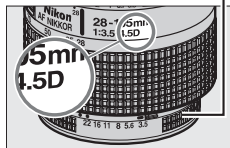

Type G lens

Aperture ring



Type D lens

## Compatible CPU Lenses<sup>1</sup>

Lens/accessory	Camera setting		Focus mode			Exposure mode		Metering system	
	S C	M (with electronic rangefinder)	M	P S	A M				
						3D	Color		
Type G or D AF NIKKOR <sup>2</sup> AF-S, AF-I NIKKOR	✓	✓	✓	✓	✓	✓	—	—	✓ <sup>3</sup>
PC-E NIKKOR series	—	✓ <sup>4</sup>	✓	✓ <sup>4</sup>	✓ <sup>4</sup>	✓ <sup>4</sup>	—	—	✓ <sup>3,4</sup>
PC Micro 85mm f/2.8D <sup>5</sup>	—	✓ <sup>4</sup>	✓	—	✓ <sup>6</sup>	✓	—	—	✓ <sup>3,4</sup>
AF-S / AF-I Teleconverter <sup>7</sup>	✓ <sup>8</sup>	✓ <sup>8</sup>	✓	✓	✓	✓	—	—	✓ <sup>3</sup>
Other AF NIKKOR (except lenses for F3AF)	✓ <sup>9</sup>	✓ <sup>9</sup>	✓	✓	✓	—	—	—	✓ <sup>3</sup>
AI-P NIKKOR	—	✓ <sup>10</sup>	✓	✓	✓	—	—	—	✓ <sup>3</sup>

1 IX-NIKKOR lenses can not be used.

2 Vibration Reduction (VR) supported with VR lenses.

3 Spot metering meters selected focus point.

4 Can not be used with shifting or tilting.

5 The camera's exposure metering and flash control systems do not work properly when shifting and/or tilting the lens, or when an aperture other than the maximum aperture is used.

6 Manual exposure mode only.

7 Can be used with AF-S and AF-I lenses only (☐ 341).

8 With maximum effective aperture of f/5.6 or faster.

- 9 When focusing at minimum focus distance with AF 80–200mm f/2.8, AF 35–70mm f/2.8, AF 28–85mm f/3.5–4.5 <New>, or AF 28–85mm f/3.5–4.5 lens at maximum zoom, in-focus indicator may be displayed when image on matte screen in viewfinder is not in focus. Adjust focus manually until image in viewfinder is in focus.
- 10 With maximum aperture of f/5.6 or faster.

### **The AF-S/AF-I Teleconverter**

The AF-S/AF-I teleconverter can be used with the following AF-S and AF-I lenses:

- AF-S VR Micro 105mm f/2.8G ED<sup>1</sup>
- AF-S VR 200mm f/2G ED
- AF-S VR 300mm f/2.8G ED
- AF-S 300mm f/2.8D ED II
- AF-S 300mm f/2.8D ED
- AF-I 300mm f/2.8D ED
- AF-S 300mm f/4D ED<sup>2</sup>
- AF-S 400mm f/2.8D ED II
- AF-S 400mm f/2.8D ED
- AF-I 400mm f/2.8D ED
- AF-S 500mm f/4D ED II<sup>2</sup>
- AF-S 500mm f/4D ED<sup>2</sup>
- AF-I 500mm f/4D ED<sup>2</sup>
- AF-S 600mm f/4D ED II<sup>2</sup>
- AF-S 600mm f/4D ED<sup>2</sup>
- AF-I 600mm f/4D ED<sup>2</sup>
- AF-S NIKKOR 70–200mm f/2.8G ED VR II
- AF-S VR 70–200mm f/2.8G ED
- AF-S 80–200mm f/2.8D ED
- AF-S VR 200–400mm f/4G ED<sup>2</sup>
- AF-S NIKKOR 400mm f/2.8G ED VR
- AF-S NIKKOR 500mm f/4G ED VR<sup>2</sup>
- AF-S NIKKOR 600mm f/4G ED VR<sup>2</sup>

1 Autofocus not supported.

2 Autofocus not supported when used with AF-S Teleconverter TC-17E II/TC-20E II.

### **Lens f-number**

The f-number given in lens names is the maximum aperture of the lens.



## Non-CPU Lenses <sup>1</sup>

Non-CPU lenses include manual focus lenses and other lenses without a built-in CPU. The following is a list of compatible non-CPU lenses and accessories.

Camera setting  Lens/accessory	Focus mode			Exposure mode		Metering system		
	S C	M (with electronic rangefinder)	M	P S	A M			
						3D	Color	
AI-, AI-modified, NIKKOR or Nikon Series E lenses <sup>2</sup>	—	✓ <sup>3</sup>	✓	—	✓ <sup>4</sup>	—	✓ <sup>5</sup>	✓ <sup>6</sup>
Medical-NIKKOR 120mm f/4	—	✓	✓	—	✓ <sup>7</sup>	—	—	—
Reflex-NIKKOR	—	—	✓	—	✓ <sup>4</sup>	—	—	✓ <sup>6</sup>
PC-NIKKOR	—	✓ <sup>8</sup>	✓	—	✓ <sup>9</sup>	—	—	✓
AI-type Teleconverter <sup>10</sup>	—	✓ <sup>11</sup>	✓	—	✓ <sup>4</sup>	—	✓ <sup>5</sup>	✓ <sup>6</sup>
PB-6 Bellows Focusing Attachment <sup>12</sup>	—	✓ <sup>11</sup>	✓	—	✓ <sup>13</sup>	—	—	✓
Auto extension rings (PK-series 11A, 12, or 13; PN-11)	—	✓ <sup>11</sup>	✓	—	✓ <sup>4</sup>	—	—	✓

- Some lenses can not be used (see page 343).
- Range of rotation for AI 80–200mm f/2.8 ED tripod mount is limited by camera body. Filters can not be exchanged while AI 200–400mm f/4 ED is mounted on camera.
- With maximum aperture of f/5.6 or faster.
- If maximum aperture is specified using **Non-CPU lens data** ( 195), aperture value will be displayed in viewfinder and control panel.
- Can be used only if lens focal length and maximum aperture are specified using **Non-CPU lens data** ( 195). Use spot or center-weighted metering if desired results are not achieved.
- For improved precision, specify lens focal length and maximum aperture using **Non-CPU lens data** ( 195).
- Can be used in manual exposure mode at shutter speeds slower than flash sync speed by one step or more.
- Electronic rangefinder can not be used with shifting or tilting.
- Exposure determined by presetting lens aperture. In aperture-priority auto exposure mode, preset aperture using lens aperture ring before performing AE lock and shifting lens. In manual exposure mode, preset aperture using lens aperture ring and determine exposure before shifting lens.
- Exposure compensation required when used with AI 28–85mm f/3.5–4.5, AI 35–105mm f/3.5–4.5, AI 35–135mm f/3.5–4.5, or AF-S 80–200mm f/2.8D. See teleconverter manual for details.

- 11 With maximum effective aperture of f/5.6 or faster.
  - 12 Requires PK-12 or PK-13 auto extension ring. PB-6D may be required depending on camera orientation.
  - 13 Use preset aperture. In aperture-priority auto exposure mode, set aperture using focusing attachment before determining exposure and taking photograph.
- PF-4 Reprocopy Outfit requires PA-4 Camera Holder.

### **Compatible Non-CPU Lenses**

If lens data are specified using **Non-CPU lens data** (📖 195), many of the features available with CPU lenses can also be used with non-CPU lenses. If lens data are not specified, color matrix metering can not be used, and center-weighted metering is used when matrix metering is selected.

Non-CPU lenses can only be used in exposure modes **A** and **M**, when aperture must be set using the lens aperture ring. If the maximum aperture has not been specified using **Non-CPU lens data**, the camera aperture display will show the number of stops from maximum aperture; the actual aperture value must be read off the lens aperture ring. Aperture-priority auto will be selected automatically in exposure modes **P** and **S**. The exposure-mode indicator (**P** or **S**) in the control panel will blink, and **A** will be displayed in the viewfinder.

### **Incompatible Accessories and Non-CPU Lenses**

The following can NOT be used with the D300S:

- TC-16AS AF teleconverter
- Non-AI lenses
- Lenses that require the AU-1 focusing unit (400mm f/4.5, 600mm f/5.6, 800mm f/8, 1200mm f/11)
- Fisheye (6mm f/5.6, 7.5mm f/5.6, 8mm f/8, OP 10mm f/5.6)
- 2.1cm f/4
- Extension Ring K2
- 180–600mm f/8 ED (serial numbers 174041–174180)
- 360–1200mm f/11 ED (serial numbers 174031–174127)
- 200–600mm f/9.5 (serial numbers 280001–300490)
- AF lenses for the F3AF (AF 80mm f/2.8, AF 200mm f/3.5 ED, AF Teleconverter TC-16)
- PC 28mm f/4 (serial number 180900 or earlier)
- PC 35mm f/2.8 (serial numbers 851001–906200)
- PC 35mm f/3.5 (old type)
- Reflex 1000mm f/6.3 (old type)
- Reflex 1000mm f/11 (serial numbers 142361–143000)
- Reflex 2000mm f/11 (serial numbers 200111–200310)



### **The Built-in Flash**

The built-in flash can be used with CPU lenses with focal lengths of 16–300 mm. Remove lens hoods to prevent shadows. The flash has a minimum range of 60 cm (2 ft.) and can not be used in the macro range of macro zoom lenses. The flash may be unable to light the entire subject with the following lenses at ranges less than those given below:

<b>Lens</b>	<b>Zoom position</b>	<b>Minimum range</b>
AF-S DX NIKKOR 10–24mm f/3.5–4.5G ED	18 mm	1.0 m/3 ft. 3 in.
	20 mm	0.7 m/2 ft. 4 in.
AF-S DX 12–24mm f/4G ED	18 mm	1.5 m/4 ft. 11 in.
	20 mm	1.0 m/3 ft. 3 in.
AF-S DX NIKKOR 16–85mm f/3.5–5.6G ED VR	16 mm	0.7 m/2 ft. 4 in.
AF-S 17–35mm f/2.8D ED	24 mm	1.0 m/3 ft. 3 in.
AF-S DX 17–55mm f/2.8G ED	24 mm	1.0 m/3 ft. 3 in.
AF 18–35mm f/3.5–4.5D ED	18 mm	1.5 m/4 ft. 11 in.
AF-S DX 18–135mm f/3.5–5.6G ED	18 mm	1.0 m/3 ft. 3 in.
AF-S DX VR 18–200mm f/3.5–5.6G ED	18 mm	1.0 m/3 ft. 3 in.
AF 20–35mm f/2.8D	20 mm	1.0 m/3 ft. 3 in.
	28 mm	1.5 m/4 ft. 11 in.
AF-S NIKKOR 24–70mm f/2.8G ED	35 mm	1.0 m/3 ft. 3 in.
	28 mm	1.5 m/4 ft. 11 in.
AF-S 28–70mm f/2.8D ED	35 mm	1.0 m/3 ft. 3 in.
	24 mm	1.0 m/3 ft. 3 in.
PC-E NIKKOR 24mm f/3.5 ED (when not tilted or shifted)	24 mm	1.0 m/3 ft. 3 in.

When used with the AF-S NIKKOR 14–24mm f/2.8G ED, the flash will be unable to light the entire subject at all ranges.

The built-in flash can also be used with AI-S, AI-, AI-modified NIKKOR, Nikon Series E and non-CPU lenses with a focal length of 16–300mm. AI 50–300mm f/4.5, modified AI 50–300mm f/4.5, and AI-S 50–300mm f/4.5 ED lenses must be used at a zoom position of 135 mm or above, and AI 50–300mm f/4.5 ED lenses at a zoom position of 105 mm or above.

### **Red-Eye Reduction**

Lenses that block the subject's view of the AF-assist illuminator may interfere with red-eye reduction.

## **AF-Assist Illumination**

The AF-assist illumination is available with lenses with focal lengths of 24–200mm. It can not however be used to assist the focus operation with the following lenses:

- AF-S VR 200mm f/2G ED
- AF-S VR 200–400mm f/4G ED

At ranges under 0.7 m (2ft. 4in.), the following lenses may block the AF-assist illuminator and interfere with autofocus when lighting is poor:

- AF Micro 200mm f/4D ED
- AF-S DX 17–55mm f/2.8G ED
- AF-S VR 24–120mm f/3.5–5.6G ED
- AF-S NIKKOR 24–70mm f/2.8G ED
- AF Micro 70–180mm f/4.5–5.6D ED
- AF-S 28–70mm f/2.8D ED
- AF-S 17–35mm f/2.8D ED

At ranges under 1.1 m (3ft. 7in.), the following lens may block the AF-assist illuminator and interfere with autofocus when lighting is poor:

- AF-S DX VR 55–200mm f/4–5.6G ED

At ranges under 1.5 m (4ft. 11 in.), the following lenses may block the AF-assist illuminator and interfere with autofocus when lighting is poor:

- AF-S DX NIKKOR 18–200mm f/3.5–5.6G ED VR II
- AF 80–200mm f/2.8D ED
- AF-S VR 70–200mm f/2.8G ED
- AF-S VR 70–300mm f/4.5–5.6G ED
- AF-S NIKKOR 14–24mm f/2.8G ED
- AF-S 80–200mm f/2.8D

At ranges under 2.3 m (7ft. 7in.), the following lens may block the AF-assist illuminator and interfere with autofocus when lighting is poor:

- AF VR 80–400mm f/4.5–5.6D ED



### Calculating Picture Angle

The size of the area exposed by a 35mm camera is  $36 \times 24$  mm. The size of the area exposed by the D300S, in contrast, is approximately  $23.6 \times 15.8$  mm, meaning that the diagonal picture angle of a 35mm camera is approximately 1.5 times that of the D300S. To calculate the focal length of lenses for the D300S in 35mm format, multiply the focal length of the lens by 1.5 (for example, the effective focal length of a 24mm lens in 35mm format would be 36 mm when mounted on the D300S).

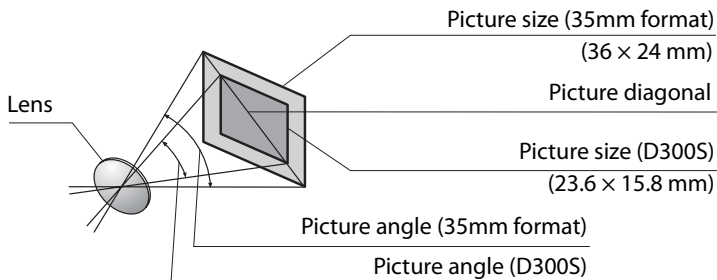



# Optional Flash Units (Speedlights)

The camera supports the Nikon Creative Lighting System (CLS) and can be used with CLS-compatible flash units. Optional flash units can be attached directly to the camera accessory shoe as described below. The accessory shoe is equipped with a safety lock for flash units with a locking pin, such as the SB-900, SB-800, SB-600, and SB-400.

## 1 Remove the accessory shoe cover.

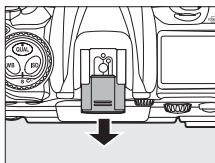

## 2 Mount the flash unit on the accessory shoe.

See the manual provided with the flash unit for details. The built-in flash will not fire when an optional flash unit is attached.

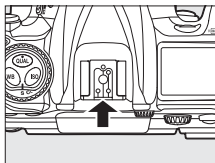

### The Sync Terminal

A sync cable can be connected to the sync terminal as required. Do not connect another flash unit via a sync cable when performing rear-curtain sync flash photography with a flash unit mounted on the camera accessory shoe.

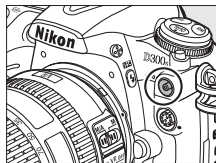

# The Nikon Creative Lighting System (CLS)

Nikon's advanced Creative Lighting System (CLS) offers improved communication between the camera and compatible flash units for improved flash photography.

## ■ CLS-Compatible Flash Units

The camera can be used with the following CLS-compatible flash units:

### • The SB-900, SB-800, SB-600, SB-400, and SB-R200:

Flash unit		Flash unit				
		SB-900 <sup>1</sup>	SB-800	SB-600	SB-400	SB-R200 <sup>2</sup>
Guide No. <sup>3</sup>	ISO 100	34/111	38/125	30/98	21/69	10/33
	ISO 200	48/157	53/174	42/138	30/98	14/46

- 1 If a color filter is attached to the SB-900 when AUTO or  $\frac{1}{2}$  (flash) is selected for white balance, the camera will automatically detect the filter and adjust white balance appropriately.
  - 2 Controlled remotely with built-in flash in commander mode or using optional SB-900 or SB-800 flash unit or SU-800 wireless Speedlight commander.
  - 3 m/ft., 20 °C (68 °F), SB-900, SB-800, and SB-600 at 35 mm zoom head position; SB-900 with standard illumination.
- **SU-800 Wireless Speedlight Commander:** When mounted on a CLS-compatible camera, the SU-800 can be used as a commander for remote SB-900, SB-800, SB-600, or SB-R200 flash units. The SU-800 itself is not equipped with a flash.

### Guide Number

To calculate the range of the flash at full power, divide the Guide Number by the aperture. For example, at ISO 100 the SB-800 has a Guide Number of 38 m or 125 ft. (35 mm zoom head position); its range at an aperture of f/5.6 is  $38 \div 5.6$  or about 6.8 meters (or in feet,  $125 \div 5.6 =$  approximately 23 ft. 7 in.). For each twofold increase in ISO sensitivity, multiply the Guide Number by the square root of two (approximately 1.4).

The following features are available with the above flash units:

Flash mode/feature		Flash unit			Advanced Wireless Lighting				
		SB-900 SB-800	SB-600	SB-400	Commander		Remote		
					SB-900 SB-800	SU-800 <sup>1</sup>	SB-900 SB-800	SB-600	SB-R200
i-TTL	i-TTL balanced fill-flash for digital SLR	✓ <sup>2</sup>	✓ <sup>2</sup>	✓ <sup>3</sup>	✓	✓	✓	✓	✓
AA	Auto aperture	✓ <sup>4</sup>	—	—	✓ <sup>5</sup>	✓ <sup>5</sup>	✓ <sup>5</sup>	—	—
A	Non-TTL auto	✓ <sup>6</sup>	—	—	✓ <sup>5</sup>	—	✓ <sup>5</sup>	—	—
GN	Range-priority manual	✓	—	—	—	—	—	—	—
M	Manual	✓	✓	✓ <sup>7</sup>	✓	✓	✓	✓	✓
RPT	Repeating flash	✓	—	—	✓	✓	✓	✓	—
Auto FP High-Speed Sync <sup>8</sup>		✓	✓	—	✓	✓	✓	✓	✓
FV lock		✓	✓	✓	✓	✓	✓	✓	✓
AF-assist for multi-area AF <sup>9</sup>		✓	✓	—	✓	✓	—	—	—
Flash Color Information Communication		✓	✓	✓	✓	—	—	—	—
REAR	Rear-curtain sync	✓	✓	✓	✓	✓	✓	✓	✓
	Red-eye reduction	✓	✓	✓	✓	—	—	—	—
Power zoom		✓	✓	—	✓	—	—	—	—

- 1 Only available when SU-800 is used to control other flash units.
- 2 Standard i-TTL flash for digital SLR is used with spot metering or when selected with flash unit.
- 3 Standard i-TTL flash for digital SLR is used with spot metering.
- 4 Selected with flash unit. Non-TTL auto (A) selected automatically if non-CPU lens is attached without specifying lens data using **Non-CPU lens data**.
- 5 Auto aperture (AA) is used regardless of mode selected with flash unit. Non-TTL auto (A) selected automatically if non-CPU lens is attached without specifying lens data using **Non-CPU lens data**.
- 6 Selected with flash unit.
- 7 Can be selected with camera.
- 8 Select **1/320 s (Auto FP)** or **1/250 s (Auto FP)** for Custom Setting e1 (**Flash sync speed**,  281).
- 9 CPU lens required.



## Other Flash Units

The following flash units can be used in non-TTL auto and manual modes. If they are set to TTL, the camera shutter-release button will lock and no photographs can be taken.

Flash unit	SB-80DX, SB-28DX, SB-28, SB-26, SB-25, SB-24	SB-50DX	SB-30, SB-27 <sup>1</sup> , SB-22S, SB-22, SB-20, SB-16B, SB-15	SB-23, SB-29 <sup>2</sup> , SB-21B <sup>2</sup> , SB-29S <sup>2</sup>
<b>A</b> Non-TTL auto	✓	—	✓	—
<b>M</b> Manual	✓	✓	✓	✓
 Repeating flash	✓	—	—	—
<b>REAR</b> Rear-curtain sync	✓	✓	✓	✓

- 1 Flash mode is automatically set to TTL and shutter-release is disabled. Set flash unit to **A** (non-TTL auto flash).
- 2 Autofocus is only available with AF-Micro lenses (60 mm, 105 mm, or 200 mm).

### Notes on Optional Flash Units

Refer to the flash unit manual for detailed instructions. If the unit supports CLS, refer to the section on CLS-compatible digital SLR cameras. The D300S is not included in the “digital SLR” category in the SB-80DX, SB-28DX, and SB-50DX manuals.

i-TTL flash control can be used at ISO sensitivities between 200 and 3200. At values over 3200, the desired results may not be achieved at some ranges or aperture settings. If the flash-ready indicator blinks for about three seconds after a photograph is taken, the flash has fired at full power and the photograph may be underexposed.

When an SC-series 17, 28, or 29 sync cable is used for off-camera flash photography, correct exposure may not be achieved in i-TTL mode. We recommend that you select standard i-TTL flash control. Take a test shot and view the results in the monitor.

In i-TTL, use the flash panel or bounce adapter provided with the flash unit. Do not use other panels such as diffusion panels, as this may produce incorrect exposure.

## ✓ Notes on Optional Flash Units (Continued)

The SB-900, SB-800, SB-600, and SB-400 provide red-eye reduction, while the SB-900, SB-800, SB-600, and SU-800 provide AF-assist illumination with the following restrictions:

- **SB-900:** AF-assist illumination is available for all focus points; with 17–135 mm AF lenses, however, autofocus is not available with the focus points shown in gray.

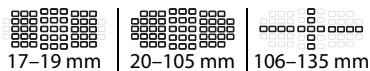

- **SB-800, SB-600 and SU-800:** With 24–105 mm AF lenses, AF-assist illumination is not available with the focus points shown in gray.



With other flash units, the camera AF-assist illuminator is used for AF-assist illumination and red-eye reduction.

In programmed auto, the maximum aperture (minimum f-number) is limited according to sensitivity (ISO equivalency), as shown at right.

Maximum aperture at ISO equivalent of:				
200	400	800	1600	3200
5	5.6	7.1	8	10

## ✓ Use Only Nikon Flash Accessories

*Use only Nikon flash units.* Negative voltages or voltages over 250 V applied to the accessory shoe could not only prevent normal operation, but damage the sync circuitry of the camera or flash. Before using a Nikon flash unit not listed in this section, contact a Nikon-authorized service representative for more information.



# Other Accessories

At the time of writing, the following accessories were available for the D300S.

<b>Power sources</b>	<ul style="list-style-type: none"><li>• <b>Rechargeable Li-ion Battery EN-EL3e</b> (□ 22, 24).</li><li>• <b>Multi-Power Battery Pack MB-D10:</b> The MB-D10 is equipped with a shutter-release button, <b>AF-ON</b> button, multi selector, and main- and sub-command dials for improved operation when taking photographs in portrait (tall) orientation. When attaching the MB-D10, remove contact cover for the MB-D10 from the camera. A BL-3 battery-chamber cover is required when using EN-EL4a or EN-EL4 batteries.</li><li>• <b>Quick Charger MH-18a</b> (□ 22): The MH-18a can be used to recharge EN-EL3e battery.</li><li>• <b>AC Adapter EH-5a/EH-5:</b> These AC adapters can be used to power the camera for extended periods.</li></ul>
<b>Wireless LAN adapters</b>	<ul style="list-style-type: none"><li>• <b>Wireless Transmitter WT-4:</b> Connects the camera to wireless and Ethernet networks. The photographs on the camera memory card can be viewed by computers on the same network or copied to a computer for long-term storage. The camera can also be controlled from any computer on the network using Camera Control Pro 2 (available separately). Note that the WT-4 requires an independent power source; an EH-6 AC adapter or a second EN-EL3e battery is recommended. See the WT-4 manual for details.</li></ul>



**Viewfinder  
eyepiece  
accessories**

- **Dioptric-Adjustment Viewfinder Lens DK-20C:** To accommodate individual differences in vision, viewfinder lenses are available with diopters of  $-5$ ,  $-4$ ,  $-3$ ,  $-2$ ,  $0$ ,  $+0.5$ ,  $+1$ ,  $+2$ , and  $+3$   $m^{-1}$ . Use diopter adjustment lenses only if the desired focus can not be achieved with the built-in diopter adjustment control ( $-2$  to  $+1$   $m^{-1}$ ). Test diopter adjustment lenses before purchase to ensure that the desired focus can be achieved. The rubber eyecup can not be used with diopter adjustment lenses.
- **Magnifying Eyepiece DK-21M:** The DK-21M magnifies the view through the viewfinder by approximately  $1.17 \times$  ( $50$  mm  $f/1.4$  lens at infinity;  $-1.0$   $m^{-1}$ ) for greater precision when framing.
- **Magnifier DG-2:** The DG-2 magnifies the scene displayed in the viewfinder. Use for close-up photography, copying, telephoto lenses, and other tasks that call for added precision. DK-22 eyepiece adapter (available separately) required.
- **Eyepiece Adapter DK-22:** The DK-22 is used when attaching the DG-2 magnifier to the D300S.
- **Right-Angle Viewing Attachment DR-6:** The DR-6 attaches to the viewfinder eyepiece at a right angle, allowing the image in the viewfinder to be viewed from above when the camera is in the horizontal shooting position.



<b>Filters</b>	<ul style="list-style-type: none"> <li>• Nikon filters can be divided into three types: screw-on, slip-in, and rear-interchange. Use Nikon filters; filters manufactured by other makers may interfere with autofocus or electronic range finding.</li> <li>• The D300S can not be used with linear polarizing filters. Use the C-PL circular polarizing filter instead.</li> <li>• Use NC and L37C filters to protect the lens.</li> <li>• To prevent ghosting, use of a filter is not recommended when the subject is framed against a bright light, or when a bright light source is in the frame.</li> <li>• Center-weighted metering is recommended with filters with exposure factors (filter factors) over 1 × (Y44, Y48, Y52, O56, R60, X0, X1, C-PL, ND2S, ND4, ND4S, ND8, ND8S, ND400, A2, A12, B2, B8, B12). See the filter manual for details.</li> </ul>
<b>Optional flash units</b>	<ul style="list-style-type: none"> <li>• <b>Nikon Speedlights SB-900, SB-800, SB-600, and SB-400</b></li> <li>• <b>Nikon Wireless Remote Speedlight SB-R200</b></li> <li>• <b>Wireless Speedlight Commander SU-800</b> See page 348 for more information.</li> </ul>
<b>Water guards</b>	<ul style="list-style-type: none"> <li>• <b>Water Guard WG-AS2:</b> The optional WG-AS2 is a water guard that covers the base of SB-900 flash units mounted on the D300S, increasing the SB-900's splash resistance by protecting the accessory shoe contacts from rain and spray.</li> </ul>
<b>PC card adapters</b>	<ul style="list-style-type: none"> <li>• <b>EC-AD1 PC Card Adapter:</b> The EC-AD1 PC card adapter allows Type I CompactFlash memory cards to be inserted in PCMCIA card slots.</li> </ul>





<b>Software</b>	<ul style="list-style-type: none"><li>• <b>Capture NX 2:</b> A complete photo editing package with such advanced editing features as selection control points and an auto retouch brush.</li><li>• <b>Camera Control Pro 2:</b> Control the camera remotely from a computer and save photographs directly to the computer hard disk.</li><li>• <b>Image Authentication:</b> Determine whether photographs taken with image authentication (📖 308) on have been modified after shooting.</li></ul> <p><b>Note:</b> Use the latest versions of Nikon software. Most Nikon software offers an auto update feature when the computer is connected to the Internet. See the websites listed on page xxiv for the latest information on supported operating systems.</p>
<b>Body cap</b>	<ul style="list-style-type: none"><li>• <b>BF-1A Body Cap:</b> The body cap keeps the mirror, viewfinder screen, and low-pass filter free of dust when a lens is not in place.</li></ul>



## Remote terminal accessories

The D300S is equipped with a ten-pin remote terminal for remote control and automatic photography. The terminal is provided with a cap, which protects the contacts when the terminal is not in use. The following

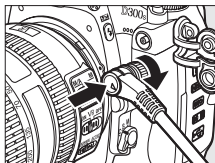

accessories can be used (all lengths are approximate):

- **Remote Cord MC-22:** Remote shutter release with blue, yellow, and black terminals for connection to a remote shutter-triggering device, allowing control via sound or electronic signals (length 1 m/3 ft. 3 in.).
- **Remote Cord MC-30:** Remote shutter release; can be used to reduce camera shake (length 80 cm/2 ft. 7 in.).
- **Remote Cord MC-36:** Remote shutter release; can be used for interval timer photography or to reduce camera shake or keep the shutter open during a time exposure (length 85 cm/2 ft. 9 in.).
- **Extension Cord MC-21:** Can be connected to ML-3 or MC-series 20, 22, 23, 25, 30, or 36. Only one MC-21 can be used at a time (length 3 m/9 ft. 10 in.).
- **Connecting Cord MC-23:** Connects two cameras for simultaneous operation (length 40 cm/1 ft. 4 in.).
- **Adapter Cord MC-25:** Ten-pin to two-pin adapter cord for connection to devices with two-pin terminals, including the MW-2 radio control set, MT-2 intervalometer, and ML-2 modulite control set (length 20 cm/8 in.).
- **GPS Unit GP-1** (□ 198): Record latitude, longitude, altitude, and UTC time with pictures.
- **GPS Adapter Cord MC-35** (□ 198): Connects GPS devices to D300S via PC cable supplied by manufacturer of GPS device, allowing GPS data to be recorded with photographs (length 35 cm/1 ft. 2 in.).
- **Modulite Remote Control Set ML-3:** Allows infrared remote control at ranges of up to 8 m (26 ft. 3 in.).



# Caring for the Camera

## Storage

When the camera will not be used for an extended period, replace the monitor cover, remove the battery, and store the battery in a cool, dry area with the terminal cover in place. To prevent mold or mildew, store the camera in a dry, well-ventilated area. Do not store your camera with naphtha or camphor moth balls or in locations that:

- are poorly ventilated or subject to humidities of over 60%
- are next to equipment that produces strong electromagnetic fields, such as televisions or radios
- are exposed to temperatures above 50 °C (122 °F) or below -10 °C (14 °F)

## Cleaning

<b>Camera body</b>	Use a blower to remove dust and lint, then wipe gently with a soft, dry cloth. After using the camera at the beach or seaside, wipe off sand or salt with a cloth lightly dampened in distilled water and dry thoroughly. <b>Important:</b> <i>Dust or other foreign matter inside the camera may cause damage not covered under warranty.</i>
<b>Lens, mirror, and viewfinder</b>	These glass elements are easily damaged. Remove dust and lint with a blower. If using an aerosol blower, keep the can vertical to prevent the discharge of liquid. To remove fingerprints and other stains, apply a small amount of lens cleaner to a soft cloth and clean with care.
<b>Monitor</b>	Remove dust and lint with a blower. When removing fingerprints and other stains, wipe the surface lightly with a soft cloth or chamois leather. Do not apply pressure, as this could result in damage or malfunction.

*Do not use alcohol, thinner, or other volatile chemicals.*



# The Low-Pass Filter

The image sensor that acts as the camera's picture element is fitted with a low-pass filter to prevent moiré. If you suspect that dirt or dust on the filter is appearing in photographs, you can clean the filter using the **Clean image sensor** option in the setup menu. The filter can be cleaned at any time using the **Clean now** option, or cleaning can be performed automatically when the camera is turned on or off.

## ■ "Clean Now"

### 1 Place the camera base down.

Image sensor cleaning is most effective when the camera is placed base down as shown at right.

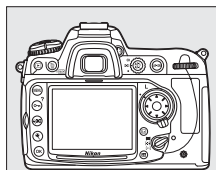

### 2 Display the Clean image sensor menu.

Press **MENU** to display the menus. Highlight **Clean image sensor** in the setup menu and press **▶**.

#### MENU button

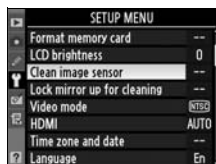
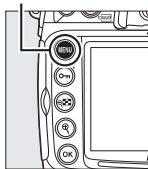

### 3 Select **Clean now**.

Highlight **Clean now** and press

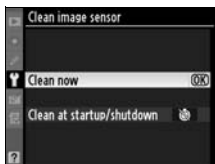

The message shown at right will be displayed while cleaning is in progress.



The message shown at right will be displayed when cleaning is complete.



### ■ *“Clean at Startup/Shutdown”*

#### 1 Select **Clean at startup/shutdown**.



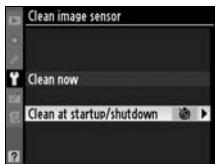

Display the **Clean image sensor** menu as described in Step 2 on the previous page. Highlight **Clean at startup/shutdown** and press

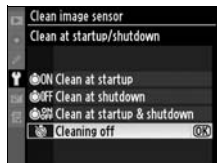

## 2 Select an option.

Highlight one of the following options and press **OK**.



Option	Description
 <b>Clean at startup</b>	The image sensor is automatically cleaned each time the camera is turned on.
 <b>Clean at shutdown</b>	The image sensor is automatically cleaned during shutdown each time the camera is turned off.
 <b>Clean at startup &amp; shutdown</b>	The image sensor is cleaned automatically at startup and at shutdown.
 <b>Cleaning off</b>	Automatic image sensor cleaning off.

### **Image Sensor Cleaning**

Using camera controls interrupts image sensor cleaning. Image sensor cleaning may not be performed at startup if the flash is on.

Cleaning is performed by vibrating the low-pass filter. If dust can not be fully removed using the options in the **Clean image sensor** menu, clean the image sensor manually (📖 361) or consult a Nikon-authorized service representative.

If image sensor cleaning is performed several times in succession, image sensor cleaning may be temporarily disabled to protect the camera's internal circuitry. Cleaning can be performed again after a short wait.

## Manual Cleaning

If foreign matter can not be removed from the low-pass filter using the **Clean image sensor** (☐ 358) option in the setup menu, the filter can be cleaned manually as described below. Note, however, that the filter is extremely delicate and easily damaged. Nikon recommends that the filter be cleaned only by Nikon-authorized service personnel.

### 1 Charge the battery or connect an AC adapter.

A reliable power source is required when inspecting or cleaning the low-pass filter. If the battery level is below  (60%), turn the camera off and insert a fully-charged EN-EL3e battery or connect an optional EH-5a or EH-5 AC adapter.

### 2 Select Lock mirror up for cleaning.

Remove the lens and turn the camera on. Highlight **Lock mirror up for cleaning** in the setup menu and press **▶** (note that this option is not available at battery levels of  or below).



### 3 Press **OK**.

The message shown at right will be displayed in the monitor and a row of dashes will appear in the control panel and viewfinder. To restore normal operation without inspecting the low-pass filter, turn the camera off.

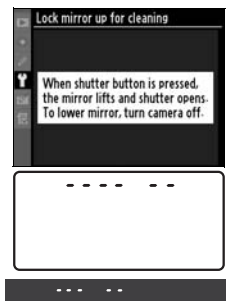

---

## 4 Raise the mirror.

Press the shutter-release button all the way down. The mirror will be raised and the shutter curtain will open, revealing the low-pass filter. The display in the viewfinder will turn off and the row of dashes in the control panel will blink.



---

## 5 Examine the low-pass filter.

Holding the camera so that light falls on the low-pass filter, examine the filter for dust or lint. If no foreign objects are present, proceed to Step 7.

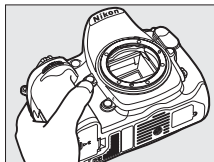

---

## 6 Clean the filter.

Remove any dust and lint from the filter with a blower. Do not use a blower-brush, as the bristles could damage the filter. Dirt that can not be removed with a blower can only be removed by Nikon-authorized service personnel. Under no circumstances should you touch or wipe the filter.



---

## 7 Turn the camera off.

The mirror will return to the down position and the shutter curtain will close. Replace the lens or body cap.



### **Use a Reliable Power Source**

The shutter curtain is delicate and easily damaged. If the camera powers off while the mirror is raised, the curtain will close automatically. To prevent damage to the curtain, observe the following precautions:

- Do not turn the camera off or remove or disconnect the power source while the mirror is raised.
- If the battery runs low while the mirror is raised, a beep will sound and the self-timer lamp will blink to warn that the shutter curtain will close and the mirror will be lowered after about two minutes. End cleaning or inspection immediately.

### **Foreign Matter on the Low-Pass Filter**

Nikon takes every possible precaution to prevent foreign matter from coming into contact with the low-pass filter during production and shipping. The D300S, however, is designed to be used with interchangeable lenses, and foreign matter may enter the camera when lenses are removed or exchanged. Once inside the camera, this foreign matter may adhere to the low-pass filter, where it may appear in photographs taken under certain conditions. To protect the camera when no lens is in place, be sure to replace the body cap provided with the camera, being careful to first remove all dust and other foreign matter that may be adhering to the body cap.

Should foreign matter find its way onto the low-pass filter, clean the filter as described above, or have the filter cleaned by authorized Nikon service personnel. Photographs affected by the presence of foreign matter on the filter can be retouched using Capture NX 2 (available separately; ☐ 355) or the clean image options available in some third-party imaging applications.

### **Servicing the Camera and Accessories**

The camera is a precision device and requires regular servicing. Nikon recommends that the camera be inspected by the original retailer or Nikon service representative once every one to two years, and that it be serviced once every three to five years (note that fees apply to these services). Frequent inspection and servicing are particularly recommended if the camera is used professionally. Any accessories regularly used with the camera, such as lenses or optional flash units, should be included when the camera is inspected or serviced.



# Caring for the Camera and Battery: Cautions

**Do not drop:** The product may malfunction if subjected to strong shocks or vibration.

**Keep dry:** This product is not waterproof, and may malfunction if immersed in water or exposed to high levels of humidity. Rusting of the internal mechanism can cause irreparable damage.

**Avoid sudden changes in temperature:** Sudden changes in temperature, such as occur when entering or leaving a heated building on a cold day, can cause condensation inside the device. To prevent condensation, place the device in a carrying case or plastic bag before exposing it to sudden changes in temperature.

**Keep away from strong magnetic fields:** Do not use or store this device in the vicinity of equipment that generates strong electromagnetic radiation or magnetic fields. Strong static charges or the magnetic fields produced by equipment such as radio transmitters could interfere with the monitor, damage data stored on the memory card, or affect the product's internal circuitry.

**Do not leave the lens pointed at the sun:** Do not leave the lens pointed at the sun or other strong light source for an extended period. Intense light may cause the image sensor to deteriorate or produce a white blur effect in photographs.



**Cleaning:** When cleaning the camera body, use a blower to gently remove dust and lint, then wipe gently with a soft, dry cloth. After using the camera at the beach or seaside, wipe off any sand or salt using a cloth lightly dampened in pure water and then dry the camera thoroughly. In rare instances, static electricity may cause the LCD displays to light up or go dark. This does not indicate a malfunction, and the display will soon return to normal.

The lens and mirror are easily damaged. Dust and lint should be gently removed with a blower. When using an aerosol blower, keep the can vertical to prevent discharge of liquid. To remove fingerprints and other stains from the lens, apply a small amount of lens cleaner to a soft cloth and wipe the lens carefully.

See “The Low-Pass Filter” (□ 358, 361) for information on cleaning the low-pass filter.

**Lens contacts:** Keep the lens contacts clean.

**Do not touch the shutter curtain:** The shutter curtain is extremely thin and easily damaged. Under no circumstances should you exert pressure on the curtain, poke it with cleaning tools, or subject it to powerful air currents from a blower. These actions could scratch, deform, or tear the curtain.

**Storage:** To prevent mold or mildew, store the camera in a dry, well-ventilated area. If the product will not be used for an extended period, remove the battery to prevent leakage and store the camera in a plastic bag containing a desiccant. Do not, however, store the camera case in a plastic bag, as this may cause the material to deteriorate. Note that desiccant gradually loses its capacity to absorb moisture and should be replaced at regular intervals.

To prevent mold or mildew, take the camera out of storage at least once a month. Turn the camera on and release the shutter a few times before putting it away.

Store the battery in a cool, dry place. Replace the terminal cover before putting the battery away.



**Turn the product off before removing or disconnecting the power source:** Do not unplug the product or remove the battery while the product is on or while images are being recorded or deleted. Forcibly cutting power in these circumstances could result in loss of data or in damage to product memory or internal circuitry. To prevent an accidental interruption of power, avoid carrying the product from one location to another while the AC adapter is connected.

**Notes on the monitor:** The monitor may contain a few pixels that are always lit or that do not light. This is common to all TFT LCD monitors and does not indicate a malfunction. Images recorded with the product are unaffected.

Images in the monitor may be difficult to see in a bright light.

Do not apply pressure to the monitor, as this could cause damage or malfunction. Dust or lint on the monitor can be removed with a blower. Stains can be removed by wiping lightly with a soft cloth or chamois leather. Should the monitor break, care should be taken to avoid injury from broken glass and to prevent liquid crystal from the monitor touching the skin or entering the eyes and mouth.

Replace the monitor cover when transporting the camera or leaving it unattended.



**Batteries:** Dirt on the battery terminals can prevent the camera from functioning and should be removed with a soft, dry cloth before use.

Batteries may leak or explode if improperly handled. Observe the following precautions when handling batteries:

Turn the product off before replacing the battery.

The battery may become hot when used for extended periods. Observe due caution when handling the battery.

Use only batteries approved for use in this equipment.

Do not expose the battery to flame or excessive heat.

After removing the battery from the camera, be sure to replace the terminal cover.

Charge the battery before use. When taking photographs on important occasions, ready a spare EN-EL3e battery and keep it fully charged. Depending on your location, it may be difficult to purchase replacement batteries on short notice.

On cold days, the capacity of batteries tends to decrease. Be sure the battery is fully charged before taking photographs outside in cold weather. Keep a spare battery in a warm place and exchange the two as necessary. Once warmed, a cold battery may recover some of its charge.

Continuing to charge the battery after it is fully charged can impair battery performance.

Used batteries are a valuable resource. Please recycle used batteries in accord with local regulations.



# Defaults

The default settings for the options in the camera menus are listed below. For information on two-button resets, see page 182.

## ■ Playback Menu Defaults

Option	Default
Playback folder (☞ 244)	D300S
Image review (☞ 251)	Off
After delete (☞ 251)	Show next
Rotate tall (☞ 251)	Off
Slide show (☞ 252)	
Frame interval (☞ 252)	2 s

## ■ Shooting Menu Defaults <sup>1</sup>

Option	Default
File naming (☞ 258)	DSC
Primary slot selection (☞ 72)	CF card slot
Secondary slot function (☞ 72)	Overflow
Image quality (☞ 68)	JPEG normal
Image size (☞ 71)	Large
JPEG compression (☞ 70)	Size priority
NEF (RAW) recording (☞ 70)	
Type	Lossless compressed
NEF (RAW) bit depth	12-bit
White balance (☞ 134)	Auto
Fine tuning (☞ 137)	Off
Choose color temp. (☞ 141)	5000 K
Set Picture Control (☞ 154)	Standard
Color space (☞ 166)	sRGB
Active D-Lighting (☞ 165)	Off
Long exp. NR (☞ 258)	Off
High ISO NR (☞ 259)	Normal
ISO sensitivity settings (☞ 96)	
ISO sensitivity (☞ 96)	200
ISO sensitivity auto control (☞ 98)	Off

Live view mode (☐ 49, 52)	Tripod
Multiple exposure (☐ 184)	Reset <sup>2</sup>
Movie settings (☐ 62)	
Quality	640 × 424 (3 : 2)
Microphone	Auto sensitivity (A)
Destination	CF card slot
Interval timer shooting (☐ 189)	Reset <sup>3</sup>

- 1 Default settings can be restored using **Reset shooting menu** (☐ 256).  
With the exception of **Multiple exposure** and **Interval timer shooting**, only settings in the current shooting menu bank will be reset.
- 2 Applies to all banks. **Reset shooting menu** can not be selected while shooting is in progress.
- 3 Applies to all banks. Shooting ends when reset is performed.

## ■ Custom Settings Menu Defaults \*

	Option	Default
a1	AF-C priority selection (☐ 263)	Release
a2	AF-S priority selection (☐ 264)	Focus
a3	Dynamic AF area (☐ 264)	9 points
a4	Focus tracking with lock-on (☐ 266)	Normal
a5	AF activation (☐ 266)	Shutter/AF-ON
a6	AF point illumination (☐ 266)	Auto
a7	Focus point wrap-around (☐ 267)	No wrap
a8	AF point selection (☐ 267)	51 points
a9	Built-in AF-assist illuminator (☐ 268)	On
a10	AF-ON for MB-D10 (☐ 269)	AF-ON
b1	ISO sensitivity step value (☐ 270)	1/3 step
b2	EV steps for exposure cntrl. (☐ 270)	1/3 step
b3	Exp comp/fine tune (☐ 270)	1/3 step
b4	Easy exposure compensation (☐ 271)	Off
b5	Center-weighted area (☐ 272)	∅ 8 mm
b6	Fine tune optimal exposure (☐ 272)	
	Matrix metering	0
	Center-weighted metering	0
	Spot metering	0



	<b>Option</b>	<b>Default</b>
c1	Shutter-release button AE-L (☐ 273)	Off
c2	Auto meter-off delay (☐ 273)	6 s
c3	Self-timer (☐ 273)	10 s
c4	Monitor off delay (☐ 274)	
	Playback	10 s
	Menus	20 s
	Information display	10 s
	Image review	4 s
d1	Beep (☐ 275)	High
d2	Viewfinder grid display (☐ 275)	Off
d3	Viewfinder warning display (☐ 275)	On
d4	Screen tips (☐ 276)	On
d5	CL mode shooting speed (☐ 276)	3 fps
d6	Max. continuous release (☐ 276)	100
d7	File number sequence (☐ 277)	On
d8	Information display (☐ 278)	Auto
d9	LCD illumination (☐ 278)	Off
d10	Exposure delay mode (☐ 278)	Off
d11	MB-D10 battery type (☐ 279)	LR6 (AA alkaline)
d12	Battery order (☐ 280)	Use MB-D10 batteries first
e1	Flash sync speed (☐ 281)	1/250 s
e2	Flash shutter speed (☐ 282)	1/60 s
e3	Flash cntrl for built-in flash (☐ 283)	TTL
e4	Modeling flash (☐ 289)	On
e5	Auto bracketing set (☐ 289)	AE & flash
e6	Auto bracketing (Mode M) (☐ 290)	Flash/speed
e7	Bracketing order (☐ 290)	MTR > under > over
f1	☼ switch (☐ 291)	LCD backlight (☼)
f2	Multi selector center button (☐ 291)	
	Shooting mode	Select center focus point
	Playback mode	Thumbnail on/off
f3	Multi selector (☐ 292)	Do nothing
f4	Photo info/playback (☐ 292)	Info ⦿/Playback ⦿





	Option	Default
f5	Assign Fn button (☐ 292)	
	Fn button press	None
	Fn button + dials	Auto bracketing
f6	Assign preview button (☐ 296)	
	Preview button press	Preview
	Preview + command dials	None
f7	Assign AE-L/AF-L button (☐ 296)	
	AE-L/AF-L button press	AE/AF lock
	AE-L/AF-L + command dials	None
f8	Customize command dials (☐ 297)	
	Reverse rotation (☐ 297)	No
	Change main/sub (☐ 297)	Off
	Aperture setting (☐ 297)	Sub-command dial
	Menus and playback (☐ 298)	Off
f9	Release button to use dial (☐ 298)	No
f10	No memory card? (☐ 299)	Enable release
f11	Reverse indicators (☐ 299)	

\* Defaults for the current Custom Settings bank can be restored using **Reset custom settings** (☐ 262).

## ■ Setup Menu Defaults

Option	Default
LCD brightness (☐ 301)	0
Clean image sensor	
Clean at startup/shutdown	Cleaning off
HDMI (☐ 302)	Auto
Time zone and date (☐ 302)	
Daylight saving time	Off
Auto image rotation (☐ 304)	On
Image authentication (☐ 308)	Off
GPS (☐ 201)	
Auto meter off	Enable
Eye-Fi upload (☐ 313)	Enable



# Exposure Program

The exposure program for programmed auto is shown in the following graph:

— ISO 200; lens with maximum aperture of f/1.4 and minimum aperture of f/16 (e.g., AF 50mm f/1.4 D)

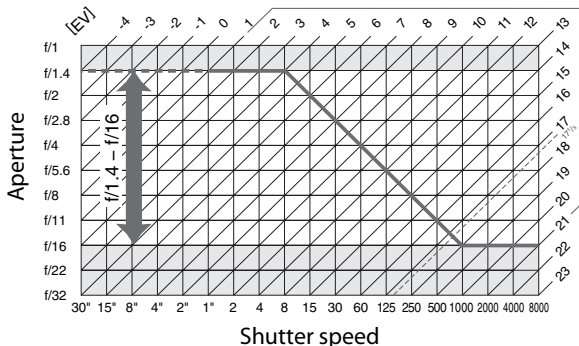

The maximum and minimum values for EV vary with ISO sensitivity; the above graph assumes an ISO sensitivity of ISO 200 equivalent. When matrix metering is used, values over  $17\frac{1}{3}$  EV are reduced to  $17\frac{1}{3}$  EV.



# Troubleshooting

If the camera fails to function as expected, check the list of common problems below before consulting your retailer or Nikon representative.

## ■ ■ Display

---

**Viewfinder is out of focus:** Adjust viewfinder focus or use optional diopter adjustment lenses (☞ 36, 353).

---

**Viewfinder is dark:** Insert a fully-charged battery (☞ 22, 37).

---

**Displays turn off without warning:** Choose longer delays for Custom Setting c2 (**Auto meter-off delay**) or c4 (**Monitor off delay**) (☞ 273, 274).

---

**Unusual characters displayed in control panel:** See “A Note on Electronically-Controlled Cameras,” below.

---

**Displays in control panel or viewfinder are unresponsive and dim:** The response times and brightness of these displays varies with temperature.

---

**Fine lines are visible around active focus point or display turns red when focus point is highlighted:** These phenomena are normal for this type of viewfinder and do not indicate a malfunction.

---

### **A Note on Electronically-Controlled Cameras**

In extremely rare instances, unusual characters may appear in the control panel and the camera may stop functioning. In most cases, this phenomenon is caused by a strong external static charge. Turn the camera off, remove and replace the battery, and turn the camera on again, or, if you are using an AC adapter (available separately), disconnect and reconnect the adapter and turn the camera on again. In the event of continued malfunction, contact your retailer or Nikon-authorized service representative. Note that disconnecting the power source as described above may result in loss of any data not recorded to the memory card at the time the problem occurred. Data already recorded to the card will not be affected.



## ■ Shooting

---

**Camera takes time to turn on:** Delete files or folders.

---

**Shutter-release disabled:**

- Memory card is full or not inserted (☐ 31, 38).
- Memory card is locked (SD cards only; ☐ 35).
- CPU lens with aperture ring attached but aperture not locked at highest f-number. If **fE E** is displayed in control panel, select **Aperture ring** for Custom Setting f8 (**Customize command dials**) > **Aperture setting** to use lens aperture ring to adjust aperture (☐ 297).
- Exposure mode **S** selected with **b u i b** selected for shutter speed (☐ 380).

---

**Camera is slow to respond to shutter-release button:** Select **Off** for Custom Setting d10 (**Exposure delay mode**; ☐ 278).

---

**Photos are out of focus:**

- Rotate focus-mode selector to **S** or **C** (☐ 74).
- Camera unable to focus using autofocus: use manual focus or focus lock (☐ 80, 83).
- **Tripod** selected in live view: camera will not focus when shutter-release button is pressed halfway. Use **AF-ON** button (☐ 50).

---

**Full range of shutter speeds not available:** Flash in use. Flash sync speed can be selected using Custom Setting e1 (**Flash sync speed**); when using optional SB-900, SB-800, SB-600, or SB-R200 flash unit, choose **1/320 s (Auto FP)** or **1/250 s (Auto FP)** for full range of shutter speeds (☐ 281).

---

**Focus does not lock when shutter-release button is pressed halfway:** Camera is in focus mode **C**: use **AE-L/AF-L** button to lock focus (☐ 81).

---

**Can not select focus point:**

- Unlock focus selector lock (☐ 78).
- Auto-area AF selected for focus mode: choose another mode (☐ 76).
- Camera is in playback mode (☐ 203).
- Menus are in use (☐ 243).
- Press shutter-release button halfway to turn monitor off or activate exposure meters (☐ 39).

---

**Image size can not be changed:** **Image quality** set to **NEF (RAW)** (☐ 68).

---

**Camera is slow to record photos:** Turn long exposure noise reduction off (☐ 258).

---



---

**Beep does not sound:**

- **Off** is selected for Custom Setting d1 (**Beep**; [ 275]).
- Camera is in quiet shutter-release mode ([ 86]).
- Camera is in focus mode **C** or **M** ([ 74]).
- **Release** is selected for Custom Setting a2 (**AF-S priority selection**; [ 264]).
- Movie is being recorded ([ 58]).

---

**Photos not recorded in live view mode:**

- Sound of mirror clicking down when shutter-release button was pressed halfway in hand-held mode was mistaken for sound of shutter ([ 54]).
- Unless **Release** is chosen for Custom Setting a2 (**AF-S priority selection**), shutter release is disabled if camera is unable to focus when focus mode **S** is selected in hand-held mode ([ 54, 264]).

---

**Randomly-spaced bright pixels, reddish areas, or other irregularities (“noise”) appear in photos:**

- Choose lower ISO sensitivity or use high ISO noise reduction ([ 96, 259]).
- Shutter speed is slower than 8 s: use long exposure noise reduction ([ 258]).
- Reddish areas or other artifacts appear in long time-exposures: turn long exposure noise reduction on when shooting at a shutter speed of “**h u i h**” ([ 258]).

---

**AF-assist illuminator does not light:**

- Camera is in focus mode **C** ([ 74]).
- Center focus point is not selected for single-point AF or dynamic-area AF ([ 76]).
- **Off** selected for Custom Setting a9 (**Built-in AF-assist illuminator**) ([ 268]).
- Illuminator has turned off automatically. Illuminator may become hot with continued use; wait for lamp to cool down.

---

**Photos are blotched or smeared:**

- Clean lens.
- Clean low-pass filter ([ 358]).

---

**Colors are unnatural:**

- Adjust white balance to match light source ([ 134]).
- Adjust **Set Picture Control** settings ([ 154]).

---

**Can not measure white balance:** Subject is too dark or too bright ([ 145]).

---

**Image can not be selected as source for preset white balance:** Image was not created with D300S ([ 148]).

---



---

**White balance bracketing unavailable:**

- NEF (RAW) or NEF+JPEG image quality option selected for image quality (☞ 68).
- Multiple exposure mode is in effect (☞ 187).

---

**Effects of Picture Control differ from image to image:** A (auto) is selected for sharpening, contrast, or saturation. For consistent results over a series of photographs, choose a setting other than A (auto) (☞ 158).

---

**Can not adjust Picture Control contrast or brightness:** Contrast and brightness can not be adjusted when Active D-Lighting is on. Turn Active D-Lighting off.

---

**Metering can not be changed:** Live view is in progress, autoexposure lock is in effect, or movie is being recorded (☞ 54, 61, 116).

---

**Exposure compensation can not be used:** Choose exposure mode *P*, *S*, or *A* (☞ 118).

---

**Only one shot taken each time shutter-release button is pressed in continuous shooting mode:** Lower built-in flash (☞ 173).

---

**Sound is not recorded with movies:**

- **Microphone off** is selected for **Movie settings > Microphone**.
- External microphone is disconnected during recording.

---

## ■■ Playback

---

**Flashing areas, shooting data, or graphs appear on images:** Press ▲ or ▼ to choose photo information displayed, or change settings for **Display mode** (☞ 207, 247).

---

**NEF (RAW) image is not played back:** Photo was taken at image quality of NEF + JPEG (☞ 69).

---

**Can not view pictures recorded with other cameras:** Pictures recorded with other makes of camera may not be displayed correctly.

---

**Some photos are not displayed during playback:** Select **All** for **Playback folder** (☞ 245).

---

**“Tall” (portrait) orientation photos are displayed in “wide” (landscape) orientation:**

- Select **On** for **Rotate tall** (☞ 251).
- Photo was taken with **Off** selected for **Auto image rotation** (☞ 304).
- Photo is displayed in image review (☞ 206).
- Camera was pointed up or down when photo was taken (☞ 304).

---

**Can not delete photo:** Photo is protected. Remove protection (☞ 219).

---

**Can not retouch picture:** Picture was not created with D300S (☞ 316).

---

**Message is displayed stating that no images are available for playback:** Select **All** for **Playback folder** (☞ 245).

---

**Can not change print order:**

- Memory card is full: delete photos (☐ 38, 220).
- Memory card is locked (SD cards only; ☐ 35).

---

**Can not select photo for printing:** Photo is in NEF (RAW) format. Create JPEG copy using **NEF (RAW) processing** or transfer to computer and print using ViewNX (supplied) or Capture NX 2 (available separately).

---

**Can not print photos:**

- Memory card is locked (SD cards only; ☐ 35).
- NEF (RAW) photos can not be printed by direct USB connection. Create JPEG copy using **NEF (RAW) processing** (☐ 327) or transfer to computer and print using ViewNX (supplied) or Capture NX 2 (available separately; ☐ 355).

---

**Photo is not displayed on TV:** Choose correct video mode (☐ 301).

---

**Photo is not displayed on high-definition video device:** Confirm that HDMI cable (available separately) is connected (☐ 241).

---

**NEF (RAW) photos not displayed in Capture NX:** Update to Capture NX 2 (☐ 355).

---

**Image Dust Off option in Capture NX 2 does not have desired effect:** Image sensor cleaning changes the position of dust on the low-pass filter. Dust off reference data recorded before image sensor cleaning is performed can not be used with photographs taken after image sensor cleaning is performed. Dust off reference data recorded after image sensor cleaning is performed can not be used with photographs taken before image sensor cleaning is performed (☐ 305).

---

**Computer displays NEF (RAW) images differently from camera:** Third-party software does not display effects of Picture Controls or active D-Lighting. Use ViewNX (supplied) or optional Nikon software such as Capture NX 2 (available separately).

---

**Can not copy pictures to computer using Nikon Transfer:** Operating system is not supported (☐ 224). Transfer pictures from the memory card using a card reader or card slot.

---

**■ Miscellaneous**

---

**Date of recording is not correct:** Set camera clock (☐ 29).

---







**Menu item can not be selected:** Some options are not available at certain combinations of settings or when no memory card is inserted. Note that

---

**Battery info** option is not available when camera is powered by an optional AC adapter (☐ 307).

# Error Messages

This section lists the indicators and error messages that appear in the viewfinder, control panel, and monitor.









Indicator		Problem	Solution	
Control panel	Viewfinder			
<b>fE E</b> (blinks)		Lens aperture ring is not set to minimum aperture.	Set ring to minimum aperture (largest f-number).	27
		Low battery.	Ready a fully-charged spare battery.	37
 (blinks)	 (blinks)	<ul style="list-style-type: none"> <li>• Battery exhausted.</li> <li>• Battery can not be used.</li> <li>• An extremely exhausted rechargeable Li-ion battery or a third-party battery is inserted either in the camera or in the optional MB-D10 battery pack.</li> </ul>	<ul style="list-style-type: none"> <li>• Recharge or replace battery.</li> <li>• Contact Nikon-authorized service representative.</li> <li>• Replace the battery, or recharge the battery if the rechargeable Li-ion battery is exhausted.</li> </ul>	xxiii, 22, 24
 (blinks)	—	Camera clock is not set.	Set camera clock.	29











Indicator		Problem	Solution	📖
Control panel	View-finder			
	<b>ΔF</b>	No lens attached, or non-CPU lens attached without specifying maximum aperture. Aperture shown in stops from maximum aperture.	Aperture value will be displayed if maximum aperture is specified.	195
—	● (blinks)	Camera unable to focus using autofocus.	Focus manually.	83
	<b>⌘ i</b>	Subject too bright; photo will be overexposed.	<ul style="list-style-type: none"> <li>• Use a lower ISO sensitivity</li> <li>• In exposure mode: <ul style="list-style-type: none"> <li><b>P</b> Use optional ND filter</li> <li><b>S</b> Increase shutter speed</li> <li><b>A</b> Choose a smaller aperture (larger f-number)</li> </ul> </li> </ul>	96 354 108 109



Indicator		Problem	Solution	📖
Control panel	View-finder			
		Subject too dark; photo will be underexposed.	<ul style="list-style-type: none"> <li>• Use a higher ISO sensitivity</li> <li>• In exposure mode: <ul style="list-style-type: none"> <li> Use flash</li> <li> Lower shutter speed</li> <li> Choose a larger aperture (smaller f-number)</li> </ul> </li> </ul>	96  171 108  109
	 (blinks)	 selected in exposure mode  .	Change shutter speed or select manual exposure mode.	108, 111
 (blinks)	 (blinks)	Optional flash unit that does not support i-TTL flash control attached and set to TTL.	Change flash mode setting on optional flash unit.	350















Indicator		Problem	Solution	📖
Control panel	View-finder			
—	 (blinks)	If indicator blinks for 3s after flash fires, photo may be underexposed.	Check photo in monitor; if underexposed, adjust settings and try again.	172
<b>Full</b>  CF/  SD (blinks)	<b>Full</b> (blinks)	Memory insufficient to record further photos at current settings, or camera has run out of file or folder numbers.	<ul style="list-style-type: none"> <li>• Reduce quality or size.</li> <li>• Delete photographs.</li> <li>• Insert new memory card.</li> </ul>	68, 71 220 31
<b>Err</b> (blinks)		Camera malfunction.	Release shutter. If error persists or appears frequently, consult Nikon-authorized service representative.	—

 **The CF and SD Icons**

These icons flash to show the card affected.



Indicator		Problem	Solution	
Monitor	Control panel			
<b>No memory card.</b>	{ - E - }	Camera cannot detect memory card.	Turn camera off and confirm that card is correctly inserted.	31
<b>This memory card cannot be used. Card may be damaged. Insert another card.</b>	   (blinks)	<ul style="list-style-type: none"> <li>• Error accessing memory card.</li> <li>• Unable to create new folder.</li> </ul>	<ul style="list-style-type: none"> <li>• Use Nikon-approved card.</li> <li>• Check that contacts are clean. If card is damaged, contact retailer or Nikon representative.</li> <li>• Delete files or insert new memory card.</li> </ul>	393 — 31, 220
	  (blinks)	Camera can not control Eye-Fi card.	<ul style="list-style-type: none"> <li>• Check that Eye-Fi card firmware is up to date.</li> <li>• Copy files on Eye-Fi card to a computer or other device and format card, or insert new card.</li> </ul>	313 31, 33
<b>Memory card is locked. Slide lock to “write” position.</b>	  (blinks)	SD memory card is locked (write protected).	Slide card write-protect switch to “write” position.	35
<b>This card is not formatted. Format the card.</b>	   (blinks)	Memory card has not been formatted for use in camera.	Format memory card or insert new memory card.	31, 34



Indicator		Problem	Solution	
Monitor	Control panel			
<b>Failed to update flash unit firmware. Flash cannot be used. Contact a Nikon-authorized service representative.</b>	—	Firmware for flash unit mounted on camera was not updated correctly.	Contact a Nikon-authorized service representative.	—
<b>Folder contains no images.</b>	—	No images on memory card or in folder(s) selected for playback.	Select folder containing images from <b>Playback folder</b> menu or insert different memory card.	31, 245
<b>All images are hidden.</b>	—	All photos in current folder are hidden.	No images can be played back until another folder has been selected or <b>Hide image</b> used to allow at least one image to be displayed.	245
<b>File does not contain image data.</b>	—	File has been created or modified using a computer or different make of camera, or file is corrupt.	File can not be played back on camera.	—
<b>Cannot select this file.</b>	—	Selected image can not be retouched.	Images created with other devices can not be retouched.	316



Indicator		Problem	Solution	
Monitor	Control panel			
<b>This movie can not be edited.</b>	—	The selected movie can not be edited.	<ul style="list-style-type: none"> <li>• Movies created with other devices can not be edited.</li> <li>• Movies must be at least two seconds long.</li> </ul>	— 65
<b>Check printer.</b>	—	Printer error.	Check printer. To resume, select <b>Continue</b> (if available).	229*
<b>Check paper.</b>	—	Paper in printer is not of selected size.	Insert paper of correct size and select <b>Continue</b> .	229*
<b>Paper jam.</b>	—	Paper is jammed in printer.	Clear jam and select <b>Continue</b> .	229*
<b>Out of paper.</b>	—	Printer is out of paper.	Insert paper of selected size and select <b>Continue</b> .	229*
<b>Check ink supply.</b>	—	Ink error.	Check ink. To resume, select <b>Continue</b> .	229*
<b>Out of ink.</b>	—	Printer is out of ink.	Replace ink and select <b>Continue</b> .	229*

\* See printer manual for more information.



# Specifications

## ■ Nikon D300S Digital Camera

Type	
Type	Single-lens reflex digital camera
Lens mount	Nikon F mount (with AF coupling and AF contacts)
Effective picture angle	Approx. 1.5 × lens focal length (Nikon DX format)
Effective pixels	
Effective pixels	12.3 million
Image sensor	
Image sensor	23.6 × 15.8 mm CMOS sensor
Total pixels	13.1 million
Dust-reduction System	Image sensor cleaning, Image Dust Off reference data (requires optional Capture NX 2 software)
Storage	
Image size (pixels)	<ul style="list-style-type: none"><li>• 4,288 × 2,848 (L)</li><li>• 3,216 × 2,136 (M)</li><li>• 2,144 × 1,424 (S)</li></ul>
File format	<ul style="list-style-type: none"><li>• <b>NEF (RAW)</b>: 12 or 14 bit, lossless compressed, compressed, or uncompressed</li><li>• <b>TIFF (RGB)</b></li><li>• <b>JPEG</b>: JPEG-Baseline compliant with fine (approx. 1 : 4), normal (approx. 1 : 8), or basic (approx. 1 : 16) compression (<b>Size priority</b>); <b>Optimal quality</b> compression available</li><li>• <b>NEF (RAW)+JPEG</b>: Single photograph recorded in both NEF (RAW) and JPEG formats</li></ul>
Picture Control System	Can be selected from Standard, Neutral, Vivid, Monochrome; selected Picture Control can be modified; storage for custom Picture Controls
Media	Type I CompactFlash memory cards (UDMA compliant); SD (Secure Digital) memory cards, SDHC compliant



Storage	
<b>Dual card slots</b>	Either card can be used for primary or backup storage or for separate storage of copies created using NEF+JPEG; pictures can be copied between cards.
<b>File system</b>	DCF (Design Rule for Camera File System) 2.0, DPOF (Digital Print Order Format), Exif 2.21 (Exchangeable Image File Format for Digital Still Cameras), PictBridge

Viewfinder	
<b>Viewfinder</b>	Eye-level pentaprism single-lens reflex viewfinder
<b>Frame coverage</b>	Approx. 100% horizontal and 100% vertical
<b>Magnification</b>	Approx. $0.94 \times$ (50 mm f/1.4 lens at infinity, $-1.0 \text{ m}^{-1}$ )
<b>Eyepoint</b>	19.5 mm ( $-1.0 \text{ m}^{-1}$ )
<b>Diopter adjustment</b>	$-2$ – $+1 \text{ m}^{-1}$
<b>Focusing screen</b>	Ships with type B BriteView Clear Matte Mark II screen with AF area brackets (framing grid can be displayed)
<b>Reflex mirror</b>	Quick return
<b>Depth-of-field preview</b>	When depth of field preview button is pressed, lens aperture is stopped down to value selected by user ( $M$ and $M$ modes) or by camera ( $P$ and $S$ modes)
<b>Lens aperture</b>	Instant return, electronically controlled

Lens	
<b>Compatible lenses</b>	<ul style="list-style-type: none"> <li>• <b>DX AF NIKKOR:</b> All functions supported</li> <li>• <b>Type G or D AF NIKKOR:</b> All functions supported (PC Micro-NIKKOR does not support some functions). IX NIKKOR lenses not supported.</li> <li>• <b>Other AF NIKKOR:</b> All functions supported except 3D color matrix metering II. Lenses for F3AF not supported.</li> <li>• <b>AI-P NIKKOR:</b> All functions supported except 3D color matrix metering II</li> <li>• <b>Non-CPU:</b> Can be used in exposure modes <math>M</math> and <math>M</math>; color matrix metering and aperture value display supported if user provides lens data (AI lenses only)</li> </ul> <p>Electronic rangefinder can be used if maximum aperture is f/5.6 or faster.</p>



Shutter	
Type	Electronically-controlled vertical-travel focal-plane shutter
Speed	$1/8000$ – 30 s in steps of $1/3$ , $1/2$ , or 1 EV, bulb, X250
Flash sync speed	$X=1/250$ s; synchronizes with shutter at $1/320$ s or slower (flash range drops at speeds between $1/250$ and $1/320$ s)
Release	
Release mode	<b>S</b> (single frame), <b>CL</b> (continuous low speed), <b>CH</b> (continuous high speed), <b>Q</b> (quiet shutter-release), <b>⌚</b> (self-timer), <b>MUP</b> (mirror up)
Approximate frame advance rate (CIPA guidelines)	<ul style="list-style-type: none"> <li>• With <b>EN-EL3e</b>: 1–7 fps (<b>CL</b>) or 7 fps (<b>CH</b>)</li> <li>• With optional <b>MB-D10 multi-power battery pack and EN-EL4a</b>: 1–7 (<b>CL</b>) or 8 fps (<b>CH</b>)</li> </ul>
Self-timer	Can be selected from 2, 5, 10, and 20 s duration
Exposure	
Metering	TTL exposure metering using 1,005-pixel RGB sensor
Metering method	<ul style="list-style-type: none"> <li>• <b>Matrix</b>: 3D color matrix metering II (type G and D lenses); color matrix metering II (other CPU lenses); color matrix metering available with non-CPU lenses if user provides lens data</li> <li>• <b>Center-weighted</b>: Weight of 75% given to 8 mm circle in center of frame. Diameter of circle can be changed to 6, 10, or 13 mm, or weighting can be based on average of entire frame (fixed at 8 mm when non-CPU lens is used)</li> <li>• <b>Spot</b>: Meters 3 mm circle (about 2% of frame) centered on selected focus point (on center focus point when non-CPU lens is used)</li> </ul>
Range (ISO 100, f/1.4 lens, 20 °C/68 °F)	<ul style="list-style-type: none"> <li>• <b>Matrix or center-weighted metering</b>: 0–20 EV</li> <li>• <b>Spot metering</b>: 2–20 EV</li> </ul>
Exposure meter coupling	Combined CPU and AI
Exposure mode	Programmed auto with flexible program ( <b>P</b> ); shutter-priority auto ( <b>S</b> ); aperture-priority auto ( <b>A</b> ); manual ( <b>M</b> )
Exposure compensation	–5 – +5 EV in increments of $1/3$ , $1/2$ , or 1 EV
Exposure bracketing	2–9 frames in steps of $1/3$ , $1/2$ , $2/3$ , or 1 EV



Exposure	
Flash bracketing	2–9 frames in steps of $\frac{1}{3}$ , $\frac{1}{2}$ , $\frac{2}{3}$ , or 1 EV
White balance bracketing	2–9 frames in steps of 1, 2, or 3
ADL bracketing	2 frames using selected value for one frame or 3–5 frames using preset values for all frames
Exposure lock	Luminosity locked at detected value with <b>AE-L/AF-L</b> button
ISO sensitivity (Recommended Exposure Index)	ISO 200 – 3200 in steps of $\frac{1}{3}$ , $\frac{1}{2}$ , or 1 EV. Can also be set to approx. 0.3, 0.5, 0.7, or 1 EV (ISO 100 equivalent) below ISO 200 or to approx. 0.3, 0.5, 0.7, or 1 EV (ISO 6400 equivalent) above ISO 3200; auto ISO sensitivity control available
Active D-Lighting	Can be selected from <b>Auto, Extra high, High, Normal, Low, or Off</b>

Focus	
Autofocus	Nikon Multi-CAM 3500DX autofocus sensor module with TTL phase detection, fine-tuning, 51 focus points (including 15 cross-type sensors), and AF-assist illuminator (range approx. 0.5–3 m/1 ft. 8 in.–9 ft. 10 in.)
Detection range	–1 – +19 EV (ISO 100, 20 °C/68 °F)
Lens servo	<ul style="list-style-type: none"> <li>• <b>Autofocus (AF):</b> Single-servo AF (<b>S</b>); continuous-servo AF (<b>C</b>); predictive focus tracking automatically activated according to subject status</li> <li>• <b>Manual (MF):</b> Electronic range finding supported</li> </ul>
Focus point	Can be selected from 51 or 11 focus points
AF-area mode	Single-point AF, dynamic-area AF, auto-area AF
Focus lock	Focus can be locked by pressing shutter-release button halfway (single-servo AF) or by pressing <b>AE-L/AF-L</b> button

Flash	
Built-in flash	Manual pop-up with button release and a Guide Number of 17/56 (m/ft., ISO 200, 20 °C/68 °F; GN at ISO 100 is 12/39)



Flash	
<b>Flash control</b>	<ul style="list-style-type: none"> <li>• <b>TTL:</b> i-TTL balanced fill-flash and standard i-TTL flash for digital SLR using 1,005-pixel RGB sensor are available with built-in flash and SB-900, SB-800, SB-600, or SB-400</li> <li>• <b>Auto aperture:</b> Available with SB-900 or SB-800 and CPU lens</li> <li>• <b>Non-TTL auto:</b> Supported flash units include SB-900, SB-800, SB-28, SB-27, and SB-22S</li> <li>• <b>Distance-priority manual:</b> Available with SB-900 and SB-800</li> </ul>
<b>Flash mode</b>	Front curtain sync, slow sync, rear-curtain sync, red-eye reduction, red-eye reduction with slow sync
<b>Flash compensation</b>	-3 – +1 EV in increments of $\frac{1}{3}$ , $\frac{1}{2}$ , or 1 EV
<b>Flash-ready indicator</b>	Lights when built-in flash or optional flash unit such as SB-900, SB-800, SB-600, SB-400, SB-80DX, SB-28DX, or SB-50DX is fully charged; blinks after flash is fired at full output
<b>Accessory shoe</b>	ISO 518 hot-shoe with sync and data contacts and safety lock
<b>Nikon Creative Lighting System (CLS)</b>	Advanced Wireless Lighting supported with built-in flash, SB-900, SB-800, or SU-800 as commander and SB-900, SB-800, SB-600, or SB-R200 as remotes; Auto FP High-Speed Sync and modeling illumination supported with all CLS-compatible flash units except SB-400; Flash Color Information Communication and FV lock supported with all CLS-compatible flash units
<b>Sync terminal</b>	ISO 519 sync terminal with locking thread
White balance	
<b>White balance</b>	Auto, incandescent, fluorescent (7 types), direct sunlight, flash, cloudy, shade, preset manual (up to 5 values can be stored), choose color temperature (2500 K–10000 K), all with fine tuning.
Live view	
<b>Modes</b>	Tripod, hand-held
<b>Autofocus</b>	<ul style="list-style-type: none"> <li>• <b>Tripod:</b> Contrast-detect AF anywhere in frame</li> <li>• <b>Hand-held:</b> Phase-detection TTL AF with 51 focus points (including 15 cross-type sensors)</li> </ul>



Movie	
<b>Frame size (pixels)</b>	<ul style="list-style-type: none"> <li>• 1,280 × 720/24 fps</li> <li>• 640 × 424/24 fps</li> <li>• 320 × 216/24 fps</li> </ul>
<b>File format</b>	AVI
<b>Compression</b>	Motion-JPEG
<b>Audio</b>	Microphone sensitivity can be adjusted

Monitor	
<b>Monitor</b>	3-in., 921k-dot (VGA), low-temperature polysilicon TFT LCD with 170 ° viewing angle, 100% frame coverage, and brightness adjustment

Playback	
<b>Playback</b>	Full-frame and thumbnail (4, 9, or 72 images) playback with playback zoom, movie playback, slide show, highlights, histogram display, auto image rotation, and image comment (up to 36 characters)

Interface	
<b>USB</b>	Hi-Speed USB
<b>Video output</b>	Can be selected from NTSC and PAL; images can be displayed on external device while camera monitor is on
<b>HDMI output</b>	Type C HDMI connector; camera monitor turns off when HDMI cable is connected
<b>Audio input</b>	Stereo mini-pin jack (3.5 mm diameter)
<b>Ten-pin remote terminal</b>	Can be used to connect optional remote control, GP-1 GPS unit, or GPS device compliant with NMEA0183 version 2.01 or 3.01 (requires optional MC-35 GPS adapter cord and cable with D-sub 9-pin connector)

Supported languages	
<b>Supported languages</b>	Chinese (Simplified and Traditional), Danish, Dutch, English, Finnish, French, German, Italian, Japanese, Korean, Norwegian, Polish, Portuguese, Russian, Spanish, Swedish

Power source	
<b>Battery</b>	One rechargeable Li-ion EN-EL3e battery

Power source	
<b>Battery pack</b>	Optional MB-D10 multi-power battery pack with one rechargeable Nikon EN-EL3e, EN-EL4a, or EN-EL4 Li-ion battery or eight AA alkaline, NiMH, lithium, or nickel-manganese batteries; EN-EL4a/EN-EL4 and AA batteries available separately; A BL-3 battery-chamber cover is required when using EN-EL4a or EN-EL4 batteries.
<b>AC adapter</b>	EH-5a or EH-5 AC adapter (available separately)

Tripod socket	
<b>Tripod socket</b>	1/4 in. (ISO 1222)

Dimensions/weight	
<b>Dimensions (W × H × D)</b>	Approx. 147 × 114 × 74 mm (5.8 × 4.5 × 2.9 in.)
<b>Weight</b>	Approx. 840 g (1 lb. 14 oz.) without battery, memory card, body cap, or monitor cover

Operating environment	
<b>Temperature</b>	0–40 °C (+32–104 °F)
<b>Humidity</b>	Less than 85% (no condensation)

- Unless otherwise stated, all figures are for a camera with a fully-charged battery operating at an ambient temperature of 20 °C (68 °F).
- Nikon reserves the right to change the specifications of the hardware and software described in this manual at any time and without prior notice. Nikon will not be held liable for damages that may result from any mistakes that this manual may contain.

MH-18a quick charger	
<b>Rated input</b>	AC 100–240 V (50/60 Hz)
<b>Rated output</b>	DC 8.4 V/900 mA
<b>Supported batteries</b>	Nikon EN-EL3e rechargeable Li-ion battery
<b>Charging time</b>	Approx. 2 hours and 15 minutes when battery is fully discharged
<b>Operating temperature</b>	0–40 °C (+32–104 °F)
<b>Dimensions (W × H × D)</b>	Approx. 90 × 35 × 58 mm (3.5 × 1.4 × 2.3 in.)
<b>Length of cord</b>	Approx. 1800 mm (5 ft. 11 in.)
<b>Weight</b>	Approx. 80 g (2.8 oz.), excluding power cable



### EN-EL3e rechargeable Li-ion battery

Type	Rechargeable lithium-ion battery
Rated capacity	7.4 V/1500 mAh
Dimensions (W × H × D)	Approx. 39.5 × 56 × 21 mm (1.6 × 2.2 × 0.8 in.)
Weight	Approx. 80 g (2.8 oz.), excluding terminal cover

#### Supported Standards

- **DCF Version 2.0:** The Design Rule for Camera File System (DCF) is a standard widely used in the digital camera industry to ensure compatibility among different makes of camera.
- **DPOF:** Digital Print Order Format (DPOF) is an industry-wide standard that allows pictures to be printed from print orders stored on the memory card.
- **Exif version 2.21:** The camera supports Exif (Exchangeable Image File Format for Digital Still Cameras) version 2.21, a standard in which information stored with photographs is used for optimal color reproduction when the images are output on Exif-compliant printers.
- **PictBridge:** A standard developed through cooperation with the digital camera and printer industries, allowing photographs to be output directly to a printer without first transferring them to a computer.
- **HDMI:** High-Definition Multimedia Interface is a standard for multimedia interfaces used in consumer electronics and AV devices capable of transmitting audiovisual data and control signals to HDMI-compliant devices via a single cable connection.

# Approved Memory Cards

The following cards have been tested and approved for use in the D300S.

## • Type 1 CompactFlash memory cards

SanDisk	Extreme IV	SDCFX4	2 GB, 4 GB, 8 GB, 16 GB
	Extreme III	SDCFX3	1 GB, 2 GB, 4 GB, 8 GB, 16 GB
	Ultra II	SDCFH	1 GB, 2 GB, 4 GB, 8 GB
	Standard	SDCFB	1 GB, 2 GB, 4 GB
Lexar Media	Professional UDMA	300 ×	2 GB, 4 GB, 8 GB
	Professional	233 ×	2 GB, 4 GB, 8 GB
		133 ×	1 GB, 2 GB, 4 GB
	Platinum II	80 ×	1 GB, 2 GB, 4 GB, 8 GB, 16 GB
		60 ×	4 GB

## • SD memory cards\*

SanDisk	512 MB, 1 GB, 2 GB <sup>†</sup> , 4 GB <sup>‡</sup> , 8 GB <sup>‡</sup> , 16 GB <sup>‡</sup>
Toshiba	512 MB, 1 GB, 2 GB <sup>†</sup> , 4 GB <sup>‡</sup> , 8 GB <sup>‡</sup> , 16 GB <sup>‡</sup> , 32 GB <sup>‡</sup>
Panasonic	512 MB, 1 GB, 2 GB <sup>†</sup> , 4 GB <sup>‡</sup> , 8 GB <sup>‡</sup> , 16 GB <sup>‡</sup> , 32 GB <sup>‡</sup>
Lexar Media	512 MB, 1 GB, 2 GB <sup>†</sup> , 4 GB <sup>‡</sup> , 8 GB <sup>‡</sup>
	Platinum II: 512 MB, 1 GB, 2 GB <sup>†</sup> , 4 GB <sup>‡</sup> , 8 GB <sup>‡</sup> , 16 GB <sup>‡</sup>
	Professional: 1 GB, 2 GB <sup>†</sup> , 4 GB <sup>‡</sup> , 8 GB <sup>‡</sup>

\* All cards listed can be used, regardless of speed.

<sup>†</sup> If card will be used with card reader or other device, check that device supports 2GB cards.

<sup>‡</sup> SDHC compliant. If card will be used with card reader or other device, check that device supports SDHC.



Other cards have not been tested. For more details on the above cards, please contact the manufacturer.



# Memory Card Capacity

The following table shows the approximate number of pictures that can be stored on a 4 GB SanDisk Extreme IV (SDCFX4) card at different image quality and size settings.

Image quality	Image size	File size <sup>1</sup>	No. of images <sup>1</sup>	Buffer capacity <sup>2</sup>
NEF (RAW), Lossless compressed, 12-bit	—	12.1 MB	197	18
NEF (RAW), Lossless compressed, 14-bit <sup>3</sup>	—	14.9 MB	151	30
NEF (RAW), Compressed, 12-bit	—	10.5 MB	270	20
NEF (RAW), Compressed, 14-bit <sup>3</sup>	—	13.0 MB	223	45
NEF (RAW), Uncompressed, 12-bit	—	19.5 MB	197	17
NEF (RAW), Uncompressed, 14-bit <sup>3</sup>	—	25.4 MB	151	19
TIFF (RGB)	L	36.6 MB	105	16
	M	20.6 MB	187	19
	S	9.3 MB	416	27
JPEG fine <sup>4</sup>	L	6.0 MB	552	44
	M	3.4 MB	976	100
	S	1.5 MB	2100	100
JPEG normal <sup>4</sup>	L	3.0 MB	1000	100
	M	1.7 MB	1800	100
	S	0.8 MB	4100	100
JPEG basic <sup>4</sup>	L	1.5 MB	2100	100
	M	0.9 MB	3600	100
	S	0.4 MB	7800	100





- 1 All figures are approximate. File size varies with scene recorded.
- 2 Maximum number of exposures that can be stored in memory buffer at ISO 200. Drops if **Optimal quality** is selected for **JPEG compression**, ISO sensitivity is set to **Hi 3.3** or higher, **High ISO NR** is on when auto ISO sensitivity control is on or ISO sensitivity is set to 800 or higher, or long exposure noise reduction, active D-lighting, or image authentication is on.
- 3 Maximum frame rate when recording 14-bit NEF (RAW) images is 2.5 fps.
- 4 Figures assume **JPEG compression** is set to **Size priority**. Selecting **Optimal quality** increases the file size of JPEG images; number of images and buffer capacity drop accordingly.



#### **d6—Max. Continuous Release (📖 276)**

The maximum number of photographs that can be taken in a single burst can be set to any amount between 1 and 100.



# Battery Life

The number of shots that can be taken with fully-charged batteries varies with the condition of the battery, temperature, and how the camera is used. In the case of AA batteries, capacity also varies with make and storage conditions; some batteries can not be used. Sample figures for the camera and optional MB-D10 multi-power battery pack are given below.

- **CIPA standard**<sup>1</sup>

**One EN-EL3e battery (camera):** Approximately 950 shots

**One EN-EL3e battery (MB-D10):** Approximately 950 shots

**One EN-EL4a battery (MB-D10):** Approximately 2000 shots

**Two EN-EL3e batteries (MB-D10):** Approximately 1900 shots

**One EN-EL3e and one EN-EL4a battery (MB-D10):** Approximately 2950 shots

**Eight AA batteries (MB-D10):** Approximately 1200 shots

- **Nikon standard**<sup>2</sup>

**One EN-EL3e battery (camera):** Approximately 3000 shots

**One EN-EL3e battery (MB-D10):** Approximately 3000 shots

**One EN-EL4a battery (MB-D10):** Approximately 5900 shots

**Two EN-EL3e batteries (MB-D10):** Approximately 6000 shots

**One EN-EL3e and one EN-EL4a battery (MB-D10):** Approximately 8900 shots

**Eight AA batteries (MB-D10):** Approximately 3400 shots

1 Measured at 23 °C/73.4 °F (±2 °C/3.6 °F) with an AF-S VR 24–120mm f/3.5–5.6G ED lens under the following test conditions: lens cycled from infinity to minimum range and one photograph taken at default settings once every 30 s; flash fired once every other shot. Live view not used.

2 Measured at 20 °C/68 °F with an AF-S VR 70–200mm f/2.8G ED lens under the following test conditions: image quality set to JPEG basic, image size set to M (medium), shutter speed <sup>1</sup>/<sub>250</sub> s, shutter-release button pressed halfway for three seconds and focus cycled from infinity to minimum range three times; six shots are then taken in succession and monitor turned on for five seconds and then turned off; cycle repeated once exposure meters have turned off.



The following can reduce battery life:

- Using the monitor
- Keeping the shutter-release button pressed halfway
- Repeated autofocus operations
- Taking NEF (RAW) or TIFF (RGB) photographs
- Slow shutter speeds
- Using the optional WT-4 wireless transmitter
- Using the optional GP-1 GPS unit
- Using VR (vibration reduction) mode with VR lenses

To ensure that you get the most from rechargeable Nikon EN-EL3e batteries:

- Keep the battery contacts clean. Soiled contacts can reduce battery performance.
- Use batteries immediately after charging. Batteries will lose their charge if left unused.



# Index

## Symbols

---

- [+] (Single-point AF) ..... 76, 77
- [+] (Dynamic-area AF) ..... 76, 77, 264
- [+] (Auto-area AF) ..... 76, 77
- S ..... 74, 80, 86, 264
- CL ..... 86, 88, 276
- CH ..... 86, 88
- G ..... 86
- ☺ (Self-timer) ..... 86, 91
- MUP ..... 86, 93
- [+] (Matrix) ..... 102
- [+] (Center-weighted) ..... 102, 272
- [+] (Spot) ..... 102
- P (Programmed auto) ..... 106
- S (Shutter-priority auto) ..... 108
- A (Aperture-priority auto) ..... 109
- M (Manual) ..... 111
- ? (Help) ..... 18, 21
- ⌘ (Memory buffer) ..... 43, 89
- PRE (Preset manual) ..... 134, 142
- info (Info) button ..... 12, 15
- Live (Live view) button ..... 48, 58
- \*: switch ..... 39, 278

## Numerics

---

- 1,005-pixel RGB sensor ..... 170
- 12-bit ..... 70
- 14-bit ..... 70
- 3D color matrix metering II ..... 103
- 3D-tracking ..... 76, 77, 265
- 51 points (3D-tracking) ..... 265

## A

---

- A/V cable ..... i, 239
- AC adapter ..... 352
- Accessories ..... 352
- Active D-Lighting ..... 129, 164
- Active folder ..... 256
- Add items (My Menu) ..... 333
- ADL bracketing ..... 129, 289
- Adobe RGB ..... 166

## AE & flash

- (Auto bracketing set) ..... 120, 289
- AE only (Auto bracketing set) 120, 289
- AE-L** ..... 81, 116, 296
- AF ..... 74, 76, 78, 82
- AF activation ..... 266
- AF area brackets ..... 11, 36, 55
- AF assist ..... 43, 268, 345
- AF fine tune ..... 312
- AF point illumination ..... 266
- AF point selection ..... 267
- AF-area mode ..... 76
- AF-C priority selection ..... 263
- AF-ON** button ..... 75
- AF-On for MB-D10 ..... 269
- AF-S priority selection ..... 264
- After Delete ..... 251
- Amber ..... 138, 323
- Aperture ..... 109–112
- Aperture-priority auto ..... 109
- Approved memory cards ..... 393
- Aspect ratio ..... 321
- Assign AE-L/AF-L button ..... 296
- Assign Fn button ..... 292
- Assign preview button ..... 296
- Attaching the lens ..... 26
- Audio/video cable ..... i, 239
- Auto (White balance) ..... 134
- Auto bracketing ..... 120, 289, 290
- Auto bracketing (Mode M) ..... 290
- Auto bracketing set ..... 289
- Auto FP high-speed sync. .... 281, 282
- Auto image rotation ..... 304
- Auto meter off ..... 39, 273
- Auto meter-off delay ..... 273
- Auto-area AF ..... 76, 77
- Autofocus ..... 74, 76, 78, 82

## B

---

- Backlight ..... 39, 278
- Backup (Secondary slot function) ... 72

Battery ..... 22, 24, 37, 279, 280, 307  
Battery info ..... 307  
Battery order ..... 280  
Battery pack ..... 279, 280, 307, 352  
Beep ..... 275  
Black-and-white (Monochrome).... 322  
Body cap..... 5, 26, 355  
Border ..... 231, 235  
Bracketing..... 120, 289, 290  
Bracketing order ..... 290  
Built-in AF-assist illuminator ..... 268  
Bulb ..... 112, 114  
Burst ..... 186, 276, 293

---

**C**

---

**C** ..... 74, 81, 263, 264  
Camera Control Pro 2..... 224, 355  
Capture NX 2..... 69, 305, 355  
Center-weighted ..... 102, 272  
Center-weighted area..... 272  
Center-weighted metering..... 102, 272  
CF card slot ..... 31, 62, 72  
CF card slot  
(Primary slot selection)..... 72  
Charging the battery ..... 22  
Choose color temp.  
(White balance)..... 134, 141  
CL mode shooting speed..... 276  
Clean image sensor ..... 358  
Clock ..... 29, 302  
Clock battery..... 30  
Cloudy (White balance) ..... 134  
CLS ..... 348  
CLS-compatible flash units..... 348  
Color balance..... 323  
Color space ..... 166  
Color temperature ..... 134, 136, 141  
Commander mode ..... 285  
CompactFlash..... 31, 393  
CompactFlash card slot ..... 31  
Compatible lenses ..... 340  
Compressed (Type) ..... 70  
Computer ..... 224  
Connector for external  
microphone..... 4, 58

Continuous high speed ..... 86, 88  
Continuous low speed ..... 86, 88, 276  
Continuous release mode ..... 86, 88  
Continuous-servo AF... 74, 81, 263, 264  
Contrast-detect ..... 50  
Contrast-detect autofocus ... 48, 50, 51  
Control panel..... 8  
Copy image(s) ..... 248  
Copyright..... 214, 309  
Copyright information ..... 309  
CPU lens ..... 27, 340  
Creative Lighting System..... 347, 348  
Cropping  
(PictBridge [Setup] menu) ..... 231  
Custom setting bank ..... 262  
Custom Settings..... 260  
Customize command dials..... 297  
Cyanotype (Monochrome)..... 322

---

**D**

---

Date and time ..... 29, 302  
Date format..... 30, 302  
Daylight saving time..... 29, 302  
DCF version 2.0..... 167, 392  
Default settings ..... 182, 256, 262, 368  
Delete..... 46, 220  
Delete all images..... 221  
Delete current image ..... 46, 220  
Depth-of-field ..... 105  
Depth-of-field preview  
button ..... 105, 289, 296  
Digital Print Order  
Format..... 228, 233, 237, 392  
Diopter..... 36, 353  
Diopter adjustment control ..... 36  
Direct sunlight (White balance)..... 134  
Display mode ..... 247  
D-Lighting ..... 319  
DPOF ..... 228, 233, 237, 392  
Dust off ref photo ..... 305  
Dynamic AF area ..... 264  
Dynamic-area AF..... 76, 77, 264

---

**E**

---

Easy exposure compensation ..... 271

Electronic rangefinder .....	84, 340, 342
Ethernet .....	227, 352
EV steps for exposure cntrl. ....	270
Exif version 2.21 .....	167, 392
Exp comp/fine tune.....	270
Exposure.....	101, 102, 116, 118
Exposure bracketing .....	120, 289, 290
Exposure compensation .....	118
Exposure delay mode .....	278
Exposure indicator .....	113
Exposure lock.....	116
Exposure meters.....	39, 273
Exposure mode .....	104
Exposure program .....	372
External microphone .....	58, 62
Eye-Fi upload .....	313
<b>F</b>	
File information.....	208
File naming.....	258
File number sequence .....	277
Filter effects .....	322
Filter effects (Set Picture Control) .....	157, 158
Fine tune optimal exposure .....	272
Firmware version .....	314
Flash .....	171, 175, 177, 178
Flash (White balance) .....	134
Flash bracketing .....	120, 289, 290
Flash cntrl for built-in flash .....	283
Flash compensation .....	177
Flash control.....	170
Flash mode .....	175
Flash only (Auto bracketing set).....	120, 289
Flash range .....	174
Flash ready indicator.....	92, 171, 179
Flash shutter speed .....	282
Flash sync speed.....	108, 281, 282
Flash sync terminal .....	347
Flexible program .....	107
Fluorescent (White balance) .....	134
<b>Fn</b> button .....	121, 125, 129, 179, 292
f-number .....	109, 110, 341
Focal length.....	195, 344

Focal length scale .....	26
Focal plane mark .....	84
Focus .....	73, 74, 76, 78, 80, 83
Focus indicator .....	43, 84
Focus lock .....	80
Focus mode.....	74
Focus mode switch.....	27
Focus point.....	50, 76, 78, 264, 267
Focus point wrap-around .....	267
Focus tracking.....	75, 265, 266
Focus tracking with lock-on.....	266
Focusing screen.....	386
Format.....	34, 301
Format memory card.....	301
Frame interval (Slide show).....	252
Front-curtain sync .....	175
Full-frame playback.....	204
FV lock.....	178

## G

GPS .....	198, 214
GPS data .....	214
GPS unit.....	198

## H

Hand-held.....	52
HDMI.....	241, 302, 392
HDMI mini-pin connector .....	4
Help.....	18, 21
Hi.....	97
Hide image.....	245
High definition.....	241, 302, 392
High ISO NR.....	259
Highlights .....	209
Histogram .....	210, 211

## I

Image authentication.....	308
Image comment.....	303
Image Dust Off ref photo .....	305
Image file .....	392
Image overlay .....	324
Image quality .....	68
Image review .....	206, 251
Image size .....	71

Incandescent (White balance).....	134
Index print .....	236
In-focus indicator .....	43, 74
Information .....	207, 247
Information display .....	12, 278
Interval timer shooting .....	189
ISO sensitivity .....	95, 96, 98
ISO sensitivity auto control.....	98
ISO sensitivity settings .....	97
ISO sensitivity step value.....	270
i-TTL.....	170, 171, 285
i-TTL balanced-fill flash for digital SLR.....	170
<b>J</b>	
JPEG .....	68
JPEG basic .....	68
JPEG compression.....	70
JPEG fine.....	68
JPEG normal.....	68
<b>L</b>	
L .....	71
LAN.....	352
Language .....	28, 303
LCD .....	39, 278, 301
LCD brightness.....	301
LCD illumination.....	278
Lens.....	26, 27, 195, 312, 340
Lens cap.....	26
Lens distance information .....	170
Lens focus ring .....	26, 83
Lens mount .....	5, 27
Lens mounting index.....	26
Lens VR switch.....	26
Live view.....	48–56, 57–65
Live view mode.....	49, 52
Lo .....	97
Local area network .....	352
Lock mirror up for cleaning .....	361
Long exp. NR.....	258
Lossless compressed (Type).....	70
<b>M</b>	
M.....	53, 74, 83, 111
Magenta.....	138, 323
Manage Picture Control .....	160
Manual.....	53, 74, 83, 111
Manual (Exposure mode).....	111
Manual (Flash cntrl for built-in flash) .....	284
Manual focus.....	53, 74, 83
Matrix .....	102
Matrix metering.....	102
Max. continuous release .....	276
Maximum aperture .....	84, 195
Maximum sensitivity .....	98
MB-D10.....	269, 279, 280, 307, 352
MB-D10 battery type.....	279
Memory buffer.....	43, 86, 89, 90
Memory card.....	31, 301, 393
Memory card capacity .....	394
Metering .....	102
Metering selector.....	41, 103
Microphone .....	5, 58, 62
Minimum aperture.....	27, 104
Minimum shutter speed.....	99
Mired .....	139
Mirror .....	48, 93, 361
Mirror up .....	93
Mirror up mode .....	86, 93
Modeling flash .....	105, 289
Monitor.....	12, 45, 48, 204, 301
Monitor cover.....	16
Monitor off delay .....	274
Monitor pre-flash.....	170, 179
Monochrome.....	322
Monochrome (Set Picture Control).....	154
Mounting index.....	26
Movie settings.....	62
Movies.....	58
Multi selector.....	19, 292
Multi selector center button.....	291
Multiple exposure.....	184
My Menu .....	333
<b>N</b>	
NEF .....	68, 70
NEF (RAW).....	68, 70

NEF (RAW) bit depth .....	70
NEF (RAW) processing .....	327
NEF (RAW) recording .....	70
Neutral (Set Picture Control) .....	154
Nikon Transfer .....	224
No memory card? .....	299
No. of copies (PictBridge [Setup] menu) .....	230
Non-CPU lens .....	195, 342
Non-CPU lens data .....	195

## O

---

Optimal quality (JPEG compression) .....	70
Optional flash .....	283
Overflow (Secondary slot function) .....	72
Overview data .....	215

## P

---

Page size .....	230, 235
Phase-detection autofocus .....	48
Photo info .....	207, 247
Photo info/playback .....	292
PictBridge .....	228, 392
Picture angle .....	346
Picture Controls .....	154
Playback .....	45, 203
Playback folder .....	245
Playback information .....	207, 247
Playback menu .....	244
Playback slot and folder .....	217
Playback zoom .....	218
Predictive .....	75
Predictive focus tracking .....	74, 75
Preset manual (White balance) .....	134, 142
Press the shutter-release button all the way down .....	44
Press the shutter-release button halfway .....	43, 44, 80, 116
Primary slot selection .....	72
Print (DPOF) .....	233
Print options (PictBridge [Setup] menu) .....	230

Print select .....	233
Print set (DPOF) .....	237
Printing .....	228
Programmed auto .....	106
Protecting photographs .....	219

## Q

---

Quality (Movie settings) .....	62
--------------------------------	----

## R

---

Rank items (My Menu) .....	336
RAW primary, JPEG secondary (Secondary slot function) .....	72
Rear lens cap .....	26
Rear-curtain sync .....	175
Recent settings .....	337
Rechargeable Li-ion battery .... i, 22, 392	
Red-eye correction .....	320
Red-eye reduction .....	175
Release button to use dial .....	298
Release mode .....	85
Release mode dial .....	87
Release mode dial lock release .....	87
Remote cord .....	51, 93, 356
Remove items (My Menu) .....	335
Removing the lens from the camera .....	27
Repeating flash .....	284
Reset .....	182, 256, 262
Reset custom settings .....	262
Reset shooting menu .....	256
Resize .....	329
Restoring default settings .....	182, 256, 262, 368
Retouch menu .....	315
Reverse indicators .....	299
RGB .....	68, 166, 210
RGB Histogram .....	210
Rotate tall .....	251

## S

---

S .....	71
Save/load settings .....	310
Saving camera settings .....	310
Screen tips .....	276



SD card slot..... 32, 62, 72  
 SD card slot  
 (Primary slot selection)..... 72  
 SD memory card..... 32, 72, 393  
 Secondary slot function..... 72  
 Self-timer..... 86, 91, 273  
 Sensitivity..... 95, 96, 98  
 Sepia (Monochrome) ..... 322  
 Set Picture Control..... 154  
 Setup menu..... 300  
 Shade (White balance) ..... 134  
 Shooting data..... 212, 213, 214  
 Shooting info display..... 278  
 Shooting menu ..... 253  
 Shooting menu bank..... 254  
 Shutter-priority auto ..... 108  
 Shutter-release  
 button..... 43, 44, 80, 116, 273  
 Shutter-release button AE-L..... 273  
 Side-by-side comparison ..... 331  
 Single-frame ..... 86  
 Single-point AF..... 76, 77  
 Single-servo AF ..... 74, 80, 264  
 Size ..... 62, 71  
 Size priority (JPEG compression)..... 70  
 Skylight..... 322  
 Slide show..... 252  
 Slot ..... 31, 72, 217  
 Slow sync ..... 175  
 Speaker ..... 5, 7  
 Speedlights ..... 347  
 Spot..... 102  
 Spot metering ..... 102  
 sRGB..... 166  
 Standard (Set Picture Control)..... 154  
 Standard i-TTL flash for  
 digital SLR..... 170  
 Start printing ..... 232, 235

## **T**

Television ..... 239, 301, 302  
 Ten-pin remote terminal ..... 198, 356  
 Thumbnail ..... 216  
 Thumbnail playback ..... 216  
 TIFF (RGB)..... 68

Time ..... 29, 302  
 Time stamp ..... 231, 235  
 Time zone ..... 29, 302  
 Time zone and date ..... 29, 302  
 Timer ..... 91, 189  
 Toning (Set Picture Control)... 157, 159  
 Trim ..... 321  
 Tripod ..... 49  
 Two-button reset ..... 182

## **U**

Uncompressed (Type)..... 70  
 USB..... 224, 229  
 USB cable ..... i, 225, 229  
 UTC..... 29, 201, 214

## **V**

Video mode ..... 301  
 Viewfinder ..... 10, 36, 91, 191, 386  
 Viewfinder eyepiece ..... 91, 191  
 Viewfinder eyepiece cap..... i, 91, 191  
 Viewfinder focus ..... 36, 83  
 Viewfinder grid display..... 275  
 Viewfinder warning display ..... 275  
 ViewNX ..... 69, 167  
 Virtual horizon ..... 55, 311  
 Vivid (Set Picture Control)..... 154

## **W**

Warm filter ..... 322  
 WB ..... 125, 134  
 WB bracketing  
 (Auto bracketing set) ..... 125, 129, 289  
 White balance ..... 125, 134  
 White balance bracketing..... 125  
 Wireless ..... 227, 352  
 Wireless network..... 227, 352  
 Wireless transmitter..... 227, 352  
 WT-4..... 227, 352



---

---

---

---

---

---

---

---

---

---

---

---

---

---

---

---

---

---

---

---

---

---

---

---

---

---

---

---

---

---



# **Nikon**

No reproduction in any form of this manual, in whole or in part (except for brief quotation in critical articles or reviews), may be made without written authorization from NIKON CORPORATION.

**NIKON CORPORATION**

Fuji Bldg., 2-3 Marunouchi 3-chome,  
Chiyoda-ku, Tokyo 100-8331, Japan

© 2009 Nikon Corporation



Printed in Europe  
SB9G01(11)  
6MB05711-01