

**Nikon**

DIGITAL CAMERA

# COOLPIX P7000

## User's Manual

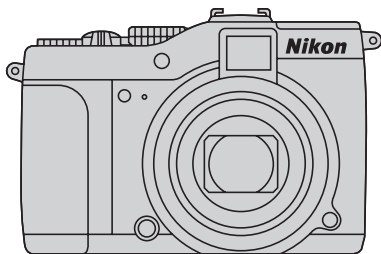

En

### **Trademark Information**

- Microsoft, Windows and Windows Vista are either registered trademarks or trademarks of Microsoft Corporation in the United States and/or other countries.
- Macintosh, Mac OS, and QuickTime are trademarks of Apple Inc.
- Adobe and Acrobat are registered trademarks of Adobe Systems Inc.
- SDXC, SDHC and SD Logos are trademarks of SD-3C, LLC.
- PictBridge is a trademark.
- HDMI, **HDMI** logo and High-Definition Multimedia Interface are trademarks or registered trademarks of HDMI Licensing LLC.
- ACCESS and NetFront are registered trademarks or trademarks of ACCESS Co., LTD in Japan, the United States and/or other countries. **NetFront™**
- All other trade names mentioned in this manual or the other documentation provided with your Nikon product are trademarks or registered trademarks of their respective holders.

### **AVC Patent Portfolio License**

This product is licensed under the AVC Patent Portfolio License for the personal and non-commercial use of a consumer to (i) encode video in compliance with the AVC standard ("AVC video") and/or (ii) decode AVC video that was encoded by a consumer engaged in a personal and non-commercial activity and/or was obtained from a video provider licensed to provide AVC video. No license is granted or shall be implied for any other use. Additional information may be obtained from MPEG LA, L.L.C.

See <http://www.mpegla.com>.

<b>Introduction</b>	
<b>First Steps</b>	
<b>Basic Photography and Playback: 📷 (Auto) Mode</b>	
<b>More on Shooting</b>	
<b>More on Playback</b>	
<b>Editing Pictures</b>	
<b>Movie Recording and Playback</b>	
<b>Connecting to Televisions, Computers and Printers</b>	
<b>Basic Camera Setup</b>	
<b>Caring for the Camera</b>	
<b>Technical Notes and Index</b>	

## For Your Safety

To prevent damage to your Nikon product or injury to yourself or to others, read the following safety precautions in their entirety before using this equipment. Keep these safety instructions where all those who use the product will read them. The consequences that could result from failure to observe the precautions listed in this section are indicated by the following symbol:



This icon marks warnings, information that should be read before using this Nikon product, to prevent possible injury.

### WARNINGS

#### **Turn off in the event of malfunction**

Should you notice smoke or an unusual smell coming from the camera or Battery Charger, unplug the Battery Charger and remove the battery immediately, taking care to avoid burns. Continued operation could result in injury. After removing or disconnecting the power source, take the equipment to a Nikon-authorized service representative for inspection.

#### **Do not disassemble**

Touching the internal parts of the camera or Battery Charger could result in injury. Repairs should be performed only by qualified technicians. Should the camera or Battery Charger break open as the result of a fall or other accident, take the product to a Nikon-authorized service representative for inspection, after unplugging the product and/or removing the battery.

#### **Do not use the camera or Battery Charger in the presence of flammable gas**

Do not use electronic equipment in the presence of flammable gas, as this could result in explosion or fire.

#### **Do not look at the sun through the viewfinder**

Viewing the sun or other strong light source through the viewfinder could cause permanent visual impairment.

#### **Handle the camera strap with care**

Never place the strap around the neck of an infant or child.

#### **Keep out of reach of children**

Particular care should be taken to prevent infants from putting the battery or other small parts into their mouths.

** Observe caution when handling the battery**

The battery may leak or explode if improperly handled. Observe the following precautions when handling the battery for use in this product:

- Before replacing the battery, turn the product off. If you are using an AC adapter, be sure it is unplugged.
  - Use only a Rechargeable Li-ion Battery EN-EL14 (supplied). Charge the battery by inserting it in a Battery Charger MH-24 (supplied).
  - When inserting the battery, do not attempt to insert it upside down or backwards.
  - Do not short or disassemble the battery or attempt to remove or break the battery insulation or casing.
  - Do not expose the battery to flame or to excessive heat.
  - Do not immerse in or expose to water.
  - Replace the terminal cover when transporting the battery. Do not transport or store with metal objects such as necklaces or hairpins.
  - The battery is prone to leakage when fully discharged. To avoid damage to the product, be sure to remove the battery when no charge remains.
  - Discontinue use immediately should you notice any change in the battery, such as discoloration or deformation.
- If liquid from the damaged battery comes in contact with clothing or skin, rinse immediately with plenty of water.

** Observe the following precautions when handling the Battery Charger**

- Keep dry. Failure to observe this precaution could result in fire or electric shock.
- Dust on or near the metal parts of the plug should be removed with a dry cloth. Continued use could result in fire.
- Do not handle the plug or go near the Battery Charger during lightning storms. Failure to observe this precaution could result in electric shock.
- Do not damage, modify or forcibly tug, place it under heavy objects, or expose it to heat or flames. Should the insulation be damaged and the wires become exposed, take it to a Nikon-authorized service representative for inspection. Failure to observe these precautions could result in fire or electric shock.
- Do not handle the plug or Battery Charger with wet hands. Failure to observe this precaution could result in electric shock.
- Do not use with travel converters or adapters designed to convert from one voltage to another or with DC-to-AC inverters. Failure to observe this precaution could damage the product or cause overheating or fire.

 **Use appropriate cables**

When connecting cables to the input and output jacks, use only the cables provided or sold by Nikon for the purpose, to maintain compliance with product regulations.

 **Handle moving parts with care**

Be careful that your fingers or other objects are not pinched by the lens cover or other moving parts.

 **CD-ROMs**

The CD-ROMs supplied with this device should not be played back on audio CD equipment. Playing CD-ROMs on an audio CD player could cause hearing loss or damage the equipment.

 **Observe caution when using the flash**

Using the flash close to your subject's eyes could cause temporary visual impairment. Particular care should be observed if photographing infants, when the flash should be no less than 1 m (3 ft. 4 in.) from the subject.

 **Do not operate the flash with the flash window touching a person or object**

Failure to observe this precaution could result in burns or fire.

 **Avoid contact with liquid crystal**

Should the monitor break, care should be taken to avoid injury caused by broken glass and to prevent liquid crystal from the monitor touching the skin or entering the eyes or mouth.

 **Turn the power off when using inside an airplane or the hospital**

Turn the power off while inside the airplane during take off or landing. Follow the instructions of the hospital when using while in a hospital. The electromagnetic waves given out by this camera may disrupt the electronic systems of the airplane or the instruments of the hospital.

# Notices

## **Notices for Customers in the U.S.A.**

### **IMPORTANT SAFETY INSTRUCTIONS- SAVE THESE INSTRUCTIONS.**

#### **DANGER – TO REDUCE THE RISK OF FIRE OR ELECTRIC SHOCK, CAREFULLY FOLLOW THESE INSTRUCTIONS**

For connection to a supply not in the U.S.A., use an attachment plug adapter of the proper configuration for the power outlet if needed.

The power supply unit is intended to be correctly orientated in a vertical or floor mount position.

#### **Federal Communications Commission (FCC) Radio Frequency Interference Statement**

This equipment has been tested and found to comply with the limits for a Class B digital device, pursuant to Part 15 of the FCC rules. These limits are designed to provide reasonable protection against harmful interference in a residential installation. This equipment generates, uses, and can radiate radio frequency energy and, if not installed and used in accordance with the instructions, may cause harmful interference to radio communications. However, there is no guarantee that interference will not occur in a particular installation. If this equipment does cause harmful

interference to radio or television reception, which can be determined by turning the equipment off and on, the user is encouraged to try to correct the interference by one or more of the following measures:

- Reorient or relocate the receiving antenna.
- Increase the separation between the equipment and receiver.
- Connect the equipment into an outlet on a circuit different from that to which the receiver is connected.
- Consult the dealer or an experienced radio/television technician for help.



*Nikon*

COOLPIX P7000

### **CAUTIONS**

#### **Modifications**

The FCC requires the user to be notified that any changes or modifications made to this device that are not expressly approved by Nikon Corporation may void the user's authority to operate the equipment.

#### **Interface Cables**

Use the interface cables sold or provided by Nikon for your equipment. Using other interface cables may exceed the limits of Class B Part 15 of the FCC rules.

## **Notice for Customers in the State of California**

### **WARNING**

Handling the cord on this product will expose you to lead, a chemical known to the State of California to cause birth defects or other reproductive harm.

### ***Wash hands after handling.***

Nikon Inc.,  
1300 Walt Whitman Road,  
Melville, New York 11747-3064  
USA  
Tel: 631-547-4200

## **Notice for Customers in Canada**

### **CAUTION**

This Class B digital apparatus complies with Canadian ICES-003.

### **ATTENTION**

Cet appareil numérique de la classe B est conforme à la norme NMB-003 du Canada.

## **Notices for Customers in Europe**

### **CAUTION**

**RISK OF EXPLOSION IF BATTERY IS REPLACED BY AN INCORRECT TYPE. DISPOSE OF USED BATTERIES ACCORDING TO THE INSTRUCTIONS.**

This symbol indicates that this product is to be collected separately.

The following apply only to users in European countries:



- This product is designated for separate collection at an appropriate collection point. Do not dispose of as household waste.
- For more information, contact the retailer or the local authorities in charge of waste management.

This symbol on the battery indicates that the battery is to be collected separately.



The following apply only to users in European countries:



- All batteries, whether marked with this symbol or not, are designated for separate collection at an appropriate collection point. Do not dispose of as household waste.
- For more information, contact the retailer or the local authorities in charge of waste management.









# Table of Contents









For Your Safety .....	ii
WARNINGS .....	ii
Notices .....	v
<hr/>	
Introduction .....	1
About This Manual .....	1
Information and Precautions .....	2
Parts of the Camera .....	4
Camera Body .....	4
Monitor .....	6
Basic Operations.....	9
Command Dial .....	9
Av (Av/Tv) Button .....	9
Quick Menu Dial and Quick Menu Button .....	10
Pressing the Shutter-Release Button Halfway/All the Way Down.....	10
AE-L/AF-L (AE-L/AF-L) Button.....	11
Fn (FUNC) Button .....	11
Rotary Multi Selector .....	12
MENU Button .....	13
Switching Between Tabs in the Menu Screen .....	14
L (Monitor) Button .....	14
Attaching the Camera Strap .....	15
<hr/>	
First Steps .....	16
Charging the Battery .....	16
Inserting the Battery .....	18
Removing the Battery .....	19
Turning On and Off the Camera .....	19
Setting the Display Language, Date and Time .....	20
Inserting the Memory Card .....	22
Removing the Memory Card .....	22

## Table of Contents

Basic Photography and Playback:  (Auto) Mode.....	24
Step 1 Turn the Camera On and Select  (Auto) Mode.....	24
Indicators Displayed in  (Auto) Mode .....	25
Step 2 Frame a Picture.....	26
Using the Viewfinder .....	26
Using the Zoom.....	27
Step 3 Focus and Shoot .....	28
Step 4 Viewing and Deleting Pictures .....	30
Viewing Pictures (Playback Mode) .....	30
Deleting Unnecessary Pictures .....	31
Using the Flash.....	32
Setting the Flash Mode.....	33
Taking Pictures with the Self-Timer .....	35
Taking Pictures of Smiling Faces (Smile Timer) .....	36
Shooting with Remote Control .....	38
Using Focus Mode .....	40
Setting the Focus Mode.....	41
Using Manual Focus.....	42
Adjusting the Brightness (Exposure Compensation).....	43
More on Shooting .....	44
Selecting a Shooting Mode (Mode Dial).....	44
Selecting Scenes for Shooting (Scene Mode).....	45
Setting the Scene Mode.....	45
Shooting in the Scene Selected by the Camera (Scene Auto Selector).....	46
Selecting a Scene Mode to Take Pictures (Features) .....	48
Taking Pictures for a Panorama .....	56
Shooting Low-lit Scenes (Low Noise Night Mode) .....	58
Low Noise Night Menu .....	59
Setting the Exposure for Shooting (P, S, A, M Modes) .....	60
P, S, A, M Modes .....	60
P (Programmed Auto) Mode.....	62
S (Shutter-Priority Auto) Mode .....	63
A (Aperture-Priority Auto) Mode.....	64
M (Manual) Mode.....	65
Changing the Frequently Used Settings for Shooting (P, S, A, M Modes) .....	67
Quick Menu .....	67
QUAL Choosing the Image Quality and the Image Size.....	68
ISO Setting the ISO Sensitivity.....	74
WB Matching Image Colors with Colors as Seen with the Naked Eye (White Balance).....	76
BKT Continuous Shooting while Changing the Shutter Speed, ISO Sensitivity and White Balance (Bracketing).....	80

Checking the Picture Brightness Distribution (P, S, A, M Modes).....	82
Selecting the Focus Area (P, S, A, M Modes).....	84
Focusing on Moving Subjects for Shooting (Subject Tracking).....	88
<b>Shooting Options: Shooting Menu (P, S, A, M Modes).....</b>	<b>90</b>
Picture Control (COOLPIX Picture Control).....	92
Custom Picture Control (COOLPIX Custom Picture Control).....	96
Metering.....	98
Continuous.....	99
Autofocus Mode.....	102
Flash Exp. Comp.....	102
Noise Reduction Filter.....	103
Long Exposure NR.....	103
Distortion Control.....	104
Wide-angle Converter.....	104
Flash Control.....	105
Active D-Lighting.....	106
Zoom Memory.....	107
Functions that Cannot be Applied Simultaneously.....	108
<b>U1, U2 and U3 (User Setting Modes).....</b>	<b>112</b>
Save the Settings in U1, U2 or U3.....	113
Shooting in U1, U2 or U3 (User Setting) Mode.....	114
Resetting Saved Settings.....	114
<b>More on Playback.....</b>	<b>115</b>
Operations in Full-Frame Playback.....	115
Viewing Multiple Pictures: Thumbnail Playback.....	116
Calendar Display.....	117
Taking a Closer Look: Playback Zoom.....	118
Viewing Pictures by Date (List by Date).....	119
Selecting a Date in List by Date Mode.....	119
Operations in List by Date Mode.....	120
List by Date Menus.....	121
<b>Playback Options: Playback Menu.....</b>	<b>122</b>
 Print Set: Setting the Pictures and Number of Copies to Print.....	123
 Slide Show.....	126
 Delete: Deleting Multiple Pictures.....	127
Selecting Pictures.....	128
 Protect.....	129
 Rotate Image.....	130
 Hide Image.....	130
 Copy: Copying Between the Internal Memory and Memory Card.....	131
<b>Voice Memos: Recording and Playback.....</b>	<b>132</b>
Recording Voice Memos.....	132
Playing Voice Memos.....	132
Deleting Voice Memos.....	132

## Table of Contents

<b>Editing Pictures .....</b>	<b>133</b>
<b>Picture Editing Functions .....</b>	<b>133</b>
<b>Editing Pictures .....</b>	<b>135</b>
 Quick Retouch: Enhancing Contrast and Saturation .....	135
 D-Lighting: Enhancing Brightness and Contrast .....	136
 Small Picture: Resizing Pictures .....	137
 Black Border: Adding a Black Border to Pictures .....	138
 Skin Softening: Making Skin Appear Smoother .....	139
 Straighten: Compensating for Picture Slanting .....	141
 Miniature Effect: Setting Close-up Miniature Effects .....	142
<b>NRW</b> NRW (RAW) Processing: Creating JPEG Images from NRW Images .....	143
 Crop: Cropping Pictures .....	145
<b>Movie Recording and Playback .....</b>	<b>146</b>
<b>Recording Movies .....</b>	<b>146</b>
Selecting a Movie Type to Shoot .....	148
Changing the Movie Mode Settings .....	149
Autofocus Mode .....	150
Wind Noise Reduction .....	150
<b>Movie Playback .....</b>	<b>151</b>
Editing Movies .....	152
Saving a Frame from a Movie as a Still Picture .....	153
Deleting Unnecessary Movies .....	153
<b>Connecting to Televisions, Computers and Printers .....</b>	<b>154</b>
<b>Connecting to a TV .....</b>	<b>154</b>
<b>Connecting to a Computer .....</b>	<b>156</b>
Before Connecting the Camera .....	156
Transferring Images from a Camera to a Computer .....	157
<b>Connecting to a Printer .....</b>	<b>161</b>
Connecting the Camera and Printer .....	162
Printing Pictures One at a Time .....	163
Printing Multiple Pictures .....	164

---

<b>Basic Camera Setup .....</b>	<b>167</b>
<b>Setup Menu.....</b>	<b>167</b>
Welcome Screen .....	169
Date .....	170
Monitor Settings.....	173
Date Imprint.....	174
Vibration Reduction .....	175
Motion Detection .....	176
AF Assist.....	177
Red-eye Reduction .....	177
Digital Zoom.....	178
Zoom Speed .....	179
Sound Settings.....	179
Record Orientation .....	180
Auto Off .....	181
Format Memory/Format Card.....	182
Language.....	183
TV Settings.....	183
Built-in ND Filter.....	184
AE/AF Lock Button .....	185
Fn Button .....	186
Av/Tv Button.....	187
Customize My Menu.....	187
Reset File Numbering.....	188
Blink Warning .....	189
Reset All .....	191
Firmware Version.....	194
<b>Caring for the Camera.....</b>	<b>195</b>
<b>Caring for the Camera .....</b>	<b>195</b>
Cleaning .....	197
Storage.....	198

---

## Table of Contents

---

<b>Technical Notes and Index .....</b>	<b>199</b>
<b>Optional Accessories .....</b>	<b>199</b>
Using Speedlights (External Flash Unit).....	202
<b>File and Folder Names .....</b>	<b>203</b>
<b>Error Messages .....</b>	<b>205</b>
<b>Troubleshooting .....</b>	<b>210</b>
<b>Specifications .....</b>	<b>217</b>
Supported Standards .....	220
Approved Memory Cards .....	221
<b>Index .....</b>	<b>222</b>

## About This Manual

Thank you for your purchase of Nikon COOLPIX P7000 digital camera. This manual is written to help you enjoy taking pictures with your Nikon digital camera. Read this manual thoroughly before use, and keep it where all those who use the product will read it.

### Symbols and Conventions

To make it easier to find the information you need, the following symbols and conventions are used:



This icon marks cautions, information that should be read before use, to prevent damage to the camera.



This icon marks tips, additional information that may be helpful when using the camera.



This icon marks notes, information that should be read before using the camera.



This icon indicates that more information is available elsewhere in this manual or in the *Quick Start Guide*.

### Notations

- Secure Digital (SD) memory card, SDHC memory card, and SDXC memory card are referred to as “memory card.”
- The setting at the time of purchase is referred to as the “default setting”.
- The names of menu items displayed in the camera monitor, and the names of buttons or messages displayed in a computer monitor are indicated in bold text.

### Screen Samples

In this manual, images are sometimes omitted from monitor display samples so that monitor indicators can be more clearly shown.

### Illustrations and Screen Display

Illustrations and text displays shown in this manual may differ from actual display.

### Memory Cards

Pictures taken with this camera can be stored in the camera's internal memory or on removable memory cards. If a memory card is inserted, the memory card is used. To use the internal memory for shooting, playback, deleting or formatting, remove the memory card.

# Information and Precautions

## Life-Long Learning

As part of Nikon's "Life-Long Learning" commitment to ongoing product support and education, continually updated information is available online at the following sites:

- For users in the U.S.A.: <http://www.nikonusa.com/>
- For users in Europe and Africa: <http://www.europe-nikon.com/support/>
- For users in Asia, Oceania, and the Middle East: <http://www.nikon-asia.com/>

Visit these sites to keep up-to-date with the latest product information, tips, answers to frequently asked questions (FAQs), and general advice on digital imaging and photography. Additional information may be available from the Nikon representative in your area. See the URL below for contact information:

<http://imaging.nikon.com/>

## Use Only Nikon Brand Electronic Accessories

Nikon COOLPIX cameras are designed to the highest standards and include complex electronic circuitry. Only Nikon brand electronic accessories (including battery chargers, batteries and AC adapters) certified by Nikon specifically for use with this Nikon digital camera are engineered and proven to operate within the operational and safety requirements of this electronic circuitry.

**THE USE OF NON-NIKON ELECTRONIC ACCESSORIES COULD DAMAGE THE CAMERA AND MAY VOID YOUR NIKON WARRANTY.**

The use of third-party rechargeable Li-ion batteries not bearing the Nikon holographic seal could interfere with normal operation of the camera or result in the batteries overheating, igniting, rupturing, or leaking.

For more information about Nikon brand accessories, contact a local authorized Nikon dealer.

**Holographic seal:** Identifies this device as an authentic Nikon product.



## Before Taking Important Pictures

Before taking pictures on important occasions (such as at weddings or before taking the camera on a trip), take a test shot to ensure that the camera is functioning normally. Nikon will not be held liable for damages or lost profits that may result from product malfunction.

## About the Manuals

- No part of the manuals included with this product may be reproduced, transmitted, transcribed, stored in a retrieval system, or translated into any language in any form, by any means, without Nikon's prior written permission.
- Nikon reserves the right to change the specifications of the hardware and software described in these manuals at any time and without prior notice.
- Nikon will not be held liable for any damages resulting from the use of this product.
- While every effort was made to ensure that the information in these manuals is accurate and complete, we would appreciate it were you to bring any errors or omissions to the attention of the Nikon representative in your area (address provided separately).



## Notice Concerning Prohibition of Copying or Reproduction

Note that simply being in possession of material that was digitally copied or reproduced by means of a scanner, digital camera or other device may be punishable by law.

### • Items prohibited by law from being copied or reproduced

Do not copy or reproduce paper money, coins, securities, government bonds or local government bonds, even if such copies or reproductions are stamped "Sample". The copying or reproduction of paper money, coins, or securities which are circulated in a foreign country is prohibited. Unless the prior permission of the government was obtained, the copying or reproduction of unused postage stamps or post cards issued by the government is prohibited.

The copying or reproduction of stamps issued by the government and of certified documents stipulated by law is prohibited.

### • Cautions on certain copies and reproductions

The government has issued cautions on copies or reproductions of securities issued by private companies (shares, bills, checks, gift certificates, etc.), commuter passes or coupon tickets, except when a minimum of necessary copies are to be provided for business use by a company. Also, do not copy or reproduce passports issued by the government, licenses issued by public agencies and private groups, ID cards and tickets, such as passes and meal coupons.

### • Comply with copyright notices

The copying or reproduction of copyrighted creative works such as books, music, paintings, woodcut prints, maps, drawings, movies and photographs is governed by national and international copyright laws. Do not use this product for the purpose of making illegal copies or to infringe copyright laws.

## Disposing of Data Storage Devices

Please note that deleting images or formatting data storage devices such as memory cards or built-in camera memory does not completely erase the original image data. Deleted files can sometimes be recovered from discarded storage devices using commercially available software, potentially resulting in the malicious use of personal image data. Ensuring the privacy of such data is the user's responsibility.

Before discarding a data storage device or transferring ownership to another person, erase all data using commercial deletion software, or format the device and then completely refill it with images containing no private information (for example, pictures of empty sky). Be sure to also replace any pictures selected for the welcome screen (□ 169). Care should be taken to avoid injury or damage to property when physically destroying data storage devices.

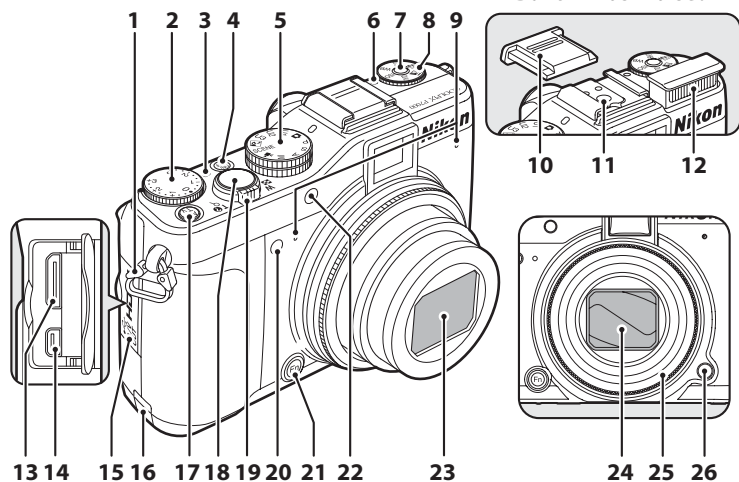

# Parts of the Camera

## Camera Body



**Built-in flash raised**

<b>1</b>	Eyelet for camera strap .....	15
<b>2</b>	Exposure compensation dial.....	43
<b>3</b>	Exposure compensation dial mark...	43
<b>4</b>	Power switch/power-on lamp... 19, 181	
<b>5</b>	Mode dial.....	44
<b>6</b>	Quick menu dial mark.....	67
<b>7</b>	Quick menu button .....	67
<b>8</b>	Quick menu dial.....	67
<b>9</b>	Microphone (stereo).....	132, 146
<b>10</b>	Accessory Shoe Cover BS-1 .....	202
<b>11</b>	Accessory shoe.....	202
<b>12</b>	Built-in flash .....	32
<b>13</b>	HDMI Mini Connector .....	154
<b>14</b>	USB/Audio video connector .....	154, 157, 162
<b>15</b>	Connector cover .....	154, 157, 162

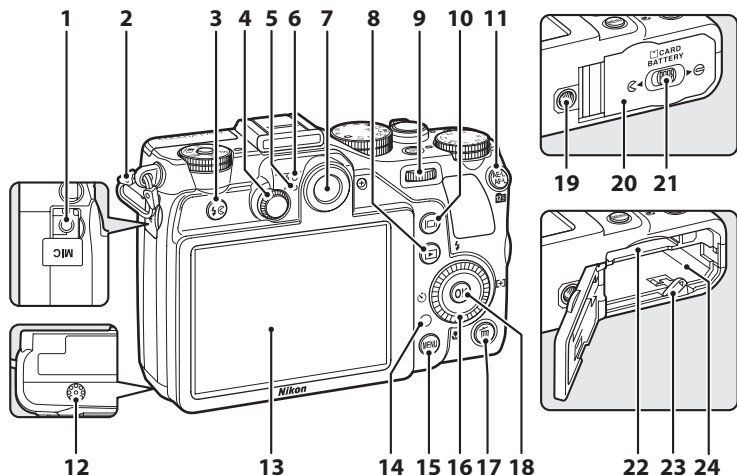

<b>16</b>	Power connector cover (for connection with an optional AC Adapter).....	199
<b>17</b>	$\frac{A}{TV}$ (Av/Tv) button.....	9, 187
<b>18</b>	Shutter-release button.....	10, 28
<b>19</b>	Zoom control.....	27
	<b>W</b> : Wide .....	27
	<b>T</b> : Tele.....	27
	 : Thumbnail playback.....	116
	 : Playback zoom.....	118
	 : Help .....	45
<b>20</b>	Infrared receiver (front).....	39
<b>21</b>	<b>Fn</b> (FUNC) button.....	11, 186
<b>22</b>	Self-timer lamp.....	35
<b>22</b>	AF-assist illuminator.....	177
<b>23</b>	Lens.....	197, 217
<b>24</b>	Lens cover	
<b>25</b>	Lens ring.....	105
<b>26</b>	Lens ring release button .....	105

## Bottom of camera



<b>1</b>	External microphone connector ..... 146	<b>13</b>	Monitor ..... 6, 14, 25
<b>2</b>	Eyelet for camera strap ..... 15	<b>14</b>	Infrared receiver (rear) ..... 39
<b>3</b>	(Flash pop-up) button ..... 33	<b>15</b>	<b>MENU</b> button ..... 13, 45, 91, 123, 149, 168
<b>4</b>	Diopter adjustment control ..... 26	<b>16</b>	Rotary multi selector ..... 12
<b>5</b>	Autofocus (AF) lamp ..... 28	<b>17</b>	(delete) button ..... 31, 132, 153
<b>6</b>	Flash lamp ..... 34	<b>18</b>	(apply selection) button ..... 12
<b>7</b>	Viewfinder ..... 26	<b>19</b>	Tripod socket
<b>8</b>	(playback) button ..... 30	<b>20</b>	Battery-chamber/ memory card slot cover ..... 18, 22
<b>9</b>	Command dial ..... 9	<b>21</b>	Cover latch ..... 18, 22
<b>10</b>	(monitor) button ..... 14, 15	<b>22</b>	Memory card slot ..... 22
<b>11</b>	(AE-L/AF-L) button ..... 11, 185	<b>23</b>	Battery latch ..... 18, 19
	(list by date) button ..... 119	<b>24</b>	Battery chamber ..... 18
<b>12</b>	Speaker ..... 132, 151		

## Monitor

Press the  (monitor) button to switch between displaying and hiding information ( 14). The displayed information varies according to the camera settings and condition.

## Shooting

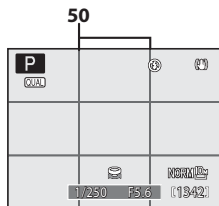
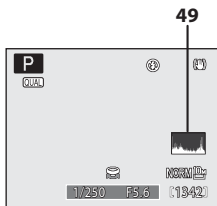
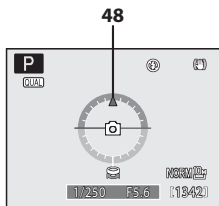
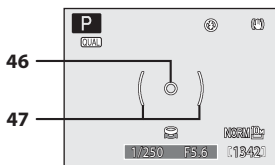
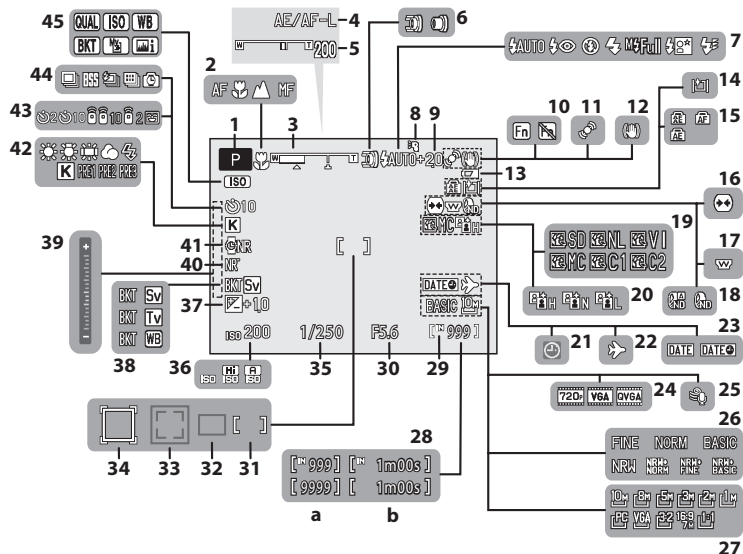

<b>1</b>	Shooting mode <sup>1</sup> .....24, 44, 45, 58, 60, 112, 146	<b>28</b>	(a) Number of exposures remaining (still pictures).....24, 71
<b>2</b>	Focus mode.....40	<b>29</b>	(b) Movie length .....146, 149
<b>3</b>	Zoom indicator .....27	<b>29</b>	Internal memory indicator..... 25
<b>4</b>	AE/AF-L indicator.....57	<b>30</b>	Aperture value ..... 61
<b>5</b>	Zoom memory .....11, 107	<b>31</b>	Focus area (for manual, center)....28, 84
<b>6</b>	Zoom speed setting.....179	<b>32</b>	Focus area (for auto)..... 84
<b>7</b>	Flash mode .....32	<b>33</b>	Focus area (for face detection)....36, 84
<b>8</b>	Speedlight.....202	<b>34</b>	Focus area (for subject tracking)..... 88
<b>9</b>	Flash exposure compensation .....102	<b>35</b>	Shutter speed..... 61
<b>10</b>	<b>Fn</b> button operation indicator .....11, 186	<b>36</b>	ISO sensitivity .....34, 74
<b>11</b>	Motion detection icon .....176	<b>37</b>	Exposure compensation value..... 43
<b>12</b>	Vibration reduction icon .....175	<b>38</b>	Bracketing..... 80
<b>13</b>	Battery level indicator .....24	<b>39</b>	Exposure indicator ..... 65
<b>14</b>	Monitor brightness boost indicator .....15	<b>40</b>	Noise reduction filter .....103
<b>15</b>	AE-L/AF-L button setting.....185	<b>41</b>	Long exposure noise reduction.....103
<b>16</b>	Distortion control.....104	<b>42</b>	White balance mode ..... 76
<b>17</b>	Wide-angle converter .....104	<b>43</b>	Self-timer indicator ..... 35
<b>18</b>	Built-in ND filter setting .....184	<b>43</b>	Remote Control.....38
<b>19</b>	COOLPIX Picture Control.....92	<b>44</b>	Smile timer .....36
<b>20</b>	Active D-Lighting.....106	<b>44</b>	Continuous shooting mode..... 99
<b>21</b>	"Date not set" indicator.....205	<b>45</b>	Quick menu dial indicator ..... 67
<b>22</b>	Travel destination indicator .....170	<b>46</b>	Spot metering area ..... 98
<b>23</b>	Date imprint.....174	<b>47</b>	Center-weighted area .....98
<b>24</b>	Movie options.....148	<b>48</b>	Virtual horizon <sup>2</sup> .....173
<b>25</b>	Wind noise reduction.....150	<b>49</b>	View/show histograms <sup>2</sup> .....173
<b>26</b>	Image quality .....68	<b>50</b>	View/show framing grid <sup>2</sup> .....173
<b>27</b>	Image size.....70		

1 The icons vary with the shooting mode.

2 The view or hide setting for the virtual horizon, histogram and framing grid displays can be changed in **Photo info** (☐173) of **Monitor settings** in the setup menu.

In shooting modes **U1**, **U2** and **U3**, set in **Photo info** of the specialized menus for **U1**, **U2** and **U3** (☐112).

## Playback

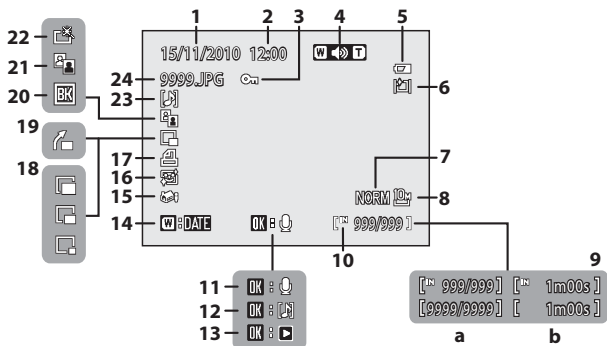

<b>1</b>	Date of recording.....	20	<b>12</b>	Voice memo playback guide.....	132
<b>2</b>	Time of recording.....	20	<b>13</b>	Movie playback guide.....	151
<b>3</b>	Protect icon.....	129	<b>14</b>	List by date guide.....	119
<b>4</b>	Volume indicator.....	132, 151	<b>15</b>	Miniature effect indicator.....	142
<b>5</b>	Battery level indicator.....	24	<b>16</b>	Skin softening icon.....	139
<b>6</b>	Monitor brightness boost indicator.....	15	<b>17</b>	Print-order icon.....	123
<b>7</b>	Image quality*.....	68	<b>18</b>	Small picture.....	137, 145
<b>8</b>	Image size*.....	70, 153	<b>19</b>	Straighten indicator.....	141
<b>8</b>	Movie options*.....	148	<b>20</b>	Black border indicator.....	138
<b>9</b>	(a) Current frame number/ total number of frames.....	30	<b>21</b>	D-Lighting icon.....	136
<b>9</b>	(b) Movie length.....	151	<b>22</b>	Quick retouch icon.....	135
<b>10</b>	Internal memory indicator.....	30	<b>23</b>	Voice memo indicator.....	132
<b>11</b>	Voice memo recording guide.....	132	<b>24</b>	File number and type.....	203

\* The icons vary with the settings used for shooting.

# Basic Operations

## Command Dial

You can rotate the command dial to select items from a menu screen or to set any of the following functions.

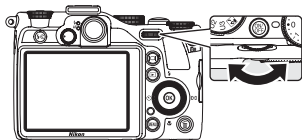

## For Shooting

Mode	Description	
Programmed auto (mode dial set to <b>P</b> )	Adjust the flexible program	62
Shutter-priority auto (mode dial set to <b>S</b> )	Adjust shutter speed	63
Aperture-priority auto (mode dial set to <b>A</b> )	Adjust aperture value (when the Av/Tv button is pressed*)	64
Manual (mode dial set to <b>M</b> )	Adjust shutter speed or aperture value (Press the Av/Tv button to switch between setting the shutter speed and aperture value.*)	65

\* When the **Av/Tv button** (187) setting is **Toggle Av/Tv selection** (default setting).

## For Playback

Mode	Description	
Full-frame playback or thumbnail playback	Choose a picture	30, 115, 116
Calendar display	Choose a date	117
Playback zoom	Change the zoom ratio	118
During movie pause or editing	Advanced or rewound by one frame	151

## Av/Tv (**Av/Tv**) Button

Press the Av/Tv button in shooting mode **S**, **A** or **M** to select whether to use the command dial or the rotary multi selector to set the shutter speed or aperture value.

- The Av/Tv button function can be changed with **Av/Tv button** (187) in the setup menu.

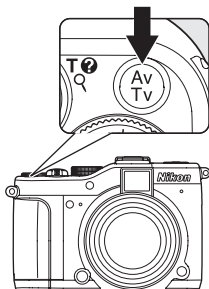

## Quick Menu Dial and Quick Menu Button

Rotate the quick menu dial to align the mark with the function that you want to set. Items such as **QUAL** (image quality and image size) can be set.

- When the quick menu button is pressed while shooting, the setting menu (quick menu) is displayed for the function that is selected with the mark.
- When  is chosen, the “Tone level information” (82) function is turned on with the quick menu button.
- Press the quick menu button again to exit the quick menu.
- Available functions differ according to the shooting mode.
- See “Quick Menu” (67) for more information.

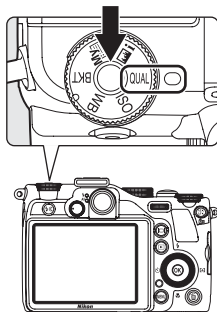

## Pressing the Shutter-Release Button Halfway/All the Way Down

The camera features a two-stage shutter-release button. To set the focus and exposure, press the shutter-release button halfway, stopping when you feel resistance. The focus and exposure lock while the shutter-release button is held in this position. To release the shutter and take a picture, press the shutter-release button the rest of the way down. Do not use force when pressing the shutter-release button, as this may result in camera shake and blurred pictures. Press the button slowly.



Press the shutter-release button halfway to lock the focus and exposure.

Press the shutter-release button the rest of the way down to shoot.



## AE-L/AF-L (AE-L/AF-L) Button

When shooting still pictures, instead of pressing the shutter-release button halfway, you can use the AE-L/AF-L button to shoot with focus lock (📖29).

- The exposure and focus are locked while the AE-L/AF-L button is pressed. Fully press the shutter-release button to release the shutter with the locked exposure and focus (default setting).
- The operations performed when the AE-L/AF-L button is pressed can be set with **AE/AF lock button** in the setup menu (📖185).

When the AE-L/AF-L button is pressed during playback, the list by date screen can be displayed to play back only pictures shot on the same date (📖119).

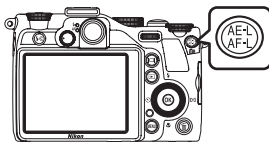

## Fn (FUNC) Button

Use the **Fn** button with the zoom control or shutter-release button.

- This can be used when **P, S, A, M, U1, U2** or **U3** is selected for shooting mode.

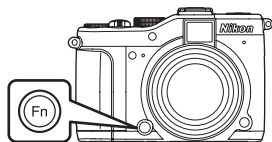

### Combined with the zoom control

When shooting, operate the zoom control while pressing the **Fn** button. This quickly changes to the zoom lens focal length that is set with **Zoom memory** (📖107) in the shooting menu.



### Combined with the shutter-release button

When shooting, press the shutter-release button while holding down the **Fn** button. You can shoot with the function setting that is assigned to **Fn button** (📖186) in the setup menu, without changing the shooting menu setting.

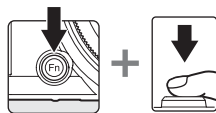

- In the default setting, no function is assigned.
- When the **Fn** button is pressed while a function is assigned, the **Fn** button operation indicator (📖6) and the icon for the assigned function are displayed.

## Rotary Multi Selector

Operate by rotating the rotary multi selector, pressing up (▲), down (▼), left (◀) or right (▶) on the rotary multi selector, or pressing the **OK** button.

### For Shooting

Rotate to set the exposure/  
Choose the option<sup>1</sup>

Display (flash mode)  
(32) menu/Choose  
the option above

Display (Self-timer/  
Smile timer/  
Remote control) menu  
(35, 36, 38)/Choose  
the option on the left

Display (AF area  
mode) menu<sup>2</sup>  
(84)/Choose the  
option on the right

Apply selection

Display (focus mode) menu (40)/Choose the option below

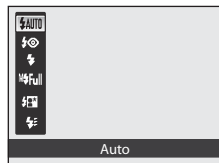

- <sup>1</sup> The aperture value or shutter speed can be set in shooting mode **S, A, M, U1, U2** or **U3** (63, 64, 65). Items can be chosen while a menu is displayed.
- <sup>2</sup> Displayed for **P, S, A, M, U1, U2** and **U3** modes, and (low noise night) mode.

### For Playback

Choose the previous  
picture\*

Choose the next  
picture\*

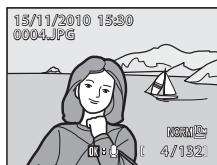

\* Previous or subsequent pictures can also be chosen by rotating the rotary multi selector.

### For Menu Screen

Choose the option above\*

Choose the option on  
the left\*/Return display  
to the previous screen

Choose the option  
below\*

Choose the option  
on the right\*/  
Display sub-menu  
or apply selection

Apply selection or  
display sub-menu

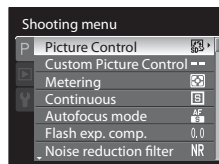

\* Items can also be chosen by rotating the rotary multi selector.

## MENU Button

Press the **MENU** button to display the menu and to select options for the menu items.

- Use the rotary multi selector to navigate the menus (📖12).
- Menu items can also be chosen by rotating the command dial.
- Select a tab on the left end of the monitor to display the corresponding menu (📖14).
- Press the **MENU** button again to exit the menu.

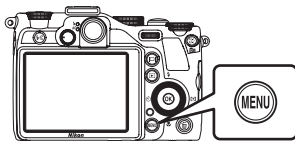

Displayed when the menu contains two or more pages

This tab displays the available menus in the mode selected with the mode dial.\*

This tab displays the playback menu.

This tab displays the setup menu.

Displayed when there are following menu options

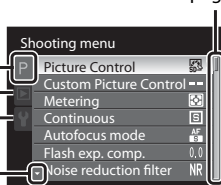

Displayed when there are previous menu options

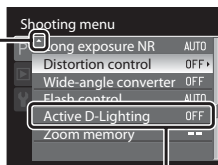

Choose an item, and then press the **OK** button or the rotary multi selector **▶** to proceed to the sub-menu.

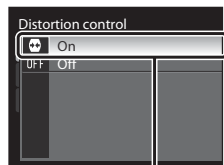

Press the **OK** button or the rotary multi selector **▶** to apply the selection.

\* The displayed tabs differ according to the chosen shooting mode.

- **(auto) mode**: Tabs are not displayed.
- **SCENE** (scene): Scene menu tab (📖45)
- **(low noise night)**: Low noise night menu tab (📖58)
- **P, S, A, M**: Shooting menu tab (📖90)
- **U1, U2, U3**: **U1, U2, U3** specialized menu tab (📖112), shooting menu tab on the second level
- **(movie)**: Movie menu tab (📖149)

## Switching Between Tabs in the Menu Screen

In the menu screen that is displayed when the **MENU** button is pressed (📖13), choose the left end tab to switch to the menu of the chosen tab.

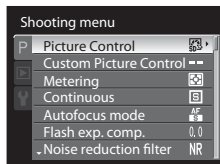

Press the rotary multi selector ◀ to highlight the tab.

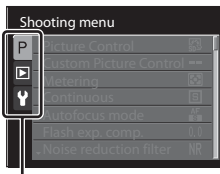

Press the rotary multi selector ▲ or ▼ to choose another tab, and press either the **OK** button or ▶.

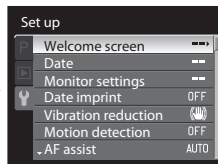

The corresponding menu is displayed.

## 📺 (Monitor) Button

To switch between the information displayed on the monitor during shooting and playback, press the 📺 (monitor) button.

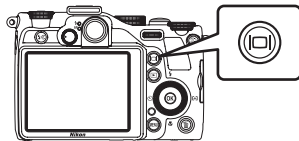

### For Shooting

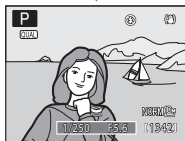

**Display information**  
Display the picture and the shooting data.



**Information hidden**  
Display the picture only.



**Monitor off**<sup>1,2</sup>  
Turn off the monitor.

### For Playback

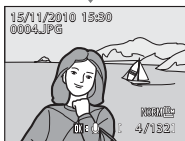

**Display photo information**  
Display the picture and the photo information.





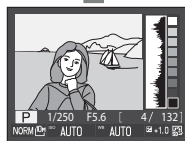

**Information hidden**  
Display the picture only.



**Tone level information**<sup>3</sup>  
(excluding movies)  
Display a histogram, and tone level and shooting information<sup>4</sup>.

- 1 Available when the mode dial is set to **P, S, A, M, U1, U2** or **U3**.
- 2 The shutter does not click when the focus is not locked and the AF lamp does not light up.
- 3 For details about the tone level information, see “Checking the Picture Brightness Distribution (**P, S, A, M** Modes)” (82).
- 4 The shooting information displayed includes the shooting mode **P, S, A** or **M**, shutter speed, aperture value, image quality, image size, ISO sensitivity, white balance, exposure compensation, COOLPIX picture control, and the current file number/total number of exposures.  
**P** is displayed when the shooting mode **SCENE** or **P** is chosen.

#### **Holding Down the Button and (Monitor Brightness Boost Indicator)**

Hold down the  button to set the monitor to the maximum brightness. To return the brightness to its original level, hold down the  button again or turn off the camera. When the brightness is set to the maximum with the ,  (monitor brightness boost indicator) is displayed on the monitor.

#### **Virtual Horizon, Histogram and Grid Displays for Shooting**

The display options for the monitor can be changed in **Photo info** (173) of **Monitor settings** in the setup menu. A virtual horizon, histogram and grid are available as the display options.

## Attaching the Camera Strap

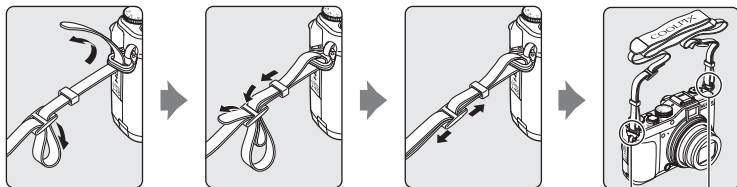

Attach the strap at two places.

## Charging the Battery

Charge the Rechargeable Li-ion Battery EN-EL14 (supplied) using the Battery Charger MH-24 (supplied).

### 1 Prepare the Battery Charger MH-24.

If a plug adapter\* is included, attach the plug adapter to the plug on the Battery Charger. Push the plug adapter firmly until it is securely held in place. Attempting to forcibly remove the plug adapter could damage the product.

\* The shape of the plug adapter varies according to the country or region in which the camera was purchased.

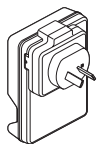
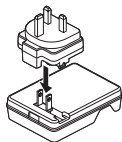
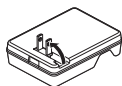

#### **For Customers in Argentina**

If the camera was purchased in Argentina, the plug adapter is already fixed onto the Battery Charger MH-24. Proceed to step 2.

### 2 While pushing in the battery (①), set it into the Battery Charger (②).

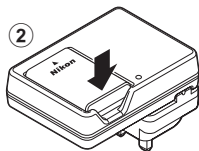
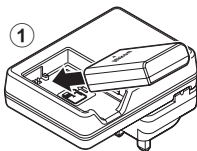

### 3 Plug the Battery Charger into an electrical outlet.

- CHARGE lamp starts blinking when charging starts.
- Charging is complete when the CHARGE lamp stops blinking.
- A fully-exhausted battery charges in about one hour and 30 minutes.
- The following chart explains CHARGE lamp status.

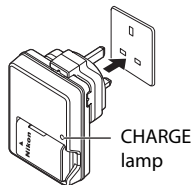

CHARGE lamp	Description
Blinks	Battery charging.
On	Battery fully charged.
Flickers	<ul style="list-style-type: none"> <li>The battery is set incorrectly. Disconnect the Battery Charger from the electrical outlet, remove the battery, and then reset the battery to lie flat in the Battery Charger.</li> <li>Operating temperature range exceeded. Charge the battery indoors while the ambient temperature is 5°C to 35°C (41°F to 95°F).</li> <li>The battery is faulty. Immediately disconnect the Battery Charger from the electrical outlet, and stop charging. Take the battery and Battery Charger to your retailer or Nikon-authorized service representative.</li> </ul>

#### 4 When charging is complete, remove the battery, and then disconnect the Battery Charger from the electrical outlet.

#### Notes on Battery Charger

- The supplied Battery Charger is for use only with a Rechargeable Li-ion Battery EN-EL14.
- Be sure to read and follow the warnings and cautions of “For Your Safety” (📖ii) thoroughly before using the Battery Charger.
- The MH-24 is compatible with AC 100-240 V, 50/60 Hz electrical outlets. When using in other countries, use a commercially available plug adapter as necessary. For more information about plug adapters, consult your travel agency.

#### Notes on Battery

- Be sure to read and follow the warnings and cautions of “For Your Safety” (📖ii) thoroughly before using the battery.
- Be sure to read and follow the warnings for “The Battery” (📖196) thoroughly before using the battery.
- If the battery will not be used for an extended period, recharge it at least once every six months and run it flat before returning it to storage.

#### Notes on AC Power Supply

- If the AC Adapter EH-5a and the Power Connector EP-5A (available separately) (📖199) are used, power is supplied to the camera from an electrical outlet, enabling taking and playing back pictures.
- Do not, under any circumstances, use an AC Adapter other than the EH-5a or a Power Connector other than the EP-5A. Failure to observe this precaution could result in overheating or in damage to the camera.

# Inserting the Battery

Insert a Rechargeable Li-ion Battery EN-EL14 (supplied) into the camera.

- Charge the battery before first use or when the battery is running low (📖16).

## 1 Open the battery-chamber/memory card slot cover.

- Slide the cover latch to the ◀ side (①), and open the cover (②).

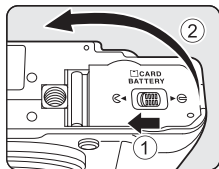

## 2 Insert the battery (supplied).

- Confirm that the positive (+) and negative (-) terminals are oriented correctly, as shown on the label at the entrance of the battery chamber, and insert the battery.
- Use the battery to push the orange battery latch in the direction shown (①), and fully insert the battery (②).
- When the battery is fully inserted, the battery latch locks it in place.

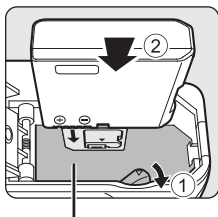

Battery chamber



## ✓ Inserting the Battery Correctly

**Inserting the battery upside down or backwards could damage the camera.** Be sure to confirm that the battery is in the correct orientation.

## 3 Close the battery-chamber/memory card slot cover.

- Close the cover (①), and slide the cover latch to the ▶ position (②).

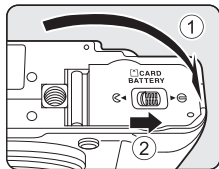



## Removing the Battery

Before opening the battery-chamber/memory card slot cover, turn the camera off (19) and confirm that the power-on lamp and the monitor are off.

To eject the battery, open the battery-chamber/memory card slot cover and slide the battery latch in the direction shown (1). Then, remove the battery straight (2).

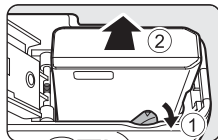

- Note that the battery or memory card may become hot during use; observe due caution when removing the battery.

## Turning On and Off the Camera

Press the power switch.

The power-on lamp (green) and the monitor are turned on (when the monitor is turned on, the power-on lamp turns off).

Press the power switch again to turn off the camera. When the power is turned off, the power-on lamp and monitor also turn off.

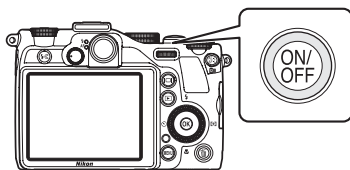

- When the camera is off, holding down the  button turns on the camera in playback mode (30).

### Standby Mode (Auto Off)

If no operations are performed, the monitor is turned off automatically, the camera enters standby mode and the power-on lamp blinks. The camera turns off when the standby mode continues for about three minutes.

- When the power-on lamp blinks, turn on the monitor again with one of the following operations.
  - Press the power switch, the shutter-release button or the  button.
  - Rotate the mode dial.
- During shooting or playback, if no operations are performed for about a minute (default setting), the camera enters standby mode.
- The time that elapses before the camera enters standby mode can be changed from the **Auto off** (181) in the setup menu (167).

# Setting the Display Language, Date and Time

Dialogs for language selection and camera clock setting are displayed the first time the camera is turned on.

1 Press the power switch to turn on the camera.

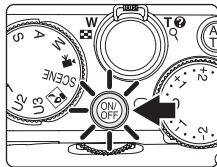

2 Use the rotary multi selector to choose the desired language and press the **OK** button.



- For information on using the rotary multi selector, see "Rotary Multi Selector" (📖12).



3 Choose **Yes** and press the **OK** button.

- If **No** is selected, the date and time are not set.

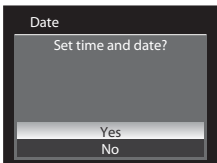

4 Press **◀** or **▶** to select your home time zone (Time zone) (📖172), and press the **OK** button.



## Daylight Saving Time

To set the date and time in a time zone where daylight saving is in effect, turn on the daylight saving setting with **▲** in the time zone selection screen shown in step 4.

- When turned on, the  icon is displayed on the top of the screen.
- To turn off, press **▼**.

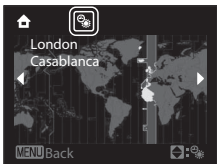

## 5 Set the date and time.

- To choose an item: Press ► or ◀ (selected in the following order: **D** (day) → **M** (month) → **Y** (year) → **hour** → **minute** → **DMY** (date display order)).
- To set the contents: Rotate the rotary multi selector, or press ▲ or ▼.
- YMD, MDY or DMY can be chosen for the order in which the day, month, and year are displayed.

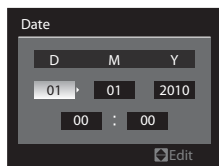

## 6 Finally, choose **DMY**, and apply the selection by pressing the **OK** button or ►.

- The clock starts. The lens extends and the monitor display reverts to shooting mode.



## Imprinting the Date and Changing the Date and Time

- To imprint the date on pictures when shooting, first set the date and time, and then set **Date imprint** (📖174) in the setup menu (📖167).
- To change the date and time of the camera clock, select **Date** in **Date** (📖170) of the setup menu. Follow the procedure described in step 5 above.
- Select **Time zone** from **Date** in the setup menu to change the time zone and daylight saving time settings (📖170).

# Inserting the Memory Card

The recorded data is stored in the camera's internal memory (approx. 79 MB) or on commercially available Secure Digital (SD) memory cards (📖221).

**If a memory card is inserted in the camera, data is automatically stored on the memory card, and data recorded to the memory card can be played back, deleted, or transferred. To use the internal memory, remove the memory card.**

- 1 Confirm that the power-on lamp and the monitor are turned off and open the battery-chamber/memory card slot cover.

- Be sure to turn off the camera before opening the battery-chamber/memory card slot cover.

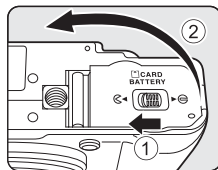

- 2 Insert the memory card.

- Slide the memory card in correctly as shown on the right, until it clicks into place.
- Close the battery-chamber/memory card slot cover after inserting the memory card.

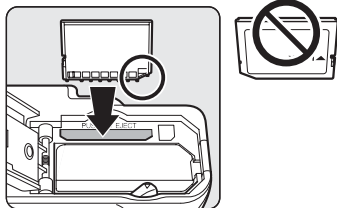

## ✓ Inserting the Memory Card Correctly

**Inserting the memory card upside down or backwards could damage the camera or the memory card.** Be sure to confirm that the memory card is in the correct orientation.

## Removing the Memory Card

Before opening the battery-chamber/memory card slot cover, turn the camera off and confirm that the power-on lamp and the monitor are off.

Press the memory card in lightly with your finger (①) to partially eject it, and then pull it out straight (②).

- Note that the battery or memory card may become hot during use; observe due caution when removing the battery.

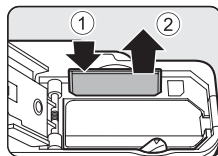

## ✓ Formatting a Memory Card

If the message on the right is displayed, the memory card must be formatted before use. **Note that formatting** (📖182)

**permanently deletes all pictures and other data on the memory card.** Be sure to make copies of any data you wish to keep before formatting the memory card.

To format, use the rotary multi selector to choose **Yes** and press the **OK** button. When the confirmation dialog is displayed, choose **Format** and press the **OK** button to start formatting.

- Do not turn the camera off, or open the battery-chamber/memory card slot cover until formatting is complete.
- The first time you insert a memory card that has been used in another device into this camera, be sure to format it (📖182) with this camera.

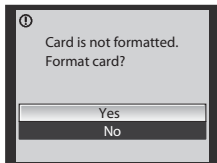

## ✓ The Write Protect Switch

Memory cards are equipped with a write protect switch. When this switch is in the "Lock" position, data cannot be written to, or deleted from, the memory card. If you want to record data, delete data or format the memory card, and the switch is in the "Lock" position, slide the switch to its original position to unlock it.

Write protect switch

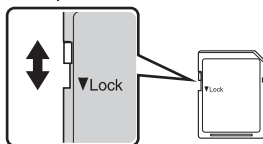

## ✓ Memory Cards

- Use only Secure Digital memory cards.
- Do not perform the following operations during formatting, while data is being written to or deleted from the memory card, or during data transfer to a computer. Failure to observe this precaution could result in the loss of data or in damage to the memory card:
  - Eject the memory card
  - Remove the battery
  - Turn off the camera
  - Disconnect the AC adapter
- Do not use a computer to format the memory card.
- Do not disassemble or modify.
- Do not drop, bend, or expose to water or strong physical shocks.
- Do not touch the metal terminals with your fingers or metal objects.
- Do not affix labels or stickers to the memory card.
- Do not leave in direct sunlight, closed vehicles or areas exposed to high temperatures.
- Do not expose to humidity, dust, or corrosive gases.

## Step 1 Turn the Camera On and Select (Auto) Mode

This section describes how to take pictures in  (auto) mode, an automatic, “point-and-shoot” mode recommended for first-time users of digital cameras.

### 1 Press the power switch to turn on the camera.

- The lens extends, and the monitor is turned on.

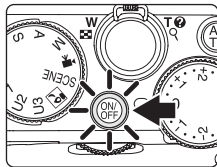

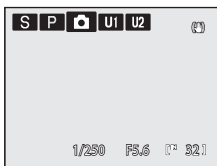
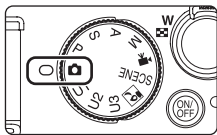

### 2 Rotate the mode dial to .



### 3 Check the battery level and number of exposures remaining on the monitor.

#### Battery Level

Monitor	Description
(NO INDICATOR)	Battery fully charged.
 (lights)	Battery level low; prepare to charge or replace the battery.
 Battery exhausted.	Cannot shoot. Recharge or replace with a fully-charged battery.

#### Battery level indicator

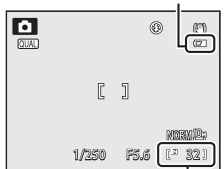

#### Number of exposures remaining

#### Number of Exposures Remaining

The number of exposures remaining is displayed.

The number of pictures that can be stored depends on the remaining capacity of the internal memory or memory card, the image quality, and the image size ( 71).

## Indicators Displayed in (Auto) Mode

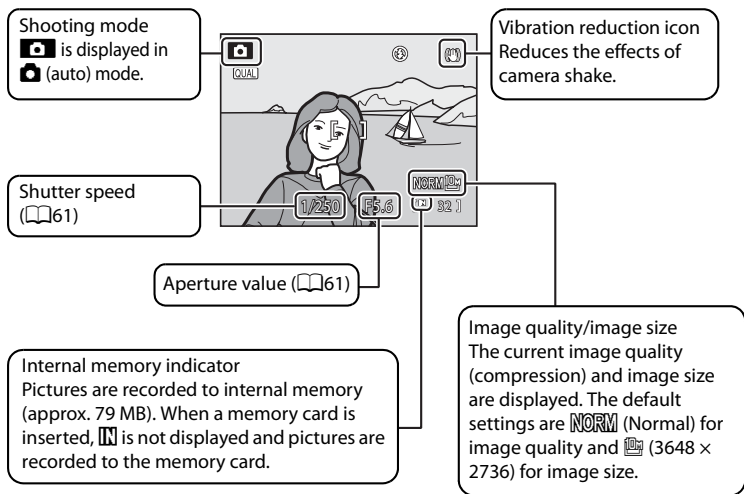

To turn on the monitor in the power save standby mode, press the power switch or shutter-release button (181).

### Note on the Flash

When the built-in flash is lowered, the flash setting is fixed to off and  appears at the top of the monitor. In situations where a flash is needed, such as in dark locations or when the subject is backlit, be sure to raise the built-in flash (33).

### Functions Available in (Auto) Mode

- Focus mode (40) and exposure compensation (43) can be applied and pictures can be taken using the flash mode (32) and self-timer (35).
- The image quality/image size can be changed by rotating the quick menu dial to **QUAL** and pressing the quick menu button (68).

### Vibration Reduction

- See **Vibration reduction** (175) in the setup menu (167) for more information.
- Set **Vibration reduction** to **Off** when using a tripod to stabilize the camera during shooting.

## Step 2 Frame a Picture

### 1 Ready the camera.

- Hold the camera steadily in both hands.
- Keep your fingers, hair, strap and other objects away from the lens, flash, AF-assist illuminator, microphone and speaker.
- When using the flash (📖32) to shoot in the “tall” orientation, hold the camera so that the flash is above the lens.

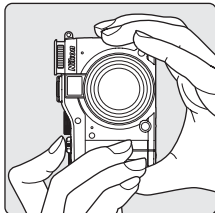
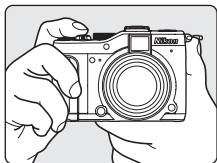

### 2 Frame the picture.

- Position the main subject near the center of the monitor.

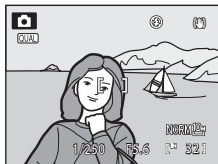

## Using the Viewfinder

Use the viewfinder to frame pictures when bright light makes it difficult to see the monitor.

When the image in the viewfinder is difficult to see, adjust by rotating the diopter adjustment control while looking through the viewfinder.

- Take care not to scratch your eye with your fingertips or nails.

### ✓ Notes on the Viewfinder

As the area visible in the viewfinder may differ from that of the final picture, use the monitor to frame pictures in the following situations:

- When shooting at ranges of about 2 m (6 ft. 7 in.) or less at the maximum telephoto position
- When a wide-angle converter lens is used (available separately from Nikon; 📖104)
- When the digital zoom is applied (📖27)
- When shooting at an **Image size** (📖70) of  $\frac{16}{9}$  3648×2432,  $\frac{16}{9}$  3584×2016 or  $\frac{1}{1}$  2736×2736

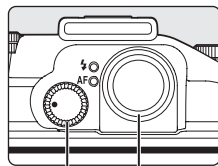

Diopter adjustment control      Viewfinder



## Using the Zoom

Rotate the zoom control to activate the optical zoom. Rotate in the **T** direction to zoom in so that the subject fills a larger area of the frame. Rotate in the **W** direction to zoom out so that the area visible increases in the frame.

- A zoom indicator is displayed at the top of the monitor when the zoom control is rotated.

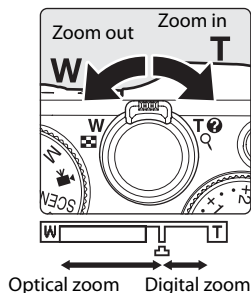

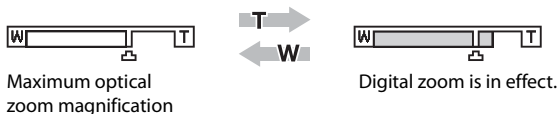

## Digital Zoom

When the camera is already at the maximum optical zoom magnification, rotating the zoom control in the **T** (telephoto) direction triggers the digital zoom. The subject can be magnified up to 4x the maximum optical zoom ratio. The focus will be on the center of the frame and the focus area will not be displayed when the digital zoom is in effect.



## Digital Zoom and Interpolation

Unlike the optical zoom, the digital zoom uses a digital imaging process known as interpolation to magnify images, resulting in slight deterioration of picture quality depending on the image size (170) and digital zoom magnification.

Interpolation is applied at zoom positions beyond . When the zoom is increased beyond the  position, interpolation is initiated and the zoom indicator also turns yellow to indicate that interpolation is being applied.

The position of  moves to the right as image size decreases, allowing for confirmation of the zoom positions at which shooting still pictures without interpolation is possible at the current image size setting.

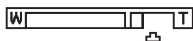

When the image size is small

- Using **Digital zoom** (178) in the setup menu (167), it is possible to restrict the magnification of the digital zoom to a range where images do not deteriorate, or to set the digital zoom so that it does not operate.

## More Information

- See "Zoom Memory" (107) for more Information.
- See "Zoom Speed" (179) for more Information.

## Step 3 Focus and Shoot

### 1 Press the shutter-release button halfway.

- When the button is pressed halfway (📖10), the camera focuses.
- The camera automatically focuses on the subject in the center focus area. When the subject is in focus, the focus area lights in green, and the AF lamp next to the viewfinder lights.
- When the digital zoom is in effect, the camera focuses on the subject in the center of the screen, and the focus area is not displayed. When the subject is in focus, the AF lamp lights in green.
- The focus and exposure remain locked while the shutter-release button is pressed halfway.
- When the shutter-release button is pressed halfway and the focus indicator blinks red or the AF lamp blinks rapidly, the camera is unable to focus. Change the composition and press the shutter-release button halfway again.

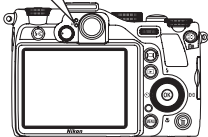
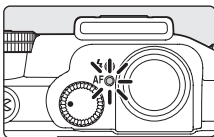
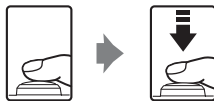

### 2 Press the shutter-release button the rest of the way down.

- The shutter is released and the picture is recorded to the memory card or internal memory.



## ✓ During Recording

While the AF lamp or the indicator showing the number of exposures remaining is blinking, images are being recorded. **Do not open the battery-chamber/memory card slot cover.** Cutting the power or removing the memory card in these circumstances could result in loss of data or in damage to the camera or card.

## ✓ Autofocus

Autofocus may not perform as expected in the following situations. In some rare cases, the subject may not be in focus despite the fact that the active focus area or focus indicator lights green:

- Subject is very dark
- Objects of sharply differing brightness are included in the scene (e.g. the sun behind the subject makes that subject appear very dark)
- No contrast between the subject and surroundings (e.g. a portrait subject, wearing a white shirt, is standing in front of a white wall)
- Several objects are at different distances from the camera (e.g., an animal inside a cage)
- Subjects that repeat the same pattern (e.g., as window blinds or buildings lined with windows of the same shape)
- Subject is moving rapidly

In the situations noted above, try pressing the shutter-release button halfway to refocus several times, or focus on another subject and use focus lock. When using focus lock, be sure that the distance between the camera and the subject with which focus was locked is the same as that for the actual subject.

The camera can also be focused using manual focus (📖42).

## 🔒 Focus Lock

Use focus lock to focus on off-center subjects when Center is selected for AF area mode.

- Be sure that the distance between the camera and the subject does not change.
- When the shutter-release button is pressed halfway, the exposure is locked.



Frame the subject to be focused on using the camera.



Press the shutter-release button halfway.



Confirm that the focus area is green.



Continue holding down the shutter-release button halfway and recompose the picture.



Press the shutter-release button the rest of the way down to shoot.

Instead of pressing the shutter-release button halfway, you can also press the AE-L/AF-L button to shoot with focus lock (📖11).











## 🔦 AF-assist illuminator

In dark places, the AF-assist illuminator (📖177) may light when the shutter-release button is pressed halfway.

## Step 4 Viewing and Deleting Pictures

### Viewing Pictures (Playback Mode)

Press the  (Playback) button.

- The last picture shot is displayed in full-frame playback mode.
- Rotate the rotary multi selector, or press , ,  or  to view previous or subsequent pictures. Continue holding down , ,  or  to fast forward pictures. Pictures can also be chosen by rotating the command dial.
- Pictures may be briefly displayed at low resolution immediately after switching to the previous or next picture.
- Press the  button or the shutter-release button to switch to shooting mode.
-  is displayed when pictures stored in the internal memory are displayed. When a memory card is inserted,  is not displayed and pictures stored on the memory card are displayed.

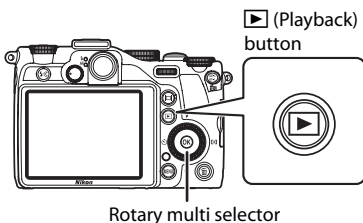

Rotary multi selector

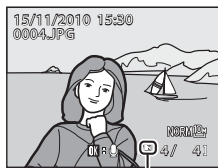

Internal memory indicator

#### When the Monitor Is Turned Off to Save Power

When the power-on lamp blinks, press the  button to turn on the monitor again (📖181).

#### Options Available in Playback Mode

For details, see "More on Playback" (📖115) or "Editing Pictures" (📖133).

#### Pressing the Button to Turn on the Camera

When the camera is off, holding down the  button turns on the camera in playback mode. The lens does not extend.

#### Viewing Pictures

- Press the  button to hide or show the shooting information and photo information on the monitor (📖14).
- Pictures taken in portrait ("tall") orientation will be rotated automatically (📖180). The rotating direction can be changed from the **Rotate image** option (📖130) in the playback menu (📖122).

## Deleting Unnecessary Pictures

- 1 Press the  button to delete the picture currently displayed on the monitor.

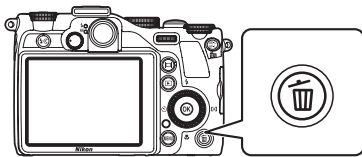

- 2 Use the rotary multi selector to choose **Yes** and press the  button.

- The picture that is deleted cannot be restored.
- To exit without deleting the picture, choose **No** and press the .

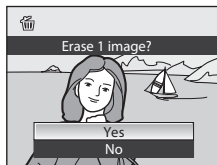

### Notes on Deletion

When images shot with an **Image quality** (📖68) setting of **NRW (RAW) + Fine**, **NRW (RAW) + Normal** or **NRW (RAW) + Basic** are deleted with the  button, both the NRW (RAW) and JPEG images that were recorded at the same time are deleted.

To delete only NRW (RAW) images or JPEG images, select **Erase selected NRW images** or **Erase selected JPEG images** in **Delete** (📖127) of the playback menu (📖122).

### Deleting the Last Picture Taken While in Shooting Mode

In shooting mode, press the  button to delete the last picture shot.

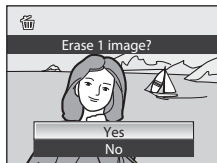

### Deleting Multiple Pictures

To delete multiple pictures, choose **Delete** (📖127) from the playback menu (📖122) or list by date menu (📖121).

## Using the Flash

In dark locations or when the subject is backlit, you can shoot pictures with a flash by raising the built-in flash. You can set a flash mode that suits the shooting conditions. The flash has a range of about 0.5 to 6.5 m (1 ft. 8 in. to 21 ft.) for wide, and about 0.8 to 3 m (2 ft. 8 in. to 9 ft. 10 in.) for tele (when **ISO sensitivity** is set to **Auto**).

### **Auto**

Flash fires automatically when lighting is poor.

### **Auto with red-eye reduction**

Reduces “red-eye” in portraits.

### **Off**

Flash does not fire.









- Available when the scene mode is  (scene auto selector) or a Speedlight (external flash unit) is attached.

### **Fill flash**

The flash fires when a picture is taken, regardless of how bright the subject is. Use to “fill-in” (illuminate) shadows and backlit subjects.

### **Manual**

Flash is forcibly fired at the flash output that is set for the built-in flash.

- Choose the flash output from  Full (full flash),  1/2,  1/4,  1/8,  1/16,  1/32 and  1/64. For example, when  1/16 is chosen, the flash is 1/16 of the full flash.
- Not available when a Speedlight flash unit (available separately) is attached.

### **Slow sync**









Fill flash is combined with a slow shutter speed.

Suitable for portraits of human subjects shot at night or under dim light. Flash illuminates main subject; slow shutter speeds are used to capture background.

### **Rear-curtain sync**

Fill flash fires just before the shutter closes, creating the effect of a stream of light behind moving subjects.

## **Flash Mode Setting**

- The default flash mode setting varies with the shooting mode ( 44).
  -  (auto) mode:  Auto
  - SCENE: Options vary depending on the scenes ( 46 to 55).
  - **P, S, A, M, U1, U2, U3**:  Auto
- This feature cannot be used simultaneously with certain features. See “Functions that Cannot be Applied Simultaneously” ( 108) for more information.
- In the following situations, the setting for flash mode is stored in the camera’s memory even after the camera is turned off.
  - When shooting mode **P, S, A** or **M** is used
  - When shooting with  (Auto with red-eye reduction) in  (auto) mode

## Setting the Flash Mode

### 1 Press the (flash pop-up) button.

- Built-in flash is raised.
- When the built-in flash is lowered, the flash mode is fixed to  (Off).

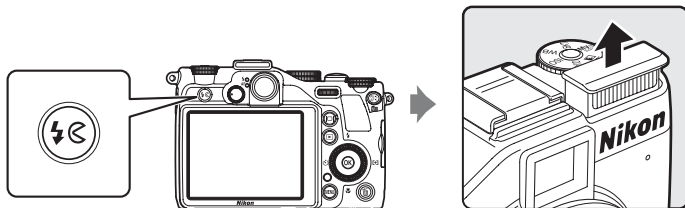



### 2 Press (flash mode) on the rotary multi selector.

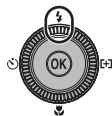



- The flash mode menu is displayed.

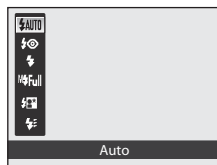

### 3 Use the rotary multi selector to choose the desired mode and press the button.

- When the manual flash is chosen, choose the flash output with  or  before pressing the  button.



- The mode selected for the flash is displayed.
- When  (Auto) is applied,  is only displayed for a few seconds even if monitor indicators ( 14) are turned on.
- If the  button is not pressed within a few seconds, the selection is set and the setting menu disappears.

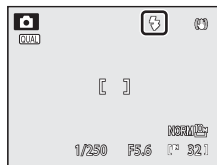

### Lowering the Built-in Flash

When not using the built-in flash, gently push to lower the flash until it clicks shut.

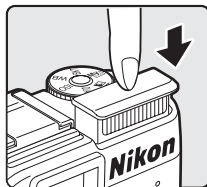

### ✓ Shooting When Lighting is Poor or When the Flash is Set to Ⓢ (Off)

- Use of a tripod is recommended to stabilize the camera during shooting and avoid the effects of camera shake. When the camera is stabilized with a tripod, set **Vibration reduction** (📖175) to **Off** in the setup menu (📖167).
- **ISO** may be displayed in the shooting mode. When **ISO** is displayed, the ISO sensitivity has increased automatically.
- When shooting at slow shutter speeds in dark location, the noise reduction function may operate. When the noise reduction function operates, it may take more time to save images.

### ✓ Note on Using the Flash

Reflections from dust particles in the air may appear as bright spots in pictures. To reduce these reflections, set the flash to Ⓢ (Off), or shoot pictures with the built-in flash lowered.

#### 🔧 Flash Lamp

The flash lamp shows the flash status when the shutter-release button is pressed halfway down.

- On: Flash fires when picture is shot.
- Blinks: Flash is charging. Wait a few seconds and try again.
- Off: Flash does not fire when picture is shot.

When the battery level is low, the monitor is turned off during charging of the flash.

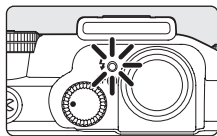

#### 🔧 Auto with Red-eye Reduction

This camera uses **advanced red-eye reduction (“In-Camera Red-Eye Fix”)**.

Pre-flashes are fired repeatedly at low intensity before the main flash, reducing the red-eye effect.

If the camera detects “red-eye” when a picture is taken, Nikon’s own In-Camera Red-Eye Fix processes the image before it is recorded.

Note the following when taking pictures:

- Because pre-flashes are fired, there is a slight lag between when the shutter-release button is pressed and when the picture is shot.
- The time required to save the picture increases slightly.
- Advanced red-eye reduction may not produce the desired results in some situations.
- In extremely rare instances, areas not subject to red-eye may be affected by advanced red-eye reduction processing. In these cases, choose another mode and try again.
- The red-eye reduction process when NRW (RAW) images (📖68) are recorded consists only of the pre-flashing before the main flash (including the JPEG image that is recorded at the same time).

When **Red-eye reduction** (📖177) in the setup menu is set to **Pre-flash off**, the shutter is released immediately when the shutter-release button is fully pressed, without firing the pre-flashes before the main flash.

#### 🔍 More Information

See “Using Speedlights (External Flash Unit)” (📖202) for more Information.



## Taking Pictures with the Self-Timer

The self-timer is suitable for taking group pictures and reducing the vibration when the shutter-release button is pressed. Timer durations of two or ten seconds can be selected.



When using the self-timer, use of a tripod is recommended. Set **Vibration reduction** (📖175) in the setup menu (📖167) to **Off** when using a tripod to stabilize the camera.

### 1 Press (self-timer) on the rotary multi selector.

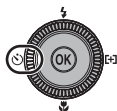
- The self-timer menu is displayed.



### 2 Use the rotary multi selector to choose 10s or 2s and press the button.

-  10s (ten seconds): suitable for group pictures.
-  2s (two seconds): suitable for preventing camera shake.
- The mode selected for the self-timer is displayed.
- If the  button is not pressed within a few seconds, the selection is set and the setting menu disappears.



### 3 Frame the picture and press the shutter-release button halfway.

- The focus and exposure are set.

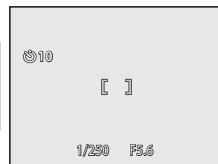

### 4 Press the shutter-release button the rest of the way down.

- The self-timer starts, and the number of seconds remaining before the shutter is released is displayed. The self-timer lamp blinks while the timer is counting down. About one second before the shutter is released, the lamp stops blinking and remains lit.
- When the shutter is released, the self-timer turns **Off**.
- To stop the timer before a picture is taken, press the shutter-release button again.

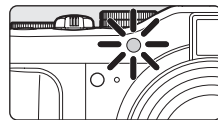
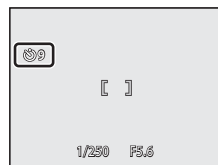

## Taking Pictures of Smiling Faces (Smile Timer)

The camera detects smiling faces using face detection and releases the shutter automatically. The skin softening function makes a human subject's skin appear smoother.

This can be used when the shooting mode (📖44) is 📷 (auto) mode, the **Portrait** or **Night portrait** scene mode, or **P, S, A, M, U1, U2, U3** or 📷 (low noise night) mode.

### 1 Press ⏱ (self-timer) on the rotary multi selector.

- The self-timer menu is displayed.
- Change any flash mode, exposure compensation, or shooting menu settings before pressing the ⏱ button.

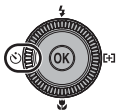

### 2 Use the rotary multi selector to choose 📷 (Smile timer), and press the OK button.

- If the OK button is not pressed within a few seconds, the selection is set and the setting menu disappears.

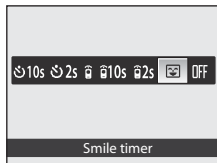

### 3 Frame the picture.

- Point the camera at the subject.
- When the camera detects a face, the focus area containing the face is displayed with a double border.
- Up to three faces can be detected. When more than one face is detected, the face closest to the center of the frame is framed by a double border and the others by single borders.

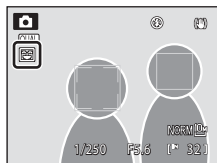





### 4 Press the shutter-release button fully.

- The camera begins searching for smiling faces, and when the camera detects a smiling face of the subject framed by the double border, the shutter is released automatically.
- Each time the shutter is released, automatic shooting using face detection and smiling face detection is repeated.

## 5 Press the shutter-release button when the required pictures have been taken.

- Automatic shooting ends.
- Shooting also ends in the situations below.
  - When 12 pictures have been taken
  - When five minutes have passed since pressing the shutter-release button in step 4 and no smiling faces have been detected

### Notes on Smile timer

- The digital zoom is not available.
- When the smile timer is selected, the monitor is not turned off even when the  button is pressed (14).
- Under some shooting conditions, faces and smiling faces may not be detected properly.
- See “Notes on Face Priority” (87) for more information.
- This feature cannot be used simultaneously with certain features. See “Functions that Cannot be Applied Simultaneously” (108) for more information.

### Notes on Skin Softening

- In images taken with the Smile timer, the camera makes the subject’s skin appear smoother (up to three people), and then records the image (Skin softening function). This means that the image recording time is longer than usual.
- Depending on shooting conditions, even if the camera detects a face on the monitor at the time of shooting, effects of the skin softening function may not be visible, and areas other than the face may be processed.
- The extent of skin softening effect that is applied cannot be set.
- Skin softening can also be applied to pictures after they have been taken (139).

### Operation of the Self-Timer Lamp for Smile timer

When the camera detects a face after the shutter-release button is pressed in step 4, the self-timer lamp blinks. Immediately before the shutter is released, the self-timer lamp turns off.

### More Information

See “Autofocus” (29) for more information.

# Shooting with Remote Control

Use the remote control ML-L3 (available separately) (📖200) to release the shutter. It is convenient for taking self-portraits and effectively eliminates blur caused by camera shake that occurs when the shutter-release button is pressed.



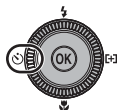

- Use of a tripod is recommended during shooting with the remote control. Set **Vibration reduction** (📖175) in the setup menu (📖167) to **Off** when using a tripod to stabilize the camera.

## 1 Press (self-timer) on the rotary multi selector.

- The self-timer menu is displayed.



## 2 Choose Remote control mode using the rotary multi selector and press the button.

-  (quick-response remote): Press the send button on the remote control to shoot instantly.
-  10s (ten seconds remote): Press the send button on the remote control to shoot ten seconds after the camera has focused.
-  2s (two seconds remote): Press the send button on the remote control to shoot two seconds after the camera has focused.
- The icon for the selected remote control mode is displayed.
- If the  button is not pressed within a few seconds, the selection is set and the setting menu disappears.

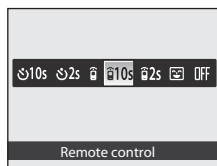

## 3 Frame the picture.

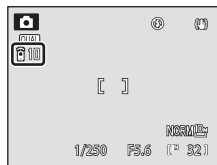

#### 4 Aim the transmitter at the infrared receiver on the front or rear of the camera (📖4, 5) and press the send button.

- Press the send button from a distance of 5 m (16 ft.) or less.
- In the quick-response remote mode, once the subject is in focus, the shutter is released.
- In ten seconds or two seconds remote mode, the self-timer lamp blinks when the subject is in focus, and then about one second before the shutter is released, the lamp stops blinking and remains lit. To stop the timer before a picture is taken, press the send button again.
- When the shutter is released in ten seconds or two seconds remote mode, the remote control mode turns to **Off**.

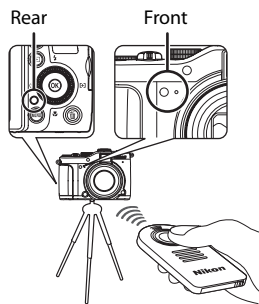

#### ✔ **Note on the Remote Control**

When shooting with **Continuous** or **BSS**, or the **Sports** or **Museum** scene mode, press the shutter-release button to shoot. Press the send button on the remote control to shoot one picture at a time.

# Using Focus Mode



Choose a focus mode according to the subject and composition.

## AF Autofocus

The camera automatically adjusts the focus according to the distance to the subject. Use when the distance from the subject to the lens is 50 cm (1 ft. 8 in.) or more, or 80 cm (2 ft. 8 in.) or more at the maximum telephoto position.

## Macro close-up

Use for close-ups of flowers or small objects.

When the  mark on the monitor lights in green (when the zoom indicator is to the wide-angle side of the  icon), the camera can focus on subjects as close as about 2 cm (0.8 in.) from the lens. The closest distance at which the camera can focus varies depending on the zoom position.

## Infinity





Use when shooting distant scenes through window glass or when shooting landscapes.

When the shutter-release button is pressed halfway, the AF lamp always lights in green. However, the camera may not be able to focus on nearby objects. The flash mode is set to  (Off).

## MF Manual focus

The focus can be adjusted for any subject that is a distance of 2 cm (0.8 in.) to infinity from the lens (42).

## Focus Modes Available in Each Shooting Mode

		P, S, A, M, U1, U2, U3	SCENE		
AF (Autofocus)	✓ <sup>1</sup>	✓ <sup>1</sup>	2	✓ <sup>1</sup>	✓ <sup>1</sup>
 (Macro close-up)	✓	✓		✓	✓
 (Infinity)	✓	✓		✓	✓
MF (Manual focus)	–	✓		✓	–

1 Default setting for each shooting mode.

2 Available focus modes and default setting vary between different scene modes (46 to 55).

## Focus Mode Setting

- For shooting modes **P**, **S**, **A** and **M**, the changed focus mode setting is stored in the camera's memory even after the camera is turned off.
- This feature cannot be used simultaneously with certain features. See "Functions that Cannot be Applied Simultaneously" (108) for more information.



## Setting the Focus Mode

1 Press  (focus mode) on the rotary multi selector.

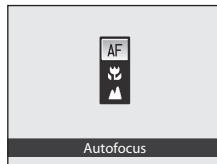
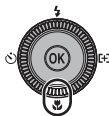
- The focus mode menu is displayed.





2 Use the rotary multi selector to choose the desired focus mode and press the  button.



- The mode selected for focus mode is displayed.
- When **AF** (Autofocus) is applied, **AF** is only displayed for a few seconds even if monitor indicators ( 14) are turned on.
- If the  button is not pressed within a few seconds, the selection is set and the setting menu disappears.



### Macro Close-up

When using **P, S, A, M, U1, U2** or **U3** mode, or  (movie) mode, if **Autofocus mode** ( 102) in the shooting menu is set to **Full-time AF**, the camera will continually focus until you press the shutter-release button halfway and the focus locks. A sound will be heard while the camera focuses. When using other shooting modes, **Full-time AF** is turned on automatically when macro mode is turned on.

### Infinity

If you set focus mode to infinity while using  (auto) mode, **P, S, A, M, U1, U2** or **U3** mode, or  (low noise night) mode, the focus area does not appear on the screen.

## Using Manual Focus



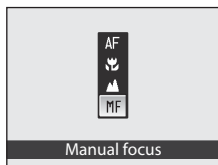
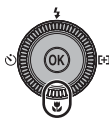

Available when the shooting mode is **P, S, A, M, U1, U2, U3** or  (low noise night). Select a shooting mode with the mode dial (📖44).

### 1 Press (focus mode) on the rotary multi selector to display the setup menu for focus mode.

- Use the rotary multi selector to choose **MF** (manual focus) and press the  button.
- **MF** is displayed on the top of the screen, and the image area and the enlarged center of the picture are displayed at the same time.



### 2 Adjust the focus.

- Use the rotary multi selector to adjust the focus while viewing the image on the monitor.
- Press  to focus on far subjects.
- Press  to focus on near subjects.
- When  is pressed, first the camera is focused with autofocus, and then the manual focus can be operated. Choose **Yes** and press the  button to focus on the subject in the center of the screen with autofocus.
- Press the shutter-release button halfway to check the composition. Press the shutter-release button the rest of the way down to take the picture.



### 3 Press the button.

- The set focus is locked. You can continue shooting with the locked focus.
- To readjust the focus, press the  button again to display the screen in step 2.
- To change back to autofocus, return to step 1 and choose any setting other than **MF**.

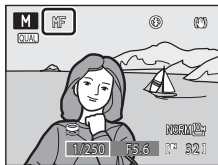

### **MF (Manual Focus)**

- Press the shutter-release button halfway to preview an approximate depth of field (the area in focus behind and in front of the subject).
- The digital zoom is not available.
- Focus mode changes to **AF** (Autofocus) when the monitor is turned off.



# Adjusting the Brightness (Exposure Compensation)

When exposure compensation is set for shooting, the brightness of the entire image can be adjusted to make it brighter or darker.

## 1 Select the compensation value by rotating the exposure compensation dial.

- To make the subject brighter: adjust the exposure compensation to the "+" side.
- To make the subject darker: adjust the exposure compensation to the "-" side.
- When set to a value other than **0.0**, the  mark and compensation value are displayed on the monitor and the exposure compensation dial mark turns on when shooting.

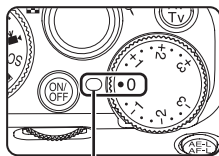

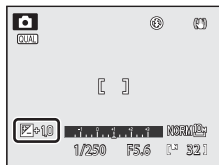

Exposure compensation dial mark



## 2 Press the shutter-release button to take the picture.

### Exposure Compensation Value

When the shooting mode is **M** (manual) mode ()65) and the scene mode is **Fireworks show** ()54), the exposure compensation cannot be used.

## Selecting a Shooting Mode (Mode Dial)

When the mode dial is rotated next to the mark, the camera switches to the corresponding shooting mode shown below.

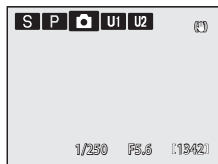
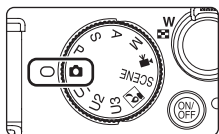

### P, S, A, M (160)

Choose these modes for greater control over shutter speed and aperture value.

### Auto mode (24)

An automatic, “point-and-shoot” mode recommended for first-time users of digital cameras.

### U1, U2, U3 User settings (112)

Up to three setting combinations that are frequently used for shooting can be saved in U1, U2 and U3. The saved settings can be immediately retrieved for shooting simply by rotating the mode dial to U1, U2 or U3.

### Movie mode (146)

High-definition movies can be shot with sound.

### SCENE Scene (45)

Shoot with settings suitable for the scene simply by choosing one of the scene modes. In scene auto selector mode, the camera automatically selects the optimum scene mode for simpler shooting.

### Low noise night mode (58)

Shoot with the ISO sensitivity controlled automatically to a high level and without the flash, to capture the atmosphere of a low-lit scene.

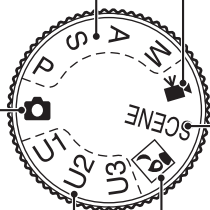

## Selecting Scenes for Shooting (Scene Mode)

You can shoot with settings suitable for the scene simply by choosing one of the following scene modes.

Scene auto selector	Party/indoor	Night landscape	Copy
Portrait	Beach	Close-up	Backlighting
Landscape	Snow	Food	Panorama assist
Sports	Sunset	Museum	
Night portrait	Dusk/dawn	Fireworks show	

### Setting the Scene Mode

#### 1 Rotate the mode dial to SCENE.

- The camera enters scene mode. The default setting is (scene auto selector).

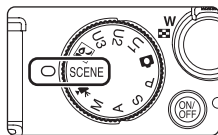

#### 2 Press the MENU button to display the scene menu screen, choose the desired scene with the rotary multi selector and press the OK button.

- Switch to the tab when the scene menu is not displayed (14).
- See “Selecting a Scene Mode to Take Pictures (Features)” (48) for more information.



#### 3 Frame the subject and take the picture.

- For scene modes that use the flash, be sure to press the (flash pop-up) button to raise the built-in flash before shooting.



### Image Quality and Image Size

- Rotate the quick menu dial to **QUAL** and press the quick menu button to set **Image quality** (68) and **Image size** (70). The setting is also applied to other shooting modes (except for low noise night mode, and shooting modes **U1**, **U2** and **U3**).
- NRW (RAW) images cannot be recorded in scene mode.

### Displaying the Scene Descriptions (Help Displays)

Choose a scene type in the scene menu (step 2) and rotate the zoom control to **T** (Help) to display the description of the scene. To return to the original screen, rotate the zoom control again to **T** (Help).

## Shooting in the Scene Selected by the Camera (Scene Auto Selector)

By simply framing a picture, the camera automatically selects the optimum scene mode for simpler shooting. When the camera is aimed at a subject in **Scene auto selector** mode, the camera automatically selects one of the following scene modes.

- Auto (general shooting)
- Portrait
- Landscape
- Night portrait
- Night landscape
- Close-up
- Backlighting

### 1 Rotate the mode dial to SCENE.

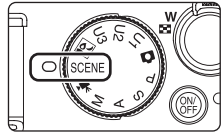

### 2 Press the MENU button to display the scene menu, choose Scene auto selector with the rotary multi selector and press the OK button.

- Scene auto selector is enabled.
- When the built-in flash is not raised, the message **The flash is lowered.** is displayed.
- Press the **Flash pop-up** button to raise the built-in flash.

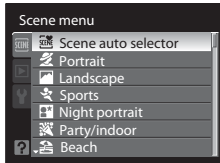

### 3 Frame the subject and take the picture.

- When the camera automatically selects a scene mode, the shooting mode icon changes to that for the scene mode currently enabled.

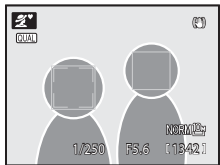



- Press the shutter-release button halfway to set the focus and exposure. When the subject is in focus, the focus area (active focus area) lights in green.
- Press the shutter-release button the rest of the way down to take the picture.





**✓ Notes on Scene Auto Selector**

- The digital zoom is not available.
- Depending upon shooting conditions, the camera may not select the desired scene mode. Should this occur, switch to  (Auto) mode (124) or choose the desired scene mode manually (148).

**📎 Focusing in Scene Auto Selector**

- In scene auto selector, the camera detects and focuses on a face (see “Shooting with Face Priority” (86) for more information).
- When the shooting mode icon is  or  (close-up), in the same way as when the AF area mode (84) is set to **Auto**, the camera automatically selects one or more of the nine focus areas containing the subject closest to the camera.

**📎 Note on Flash**



-  **AUTO** (Auto) (default setting) or  (Off) flash mode settings (132) can be applied.
  - When  **AUTO** (Auto) is applied, the camera automatically chooses the optimum flash mode setting for the scene mode it has selected.
  - When  (Off) is set, the flash does not fire even when the built-in flash is raised.
- If you do not want to use the built-in flash, you can shoot while the built-in flash is lowered.

**📎 Functions Available in Scene Auto Selector**

- Self-timer (135) and exposure compensation (143) settings can be adjusted.
- The  (focus mode) button (12, 40) and  (AF area mode) button (12, 84) on the rotary multi selector are not available.

## Selecting a Scene Mode to Take Pictures (Features)

See “Shooting in the Scene Selected by the Camera (Scene Auto Selector)” (📖 46) for more information on Scene auto selector scene mode.

- The  shown for each scene is the setting for the flash mode when the built-in flash is raised (📖32).  is the setting for the self-timer (📖35), remote control (📖38) and Smile timer (📖36), and  is the setting for focus mode (📖40).

### Portrait

Use this mode for taking portraits in which the main subject stands out clearly.

- The camera automatically detects and focuses on a face (see “Shooting with Face Priority” (📖86) for more information).
- If the camera detects multiple faces, the camera focuses on the face closest to the camera.
- After the skin softening feature makes the subject’s skin appear smoother (up to three people), the camera records the image (📖37).
- If no face is recognized, the camera focuses on the subject in the center of the frame.
- The digital zoom is not available.



\* Other settings can be selected.

### Landscape

Use this mode for vivid landscapes and cityscapes.



- The camera focuses at infinity. When the shutter-release button is pressed halfway, the AF lamp always lights in green. However, because the camera focuses at infinity, it may not be able to focus on nearby objects.
- AF-assist illuminator (📖177) does not light.



\* The self-timer and remote control are available.

### Sports

Use this mode for dynamic action shots that freeze the action in a single shot and record motion in a series of pictures. With continuous shooting, instantaneous movements of moving subjects can be captured clearly.

- The camera focuses on the subject in the center of the frame. The camera continuously focuses using autofocus until you press the shutter-release button halfway to lock the focus.
- While the shutter-release button is fully held down, up to 45 pictures are shot at a rate of about 1.3 frames per second (fps) when Image quality is set to **Normal** and Image size is set to  **3648x2736**.
- Focus, exposure compensation, and white balance are fixed at values determined with the first shot in each series.
- The frame rate with continuous shooting may vary, depending upon the current image quality setting, image size setting, and the memory card used.
- AF-assist illuminator ( 177) does not light.



Off





AF\*

\* MF (manual focus) can be selected.

### Night portrait



Use this mode for portraits of a human subject shot in front of background lighting at night. Flash is used to illuminate the subject while maintaining the mood of the background.

- Shoot pictures with the built-in flash raised.
- The camera automatically detects and focuses on a face (see “Shooting with Face Priority” ( 86) for more information).
- If the camera detects multiple faces, the camera focuses on the face closest to the camera.
- After the skin softening feature makes the subject’s skin appear smoother (up to three people), the camera records the image ( 37).
- If no face is recognized, the camera focuses on the subject in the center of the frame.
- The digital zoom is not available.





Off<sup>2</sup>





AF

1 Fixed to fill flash with slow sync and red-eye reduction.

2 Other settings can be selected.

: Indicates a tripod is recommended when using this scene mode. Turn **Vibration reduction** ( 175) to **Off** when using a tripod.

: Noise reduction is performed for pictures shot in scene modes with , so they may take longer to record.

## Selecting Scenes for Shooting (Scene Mode)

### Party/indoor

Suitable for taking pictures in parties. Captures the effects of candlelight and other indoor background lighting.

- The camera focuses on the subject in the center of the frame.
- Hold the camera steadily as pictures are easily affected by camera shake. When shooting under low lighting, use of a tripod is recommended. Set **Vibration reduction** (📖175) to **Off** when using a tripod to stabilize the camera during shooting.



Off<sup>2</sup>



AF

- 1 May automatically switch to slow sync with red-eye reduction. Other settings can be selected.
- 2 The self-timer and remote control are available.

### Beach

Captures the brightness of such subjects as beaches, or sunlit expanses of water.

- The camera focuses on the subject in the center of the frame.



Off<sup>2</sup>



AF

- 1 Other settings can be selected.

- 2 The self-timer and remote control are available.

### Snow

Captures the brightness of such subjects as sunlit snowfields.

- The camera focuses on the subject in the center of the frame.



Off<sup>2</sup>



AF

- 1 Other settings can be selected.

- 2 The self-timer and remote control are available.



### Sunset



Preserves the deep hues seen in sunsets and sunrises.

- The camera focuses on the subject in the center of the frame.



 AUTO<sup>1</sup>



Off<sup>2</sup>



AF

1 Other settings can be selected.

2 The self-timer and remote control are available.

### Dusk/dawn



Preserves the colors seen in the weak natural light before sunrise or after sunset.

- The camera focuses at infinity. When the shutter-release button is pressed halfway, the AF lamp always lights in green. However, because the camera focuses at infinity, it may not be able to focus on nearby objects.
- AF-assist illuminator ( 177) does not light.



Off<sup>\*</sup>



\* The self-timer and remote control are available.

### Night landscape



Slow shutter speeds are used to produce stunning night landscapes.



- The camera focuses at infinity. When the shutter-release button is pressed halfway, the AF lamp always lights in green. However, because the camera focuses at infinity, it may not be able to focus on nearby objects.
- AF-assist illuminator ( 177) does not light.





Off<sup>\*</sup>



\* The self-timer and remote control are available.



: Indicates a tripod is recommended when using this scene mode. Turn **Vibration reduction** ( 175) to **Off** when using a tripod.

: Noise reduction is performed for pictures shot in scene modes with , so they may take longer to record.











## Selecting Scenes for Shooting (Scene Mode)

### Close-up

Photograph flowers, insects and other small objects at close range.

- The focus mode () setting is changed to  (Macro close-up) and the camera automatically zooms to the closest position at which it can focus.



- When the  mark on the monitor lights in green (when the zoom indicator is to the wide-angle side of the  icon), the camera can focus on subjects as close as about 2 cm (0.8 in.) from the lens. The closest distance at which the camera can focus varies depending on the zoom position.
- AF area mode is changed to **Manual** to enable the focus area to be chosen (84). Press the  button, and then rotate the rotary multi selector, or press , ,  or  to move the focus area. When the focus area position is set by pressing the  button, the flash mode, self-timer or exposure compensation settings can be adjusted.
- The camera continuously focuses using autofocus until you press the shutter-release button halfway to lock the focus.
- As pictures are easily affected by camera shake, be sure that **Vibration reduction** (175) is enabled and hold the camera steadily.

	 AUTO <sup>1</sup>		Off <sup>2</sup>		
---	---	---	------------------	---	---

- 1 Other settings can be selected. Note that when shooting with the flash, the flash may be unable to light the entire subject at distances of less than 50 cm (1 ft. 8 in.).
- 2 The self-timer and remote control are available.

### Food

Use this mode when taking pictures of food.

- The focus mode (📖40) setting is changed to 🌸 (Macro close-up) and the camera automatically zooms to the closest position at which it can focus.



- When the 🌸 mark on the monitor lights in green (when the zoom indicator is to the wide-angle side of the △ icon), the camera can focus on subjects as close as about 2 cm (0.8 in.) The closest distance at which the camera can focus varies depending on the zoom position.
- You can adjust hue within a slider display at the left of the monitor. Pressing ▲ increases the red hue, and pressing ▼ increases the blue hue. The hue adjustments are stored in the camera's memory even after the camera is turned off.



- AF area mode is changed to **Manual** to enable the focus area to be chosen (📖84). Press the OK button, and then rotate the rotary multi selector, or press ▲, ▼, ◀ or ▶ to move the focus area. When the focus area position is set by pressing the OK button, the hue adjustment, self-timer and exposure compensation settings can be adjusted.
- The camera focuses continuously until focus is locked by pressing the shutter-release button halfway.
- As pictures are easily affected by camera shake, be sure that **Vibration reduction** (📖175) is enabled and hold the camera steadily.



\* The self-timer and remote control are available.

## Selecting Scenes for Shooting (Scene Mode)

### Museum

Use indoors where flash photography is prohibited (for example, in museums and art galleries) or in other situations in which you do not want to use the flash.

- The camera focuses on the subject in the center of the frame.
- BSS (Best Shot Selector) (📖99) can be used for shooting.
- As pictures are easily affected by camera shake, be sure that **Vibration reduction** (📖175) is enabled and hold the camera steadily.
- AF-assist illuminator (📖177) does not light.



Off<sup>1</sup>



AF<sup>2</sup>

1 The self-timer and remote control are available.

2  (Macro close-up) can be selected.

### Fireworks show



Slow shutter speeds are used to capture the expanding burst of light from fireworks.

- The camera focuses at infinity. When the shutter-release button is pressed halfway, the AF lamp always lights in green. However, because the camera focuses at infinity, it may not be able to focus on nearby objects.
- Exposure compensation (📖43) cannot be used.
- AF-assist illuminator (📖177) does not light.



Off\*



\* The quick-response remote is available.

### Copy

Provides clear pictures of text or drawings on a white board or in print.

- The camera focuses on the subject in the center of the frame.
- Use  (Macro close-up) mode (📖40) in focus mode with this mode to shoot pictures at close distances.
- Colored text and drawings may not show up well.



📖AUTO<sup>1</sup>



Off<sup>2</sup>



AF<sup>3</sup>

1 Other settings can be selected.

2 The self-timer and remote control are available.

3  (Macro close-up) can be selected.

: Indicates a tripod is recommended when using this scene mode. Turn **Vibration reduction** (📖175) to **Off** when using a tripod.

### Backlighting

Use to “fill-in” (illuminate) shadows and backlit subjects. The flash fires automatically to “fill in” (illuminate) shadows.

- Shoot pictures with the built-in flash raised.
- The camera focuses on the subject in the center of the frame.



			Off <sup>*</sup>		AF
---	---	---	------------------	---	----

\* The self-timer and remote control are available.

### Panorama assist





Use when shooting a series of pictures that can later be joined on a computer to form a single panorama, using the supplied Panorama Maker 5 software. See “Taking Pictures for a Panorama” (📖56) for more information.

	 AUTO <sup>1</sup>		Off <sup>2</sup>		AF <sup>3</sup>
---	---	---	------------------	---	-----------------

1 Other settings can be selected.

2 The self-timer and remote control are available.

3  (Macro close-up) or  (Infinity) can be selected.

## Taking Pictures for a Panorama

The camera focuses on the subject in the center of the frame. Using a tripod makes the composition easier. When the camera is stabilized with a tripod, set **Vibration reduction** (📖175) to **Off** in the setup menu (📖167).

### 1 Rotate the mode dial to SCENE.

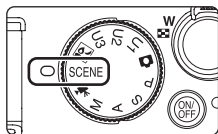



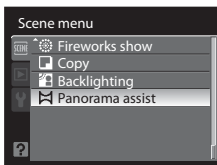



### 2 Press the MENU button to display the scene menu screen, choose **Panorama assist** with the rotary multi selector and press the OK button.



- The  icon is displayed to show the direction in which pictures are joined.

### 3 Use the rotary multi selector to choose the direction and press the OK button.

- Select the direction in which pictures are joined in the completed panorama: right () , left () , up () or down () .
- The yellow icon () moves to the direction pressed, so press the OK button to choose the direction. A white icon () is displayed in the chosen direction.
- Apply flash mode (📖32), self-timer (📖35)/remote control (📖38), focus mode (📖40) and exposure compensation (📖43) settings with this step, if necessary.
- Press the OK button again to reselect the direction.

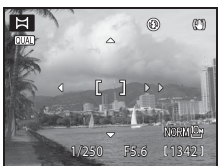

### 4 Shoot the first picture in the panorama series.

- The picture taken is displayed in 1/3 of the monitor.

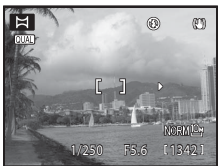

## 5 Shoot the second picture.

- Match the outline of the next picture so that 1/3 of the frame overlaps the previous picture, and press the shutter-release button.
- Repeat until you have taken the necessary number of pictures to complete the image.



## 6 Press the **OK** button when shooting is completed.

- The camera returns to step 3.

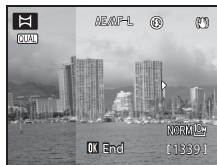

## **✓** Panorama Assist

- Set the flash mode, self-timer/remote control, focus mode and exposure compensation before releasing the shutter for the first picture. The settings cannot be changed after shooting the first picture. Pictures cannot be deleted, nor can zoom, **Image quality** (168), or **Image size** (170) be adjusted after shooting the first picture.
- The panorama series is terminated if the auto off function (181) triggers the standby mode during shooting. To prevent this, setting a longer time for the auto off function is recommended.

## **🔦** AE/AF-L (exposure lock) Indicator

When using panorama assist mode, all pictures in the panorama have the same exposure, white balance, and focus as the first picture of the panorama.

When the first picture is shot, **AE/AF-L** is displayed to indicate that exposure, white balance, and focus are locked.

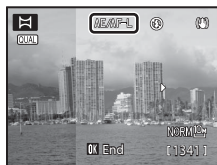

## **🔦** Panorama Maker 5

Install Panorama Maker 5 on a computer using the supplied ViewNX 2 CD-ROM.

Transfer pictures to a computer (156) and use Panorama Maker 5 (160) to join them in a single panorama.

## **🔦** More Information

See "File and Folder Names" (203) for more information.

## Shooting Low-lit Scenes (Low Noise Night Mode)

The ISO sensitivity is controlled automatically to a high level. This allows you to capture the atmosphere of a low-lit scene and shoot pictures with a low amount of noise without using the flash. It also reduces the effects of camera shake and subject movement when shooting at the telephoto zoom position.

- The available image size is **2048×1536** or smaller.
- The ISO sensitivity is set automatically within the range of ISO 400 to 12800.

### 1 Rotate the mode dial to (low noise night).

- The camera enters low noise night mode.

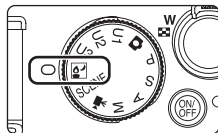

### 2 Frame the subject and take the picture.

- In the default setting, the camera automatically selects one or more of the nine focus areas containing the subject closest to the camera. When the subject is in focus, the focus area (active focus area) lights in green (maximum of nine areas) (84).
- To use the flash, raise the built-in flash.

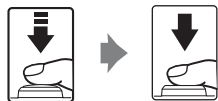

### Functions Available in Low Noise Night Mode

- The flash mode (32) can be changed, and the self-timer (35), focus mode (40), AF area mode (84) and exposure compensation (43) can be adjusted.
- Rotate the quick menu dial to **QUAL** or **WB** and press the quick menu button to select the following settings.
  - **QUAL: Image quality** (68) and **Image size** (70)  
NRW (RAW) pictures cannot be recorded. Only the following image sizes are available:  
**2048×1536** (default setting), **1600×1200**, **1280×960**, **1024×768** and **640×480**.  
The settings in **Image quality** and **Image size** are not applied to other shooting modes.
  - **WB: White balance** (76)
- The functions in the low noise night menu can be set. See "Low Noise Night Menu" (59) for more information.

### Built-in ND Filter

When the subject is too bright, set **Built-in ND filter** (184) in the setup menu (167) to reduce the light and shoot.



**✓ Notes on Low Noise Night Mode**

- Although vibration is reduced even in low-lit environments, a tripod is recommended when not using a flash. Set **Vibration reduction** (📖175) to **Off** when using a tripod to stabilize the camera.
- Because the shooting is performed with ISO sensitivity set to a high level, the shot picture may be grainy.
- Because the shooting is always performed at ISO 400 or higher, the appropriate exposure may not be obtained (overexposure) in clear sunlight.
- Focusing may be difficult in extremely dark environments.
- The slowest shutter speed is restricted to 1/4 second.

**📖 More Information**

See “Autofocus” (📖29) for more information.

**Low Noise Night Menu**

In the low noise night mode, the following functions can be set when the **MENU** button (📖13) is pressed to display the  low noise night menu.

- The setting of low noise night menu is stored in the camera’s memory independently and is not applied to the settings in any other shooting mode.

**Continuous**

**Continuous** (📖99) can be set. Choose **Single** or **Continuous**.

**Flash exp. comp.**

**Flash exp. comp.** (📖102) can be set.

**Metering**

**Metering** (📖98) can be set.

**Displaying the Low Noise Night Menu**

Rotate the mode dial to  (low noise night) mode.

Press the **MENU** button (📖13) to display the menu, and use the rotary multi selector to change to the  tab (📖14).

- Use the rotary multi selector to select and set menu options (📖12).
- To exit the low noise night menu, press the **MENU** button.

# Setting the Exposure for Shooting (P, S, A, M Modes)

## P, S, A, M Modes

By rotating the mode dial, you can shoot pictures in the following four exposure modes: **P** (Programmed auto), **S** (Shutter-priority auto), **A** (Aperture-priority auto), and **M** (Manual). Not only you can set the shutter speed and aperture value yourself, but you can also select a variety of advanced settings, such as changing the ISO sensitivity and white balance with the quick menu dial (📖10, 67).

Mode	Description	Usage
<b>P</b> Programmed auto (📖62)	The camera sets the shutter speed and aperture value automatically for optimal exposure. Flexible program, which changes the combination of shutter speed and aperture value, can be used (📖62).	Recommended for most situations.
<b>S</b> Shutter-priority auto (📖63)	The user chooses the shutter speed; the camera selects the aperture value automatically.	Use to shoot fast moving subjects using a fast shutter speed, or use to emphasize the movements of a moving subject using a slow shutter speed.
<b>A</b> Aperture-priority auto (📖64)	The user chooses the aperture value; the camera selects the shutter speed automatically.	Use to blur the background or bring both the foreground and background into focus.
<b>M</b> Manual (📖65)	The user controls both the shutter speed and aperture value.	Use to control the exposure according to shooting requirements.

Even when the mode dial is set to **U1**, **U2** or **U3** (user setting mode), you can shoot in **P** (Programmed auto), **S** (Shutter-priority auto), **A** (Aperture-priority auto) or **M** (Manual). The setting combinations (user settings) that are frequently used for shooting can be saved in **U1**, **U2** and **U3** (📖112).

### Functions Available in P, S, A and M Modes

- The flash mode (📖32) can be changed, and the self-timer (📖35), focus mode (📖40), AF area mode (📖84) and exposure compensation (📖43) settings can be adjusted.
- Rotate the quick menu dial and press the quick menu button to set the quick menu (📖10, 67).
- Press the **MENU** button to adjust the shooting menu (📖90) settings.

### Built-in ND Filter

When the subject is too bright, set **Built-in ND filter** (📖184) in the setup menu (📖167) to reduce the light and shoot.

## Shutter Speed and Aperture Value

The same exposure can be achieved with different combinations of shutter speed and aperture value, allowing you to freeze or blur motion and control depth of field. The following figure shows how shutter speed and aperture value affect exposure. When the ISO sensitivity setting ( 74) is changed, the range of shutter speeds and aperture values at which the correct exposure can be obtained also changes.

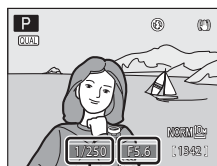

Shutter speed      Aperture value

## Adjusting the Shutter Speed



Faster  
1/1000 s



Slower  
1/30 s

## Adjusting the Aperture Value



Larger aperture  
(Small f-number)  
f/2.8



Smaller aperture  
(Large f-number)  
f/8

## P (Programmed Auto) Mode

The camera sets the shutter speed and aperture value automatically for optimal exposure.

### 1 Rotate the mode dial to P.

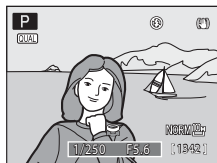

### 2 Frame the subject and shoot.

- In the default setting, the camera automatically selects one or more of the nine focus areas containing the subject closest to the camera. When the subject is in focus, the focus area (active focus area) lights in green (maximum of nine areas) (184).



### Flexible Program

In mode P (Programmed auto), different combinations of shutter speed and aperture value can be selected by rotating the command dial without changing the exposure (“flexible program”). While flexible program is in effect, a flexible program mark (X) appears next to the mode indicator (P) in the upper left of the monitor.

- Rotate the command dial to the right for large apertures (small f-numbers) when you want to blur background details, or for fast shutter speeds to capture fast-moving subjects.
- Rotate the command dial to the left for small apertures (large f-numbers) when you want to increase depth of field, or for slow shutter speeds to emphasize the motion of a subject.
- To cancel flexible program, rotate the command dial until the flexible program mark (X) is no longer displayed. Selecting another mode, or turning off the camera, also cancels flexible program.

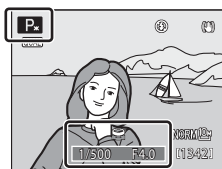
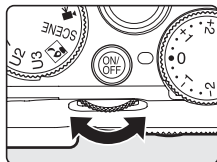

### Notes on P (Programmed Auto) Shooting

When the subject is too dark or too bright, it may not be possible to obtain the appropriate exposure. In such cases, the shutter speed indicator and aperture value indicator blink when the shutter-release button is pressed halfway. It may be possible to obtain the appropriate exposure by changing settings such as the built-in ND filter (184) and ISO sensitivity (174).

### Shutter Speed

The shutter speed may be restricted by other settings. See “Functions that Cannot be Applied Simultaneously” (108) for more information.

## S (Shutter-Priority Auto) Mode

The user chooses the shutter speed; the camera selects the aperture value automatically.

- The shutter speed can be set in a range from a maximum speed of 1/2000 to eight seconds.

### 1 Rotate the mode dial to S.

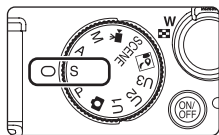

### 2 Rotate the command dial to choose a shutter speed value.

- When the Av/Tv button is pressed, the shutter speed can be set by rotating the rotary multi selector (default setting, [book 187](#)).

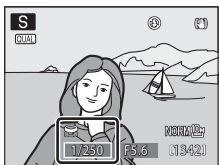

### 3 Focus and shoot.

- In the default setting, the camera automatically selects one or more of the nine focus areas containing the subject closest to the camera. When the subject is in focus, the focus area (active focus area) lights in green (maximum of nine areas) ([book 84](#)).

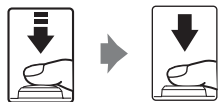

## ✓ S (Shutter-Priority Auto) Mode

- When the subject is too dark or too bright, it may not be possible to obtain the appropriate exposure with the set shutter speed. In such cases, the shutter speed indicator blinks when the shutter-release button is pressed halfway. Choose another shutter speed and try again.
- At shutter speeds of 1/4 second or slower, "noise" may appear in the image in the form of randomly spaced, brightly colored dots. In such situations, the shutter speed indicator turns red. Setting **Long exposure NR** ([book 103](#)) to **On** is recommended.

## ✎ Shutter Speed

The shutter speed may be restricted by other settings. See "Functions that Cannot be Applied Simultaneously" ([book 108](#)) for more information.

## A (Aperture-Priority Auto) Mode

The user chooses the aperture value; the camera selects the shutter speed automatically.

### 1 Rotate the mode dial to A.

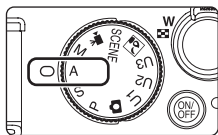

### 2 Rotate the rotary multi selector to choose the aperture value (f/-number).

- The aperture value can be set in a range of f/2.8 to 8 (wide-angle side) and f/5.6 to 8 (telephoto side).
- When the Av/Tv button is pressed, the aperture value can be set by rotating the command dial (default setting, [book 187](#)).

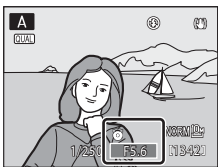

### 3 Focus and shoot.

- In the default setting, the camera automatically selects one or more of the nine focus areas containing the subject closest to the camera. When the subject is in focus, the focus area (active focus area) lights in green (maximum of nine areas) ([book 84](#)).

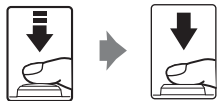

## ✓ A (Aperture-Priority Auto) Mode

When the subject is too dark or too bright, it may not be possible to obtain the appropriate exposure with the set aperture value. In such cases, the aperture value indicator blinks when the shutter-release button is pressed halfway. Choose another aperture value and try again.

### ✎ Shutter Speed

- When the zoom is on the wide-angle side and the aperture value is set to f/8 (minimum aperture), the shutter speed can be set to up to 1/4000 second.
- The shutter speed may be restricted by other settings. See “Functions that Cannot be Applied Simultaneously” ([book 108](#)) for more information.

### 📷 Aperture and Zoom

The aperture value (f-number) indicates the lens brightness. Large apertures (expressed by small f-numbers) let more light into the camera, and small apertures (large f-numbers) let less light. When the camera is zoomed in, the lens aperture can be changed within a range of f/2.8 to 5.6. The aperture value increases (becomes darker) when zooming to the telephoto side, and decreases (becomes brighter) when zooming to the wide-angle side.

## M (Manual) Mode

The user controls both the shutter speed and aperture value.

- The shutter speed can be set in a range from a maximum speed of 1/4000 to 60 seconds.

### 1 Rotate the mode dial to M.

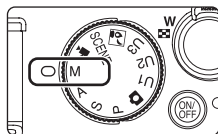

### 2 Rotate the command dial to choose a shutter speed value.

- At shutter speeds of 1/4 second or slower, the shutter speed indicator turns red (63).
- When adjusting the aperture value or shutter speed, the degree of deviation from the exposure value measured by the camera is displayed in the exposure indicator.
- The degree of deviation in the exposure indicator is shown in EVs (-3 to +3 EV in increments of 1/3 EV).

The display on the right shows that the picture will be overexposed by 1 EV (+1).

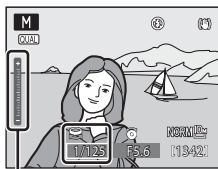

Exposure indicator

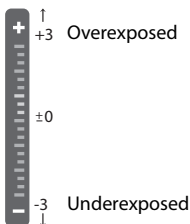

### 3 Rotate the rotary multi selector to choose an aperture value.

- Repeat steps 2 to 3 to modify shutter speed and aperture value settings until the desired exposure is achieved.

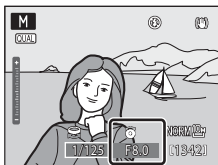

## 4 Focus and shoot.

- In the default setting, the camera automatically selects one or more of the nine focus areas containing the subject closest to the camera. When the subject is in focus, the focus area (active focus area) lights in green (maximum of nine areas) (184).

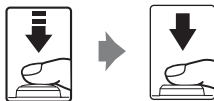

### ✔ Note on ISO Sensitivity

When **ISO sensitivity** (174) is set to **Auto** (default setting), **High ISO sensitivity auto**, **ISO 100-200** or **ISO 100-400**, ISO sensitivity is fixed at ISO 100.

### ✎ Shutter Speed

- A shutter speed of 1/4000 second is available only when the zoom is on the wide-angle side and the aperture value is set to f/8 (minimum aperture).
- The shutter speed may be restricted by other settings. See "Functions that Cannot be Applied Simultaneously" (108) for more information.

### ✎ Shutter Speed and Aperture Value Setting Methods

When the Av/Tv button is pressed, the aperture value can be set with the command dial, and the shutter speed can be set by rotating the rotary multi selector (default setting, 187). Press the Av/Tv button again to return to the originally assigned functions of the command dial and the rotary multi selector.

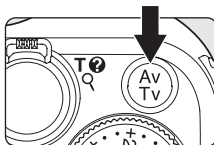



## Changing the Frequently Used Settings for Shooting (P, S, A, M Modes)

While shooting in **P, S, A, M, U1, U2** and **U3**, you can set the following options.

- Quick menu
- AF area mode (📖84)
- Shooting menu (📖90)

### Quick Menu

The following functions can be set with the quick menu dial and the quick menu button.

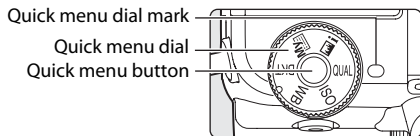

Dial position	Function		P, S, A, M, U1, U2, U3	SCENE			
QUAL	Image quality/Image size	✓	✓	✓	✓	-	68
	Movie options	-	-	-	-	✓	148
ISO	ISO sensitivity	-	✓	-	-	-	74
WB	White balance	-	✓	-	✓	✓	76
BKT	Auto bracketing	-	✓	-	-	-	80
	My Menu*	-	✓	-	-	-	187
	Tone level information	-	✓	-	-	-	82

- To use the quick menu, rotate the quick menu dial to align the mark with the function that you want to set.
- When the quick menu button is pressed while shooting, the quick menu dial mark turns on and the quick menu is displayed for the function that is selected with the mark.
- Use the rotary multi selector to set the various menu items. They can also be set using the command dial and the Av/Tv button.
- To exit the quick menu, press the quick menu button or the shutter-release button.

#### \* (My Menu)

Rotate the quick menu dial to (My Menu) and press the quick menu button to display only the menu items that are frequently used for shooting.

- Options that are displayed in My Menu can be changed from **Customize My Menu** (📖187) in the setup menu (📖167).

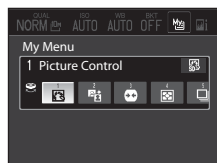

## QUAL Choosing the Image Quality and the Image Size

You can set the image quality (compression ratio) and image size to be recorded.

### Image Quality

See “Setting the Image Quality and the Image Size” (📖 73) for more information.

Choose the compression ratio applied to pictures.

Lower compression ratios result in higher quality pictures, but also larger file sizes, limiting the number of pictures that can be recorded.

#### FINE Fine

Higher quality images than **Normal**, suitable for enlargement or high quality prints.  
File format: JPEG, compression ratio of 1:4

#### NORM Normal (default setting)

Normal image quality, suitable for most applications.  
File format: JPEG, compression ratio of 1:8

#### BASIC Basic

Basic image quality is lower than with **Normal**, suitable for pictures attached to e-mails or used on web pages.  
File format: JPEG, compression ratio of 1:16

#### NRW+ FINE NRW (RAW) + Fine\*

Two images are recorded at the same time: one NRW (RAW) image and one fine-quality JPEG image.

#### NRW+ NORM NRW (RAW) + Normal\*

Two images are recorded at the same time: one NRW (RAW) image and one normal-quality JPEG image.

#### NRW+ BASIC NRW (RAW) + Basic\*

Two images are recorded at the same time: one NRW (RAW) image and one basic-quality JPEG image.

#### NRW NRW (RAW)\*

Raw data from the image sensor are saved. Create JPEG image files after shooting using **NRW (RAW) processing** (📖 143) in the playback menu.

- When **NRW (RAW)** is selected, **Image size** is reset to 📏 **3648x2736**.
- White balance and COOLPIX Picture Control settings can be adjusted in **NRW (RAW) processing**.
- NRW (RAW) images cannot be printed. Creating JPEG images with **NRW (RAW) processing** enables the images to be printed using PictBridge compatible printers or in digital photo labs.

File format: NRW (RAW)

\* NRW (RAW) images cannot be chosen in scene mode or low noise night mode.

### **COOLPIX P7000 NRW (RAW) images**

- The extension of the image taken is "NRW."
- No editing other than NRW (RAW) processing can be performed for pictures in the NRW (RAW) format. To edit such pictures, first create JPEG pictures using **NRW (RAW) processing** (☞143), and then edit the JPEG pictures.
- ViewNX 2 needs to be installed on the computer to be able to view NRW (RAW) images on the computer. Capture NX 2 is also compatible with NRW (RAW) images.
- Install ViewNX 2 on a computer using the supplied ViewNX 2 CD-ROM. (See "Installing ViewNX 2" of the *Quick Start Guide*.)

For more information on using ViewNX 2, refer to the on-screen instructions and help information contained in ViewNX 2.

### **Notes on Image Quality Setting**

- The setting for image quality is shown by an icon displayed on the monitor during shooting and playback (☞6, 8).
- Can be set from the quick menu dial even in shooting modes other than **P, S, A** and **M** (except for movie mode).
- The setting is also applied to other shooting modes (except for shooting modes **U1, U2** and **U3**).
- NRW (RAW) images cannot be recorded in scene mode or low noise night mode. When the image quality is set to **NRW (RAW)** and the scene mode is selected, the image quality is changed to **Normal**. When the image quality is set to **NRW (RAW) + Fine**, **NRW (RAW) + Normal** or **NRW (RAW) + Basic** and the scene mode is selected, the image quality for each is changed to **Fine**, **Normal** or **Basic**.
- The digital zoom cannot be used when **Image quality** is set to **NRW (RAW)**, **NRW (RAW) + Fine**, **NRW (RAW) + Normal** or **NRW (RAW) + Basic**.
- This feature cannot be used simultaneously with certain features. See "Functions that Cannot be Applied Simultaneously" (☞108) for more information.

### **Recording of NRW (RAW) and JPEG images at the same time**

- The NRW (RAW) image and the JPEG image that are recorded at the same time have the same file number but their own file extensions, ".NRW" and ".JPG" (☞203).
- When playing back on the camera, only the JPEG image is displayed.
- Note that when the JPEG image is deleted by pressing the  button, the NRW (RAW) image that was recorded at the same time is also deleted.

### **More Information**

- See "Number of Exposures Remaining" (☞71) for more information.
- See "File and Folder Names" (☞203) for more information.

## Image Size

See “Setting the Image Quality and the Image Size” (📖 73) for more information.

You can set the JPEG image size (amount of pixels) for pictures recorded with an image quality of **Fine**, **Normal** or **Basic**.

The larger the image, the larger the size at which it can be printed or displayed without becoming noticeably “grainy,” limiting the number of pictures that can be recorded.

Conversely, small image sizes are suitable for pictures attached to e-mails or used on web pages. However, printing small images in large print sizes results in the image turning “grainy.”

Image size	Description
3648×2736 (default setting)	Record pictures with finer detail than those shot at  3264×2448 or  2592×1944.
3264×2448	Smaller than  3648×2736,  3264×2448 and  2592×1944; for recording more pictures.
2592×1944	
2048×1536	
1600×1200	
1280×960	
1024×768	Record pictures of a size suitable for display on devices such as a computer monitor.
640×480	Record pictures suitable for display on a television with a screen aspect ratio of 4:3, or for e-mail attachment.
3648×2432	Record pictures with the same aspect ratio (3:2) as those shot with 35mm [135] format film cameras.
3584×2016	Record pictures with the same aspect ratio (16:9) as wide-screen televisions.
2736×2736	Record square pictures.











The setting for the image size is shown by an icon displayed on the monitor during shooting and playback (📖 6 to 8).

### Notes on Image Size Setting

- Can be set from the quick menu dial even in shooting modes other than **P**, **S**, **A** and **M** (except for movie mode).
- The setting is also applied to other shooting modes (except for low noise night mode, and shooting modes **U1**, **U2** and **U3**).
- In low noise night mode, the available image size is 2048×1536 or smaller.
- The size of JPEG images can be chosen when you create JPEG images from NRW (RAW) images using **NRW (RAW) processing** (📖 143) (up to a maximum of 3648×2736 pixels).
- **Image size** for the JPEG image can be set when **NRW (RAW) + Fine**, **NRW (RAW) + Normal** or **NRW (RAW) + Basic** is selected. However, note that 3648×2432, 3584×2016 and 2736×2736 cannot be selected.
- This feature cannot be used simultaneously with certain features. See “Functions that Cannot be Applied Simultaneously” (📖 108) for more information.

## Number of Exposures Remaining

The following table lists the approximate number of pictures that can be stored in the internal memory and on a 4 GB memory card, at each combination of **Image size** (□□70) and **Image quality** (□□68) settings. Note that the number of images that can be stored differs depending on the composition of the image (due to JPEG compression). In addition, this number may differ depending on the make of memory card, even if the capacity of the memory card is the same.

Image size	Image quality	Internal memory (79 MB)	Memory card <sup>1</sup> (4 GB)	Print size <sup>2</sup> (cm/in.)
 3648×2736 (default setting)	Fine	16	770	31×23/12×9 <sup>3</sup>
	Normal	32	1,540	
	Basic	63	3,010	
	NRW (RAW)	5	230	
 3264×2448	Fine	20	970	28×21/11×8
	Normal	40	1,910	
	Basic	78	3,650	
 2592×1944	Fine	32	1,520	22×16/8.5×6.5
	Normal	62	2,940	
	Basic	117	5,480	
 2048×1536	Fine	50	2,410	17×13/7×5
	Normal	97	4,640	
	Basic	181	8,620	
 1600×1200	Fine	80	3,770	14×10/5×4
	Normal	153	7,100	
	Basic	266	12,000	
 1280×960	Fine	120	5,740	11×8/4×3
	Normal	220	10,000	
	Basic	362	17,200	
 1024×768	Fine	181	8,620	9×7/3.5×2.5
	Normal	316	15,000	
	Basic	507	24,100	
 640×480	Fine	362	17,200	5×4/2×1.5
	Normal	563	24,100	
	Basic	724	30,100	
 3648×2432	Fine	18	870	31×21/12×8
	Normal	36	1,720	
	Basic	70	3,350	
 3584×2016	Fine	22	1,060	30×17/12×6.5
	Normal	44	2,110	
	Basic	85	4,020	
 2736×2736	Fine	21	1,030	23×23/9×9
	Normal	42	2,040	
	Basic	83	3,890	

## Changing the Frequently Used Settings for Shooting (P, S, A, M Modes)

- 1 If the number of exposures remaining is 10,000 or more, "9999" is displayed.
- 2 The print size at an output resolution of 300 dpi.  
Print sizes are calculated by dividing the number of pixels by the printer resolution (dpi) and multiplying by 2.54 cm (1 in.). However, even with the same image size setting, images printed at higher resolutions print smaller than the size indicated, and those printed at lower resolutions print larger than the size indicated.
- 3 The print size of NRW (RAW) images differs according to the image size of the NRW (RAW) processed images (📖143).



### Printing Images of Size 1:1

Change the printer setting to "Border" when printing images with the size set to 1:1.

The images may not be printed in 1:1 ratio depending on the printer.

See the instruction manual of the printer or check with the authorized print dealer for further details.

## Setting the Image Quality and the Image Size

**1** Rotate the quick menu dial to **QUAL** and press the quick menu button.

- The quick menu is displayed.
- Rotate the mode dial (📖44) to a setting other than **M**.

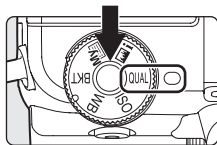

**2** Choose the type of Image quality (📖68) with the rotary multi selector.

- Items can also be chosen by rotating the command dial.
- To change the image quality only, choose the type of image quality, and then press the quick menu button.
- To continue and change the image size, press the rotary multi selector ▼. The Av/Tv button can also be used to proceed to the next step.

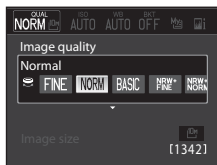

**3** Choose the type of Image size (📖70).

- **Image size** cannot be selected when **NRW (RAW)** is selected for **Image quality**.
- The number of exposures remaining for the selected Image size is displayed.
- Press the rotary multi selector ▲ to return to the Image quality setting.

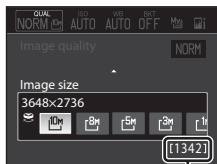

Numbers of exposures remaining

**4** After completing the settings, press the quick menu button or the **OK** button.

- The monitor display reverts to shooting mode.

## ISO Setting the ISO Sensitivity

See “Setting the ISO Sensitivity” (📖 75) for more information.

Setting the ISO sensitivity to a high level enables shooting when the light intensity is low. The higher the ISO sensitivity, the darker the subject that can be shot. Also, using a faster shutter speed for a subject of the same brightness makes it easier to reduce blur caused by camera vibration or subject movement.

- Setting the ISO sensitivity to a high level is effective when shooting dark subjects, not using the flash, shooting at the telephoto zoom position and similar situations, but the pictures may be slightly grainy.

### ISO sensitivity

- **AUTO Auto** (default setting): The sensitivity is ISO 100 in bright places; in dark places the camera automatically raises the sensitivity to a maximum of ISO 800.
- **ISO High ISO sensitivity auto**: The ISO sensitivity is set automatically within the range of ISO 100 to 1600 according to the brightness of the subject.
- **ISO 100-200**, **ISO 100-400** (fixed range auto): Choose the range in which the camera automatically adjusts ISO sensitivity. The camera does not raise sensitivity beyond the maximum value in the selected range. Set the maximum value for ISO sensitivity to control “grain” that appears in images.
- **100, 200, 400, 800, 1600, 3200, Hi 1** (equivalent to ISO 6400): ISO sensitivity is locked at the specified value.

### Minimum shutter speed

When the shooting mode is **P** or **A** and **ISO sensitivity** is set to **Auto**, **High ISO sensitivity auto**, **ISO 100-200** or **ISO 100-400**, the shutter speed at which the ISO sensitivity automatic control starts to function (1/125 to one second) is set. The default setting is **None**. If the exposure is insufficient with the shutter speed that is set here, the ISO sensitivity is increased automatically to obtain the correct exposure. If the exposure is still insufficient even after the ISO sensitivity is increased, the shutter speed slows down.

The icon for the current setting is displayed on the monitor (📖 6).

- If **Auto** is selected and the sensitivity is automatically raised above ISO 100, the **ISO** icon is displayed (📖 34).
- When **High ISO sensitivity auto** is selected, the **ISO** icon is displayed. When **ISO 100-200** or **ISO 100-400** is selected, the **ISO** icon and the maximum ISO sensitivity value are displayed.

### 📌 Notes on ISO Sensitivity

- In **M** (manual) mode, ISO sensitivity is fixed at ISO 100 if **Auto**, **High ISO sensitivity auto**, **ISO 100-200** or **ISO 100-400** is selected.
- When the ISO sensitivity is set to a high level, the shutter speed may be restricted. See “Functions that Cannot be Applied Simultaneously” (📖 108) for more information.
- This feature cannot be used simultaneously with certain features. See “Functions that Cannot be Applied Simultaneously” (📖 108) for more information.



## Setting the ISO Sensitivity

**1** Rotate the quick menu dial to ISO and press the quick menu button.

- The quick menu is displayed.

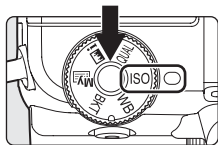

**2** Choose the ISO sensitivity with the rotary multi selector.

- Items can also be chosen by rotating the command dial.
- Press the rotary multi selector ▼ when the ISO sensitivity is set to **Auto**, **High ISO sensitivity auto**, **ISO 100-200** or **ISO 100-400** to proceed to step 3. The Av/Tv button can also be used to proceed to the next step.
- If the ISO sensitivity is fixed, proceed to step 4.

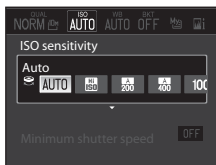

**3** Choose the minimum shutter speed.

- Press the rotary multi selector ▲ to return to the ISO sensitivity setting.

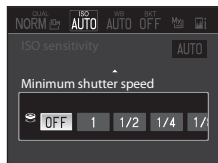

**4** After completing the settings, press the quick menu button or the **OK** button.

- The monitor display reverts to shooting mode.

## WB Matching Image Colors with Colors as Seen with the Naked Eye (White Balance)

See “Setting the White Balance” (📖77) for more information.

The color of light reflected from an object varies with the color of the light source. The human brain is able to adapt to changes in the color of the light source, with the result that white objects appear white whether seen in the shade, direct sunlight, or under incandescent lighting. Digital cameras can mimic this adjustment of the human eye by processing images according to the color of the light source. This is known as “white balance.”

For natural coloration, choose a white balance setting that matches the light source before shooting.

Although the default setting, **Auto**, can be used under most types of lighting, you can apply the white balance setting suited to a particular light source to achieve more accurate results.

- Available when the shooting mode is **P, S, A, M, U1, U2, U3**, 📷 (low noise night) or movie mode.

### **AUTO** Auto (default setting)

The white balance is automatically adjusted to suit the lighting conditions. The best choice in most situations.

### Daylight

The white balance is adjusted for direct sunlight.

### Incandescent

Use under incandescent lighting.

### Fluorescent (FL1 to FL3)

Use under most types of fluorescent lighting. Choose one of **FL1** (white fluorescent), **FL2** (daylight white/neutral fluorescent) and **FL3** (daylight fluorescent).

### Cloudy

Use when shooting under overcast skies.

### Flash

Use with the flash.

### Choose color temp.

Use to directly specify the color temperature (📖78).

### **PRE** Preset manual (1 to 3)

A neutral-colored object is used as a reference to set the white balance under unusual lighting conditions. See “Preset Manual” (📖79) for more information.

The effects of the selected option can be previewed on the monitor (📖6). At settings other than **Auto**, the icon for the current setting is displayed on the monitor.

### Notes on White Balance

- At white balance settings other than **Auto** or **Flash**, set the flash to  (Off) (📖32).
- This feature cannot be used simultaneously with certain features. See “Functions that Cannot be Applied Simultaneously” (📖108) for more information.

## Setting the White Balance

**1** Rotate the quick menu dial to **WB** and press the quick menu button.

- The quick menu is displayed.

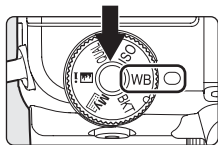

**2** Choose the type of white balance with the rotary multi selector and press **▼**.

- Items can also be chosen by rotating the command dial.
- When **Choose color temp.** is chosen, set the color temperature (78).
- The Av/Tv button can also be used to proceed to the next step.



**3** Perform fine adjustment of the setting by pressing **▲**, **▼**, **◀** or **▶**.

- The four directions are A (amber), B (blue), G (green) and M (magenta), and fine adjustment can be performed in six levels in all directions.
- When the button is pressed, the fine adjustment value is reset to the center (coordinate 0, 0).
- Press the Av/Tv button to return to the screen in the previous step.

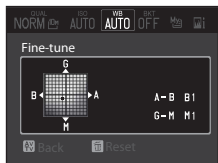

**4** After completing the settings, press the quick menu button or the **OK** button.

- The monitor display reverts to shooting mode.

### Fine Adjustment of White Balance

The color displayed in the fine-tune screen for white balance represents the approximate color in the color temperature direction. When a color is set in the fine-tune screen, it may not be reproduced exactly in the image. For example, when the white balance is set to **Incandescent**, the image will not have a strong blue color even if fine adjustment is performed in the B (blue) direction.

## Changing the Frequently Used Settings for Shooting (P, S, A, M Modes)

### Color Temperature

The perceived color of a light source varies with the viewer and other conditions. Color temperature is an objective measure of the color of a light source, defined with reference to the temperature to which an object would have to be heated to radiate light in the same wavelengths. While light sources with a color temperature in the neighborhood of 5000–5500K appear white, light sources with a lower color temperature, such as incandescent light bulbs, appear slightly yellow or red. Light sources with a higher color temperature appear tinged with blue. The camera white balance options are adapted to the following color temperatures.

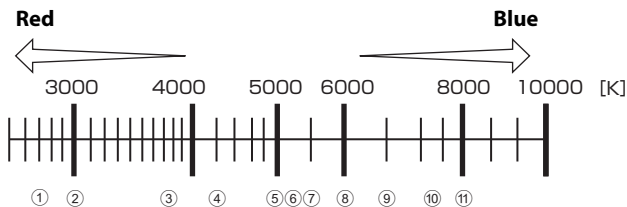

More on Shooting

- |  |                                   |
|--|-----------------------------------|
| ① Sodium-vapor lamps: 2700K                      | ⑦ Flash: 5400K                    |
| ② Incandescent/<br>Warm-white fluorescent: 3000K | ⑧ Cloudy: 6000K                   |
| ③ White fluorescent: 3700K                       | ⑨ Daylight fluorescent: 6500K     |
| ④ Cool-white fluorescent: 4200K                  | ⑩ High temp. mercury-vapor: 7200K |
| ⑤ Day white fluorescent: 5000K                   | ⑪ Shade: 8000K                    |
| ⑥ Direct sunlight: 5200K                         |                                   |

## Preset Manual

Use when you want to make pictures shot under unusual lighting conditions (such as lamps with reddish light) look as though they were shot in normal light.

Use the procedure below to shoot after measuring the white balance value under the shooting light.

- Up to three preset values can be saved: PRE1, PRE2 and PRE3.

**1** Place a white or gray reference object under the lighting that will be used during shooting.

**2** Display the white balance quick menu (☰76), choose PRE1, PRE2 or PRE3 with the rotary multi selector, and press ▼.

- Items can also be chosen by rotating the command dial.
- The lens extends to the zoom position for measurement.
- The Av/Tv button can also be used to proceed to the next step.

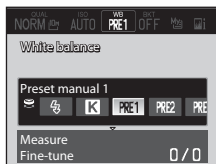

**3** Frame a white or gray reference object in the reference object frame.

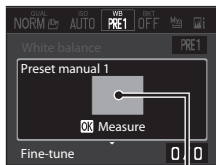

Reference object frame

**4** Press the **OK** button to measure the white balance value.

- The shutter is released and the new white-balance preset value is set (no picture is recorded).

### ✔ Note on Preset Manual

- The camera cannot measure a white balance value for when the flash fires. When shooting with the flash, set **White balance** to **Auto** or **Flash**.
- When a wide-angle converter is mounted, preset manual cannot be used. Further, the preset value cannot be measured.

### 📎 Using the Previously Measured White Balance Value

Press the quick menu button or the shutter-release button in step 3. The most recently measured value is set for white balance, without performing measurement again.

### 📎 Performing Fine Adjustment for the Measured White Balance Value

After measuring, display the screen in step 3 again and press the ▼ button to perform fine adjustment for white balance (step 3 of ☰77).

## BKT Continuous Shooting while Changing the Shutter Speed, ISO Sensitivity and White Balance (Bracketing)

See “Setting the Bracketing” (📖81) for more information.

Continuous shooting can be performed while changing the exposure (brightness) automatically with the shutter speed (Tv) or ISO sensitivity (Sv), or multiple pictures can be recorded while varying the white balance (WB). This is effective when adjusting the brightness of an image is difficult, or when multiple light sources are mixed together and it is difficult to decide the white balance.

### OFF Off (default setting)

Bracketing is not performed.

### **Tv** Exposure bracketing (Tv)

Set the number of pictures to shoot continuously, the number of exposure increments, and the bracketing range. When the shutter-release button is fully pressed, pictures are shot continuously while the shutter speed is adjusted automatically.

- “Tv” means “Time value.”

### **Sv** Exposure bracketing (Sv)

Set the number of pictures to shoot continuously, the number of ISO sensitivity increments, and the bracketing range. When the shutter-release button is pressed fully, pictures are shot continuously while changing the ISO sensitivity, with the shutter speed and aperture value fixed.

- “Sv” means “Sensitivity value.”

### **WB** White balance bracketing

Set the number of pictures to record, the number of color temperature compensation increments, and the bracketing range. When the shutter-release button is pressed fully, one picture is shot, and the set number of pictures is recorded with the color temperature changed for each one.

When bracketing is enabled, the current setting is displayed during shooting (📖6). When **Off** is selected, an icon for the current setting is not displayed.

### ✔ Notes on Bracketing

- **Exposure bracketing (Tv)** and **Exposure bracketing (Sv)** are not available in **M** (manual) mode.
- **Exposure bracketing (Tv)** is not available in **S** (Shutter-priority auto) mode.
- When exposure compensation (📖43) and **Exposure bracketing (Tv)** are set simultaneously, the combined exposure compensation is applied.
- In **White balance bracketing**, only compensation for the color temperature (horizontal direction from A (amber) to B (blue)) is performed. Compensation in the vertical direction from G (green) to M (magenta) is not performed.
- This feature cannot be used simultaneously with certain features. See “Functions that Cannot be Applied Simultaneously” (📖108) for more information.

## Setting the Bracketing

- 1 Rotate the quick menu dial to BKT and press the quick menu button.

- The quick menu is displayed.

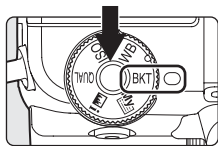

- 2 Choose the type of bracketing with the rotary multi selector and press ▼.

- Items can also be chosen by rotating the command dial.
- The Av/Tv button can also be used to proceed to the next step.

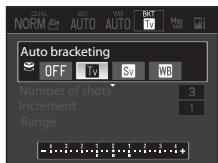

- 3 Choose the number of pictures to shoot and press ▼.

- 3 or 5 pictures can be chosen.

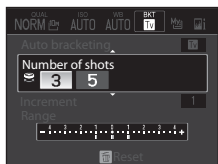

- 4 Choose the compensation step and press ▼.

- For **Exposure bracketing (Tv)** or **Exposure bracketing (Sv)**, choose **0.3**, **0.7** or **1**.
- For **White balance bracketing**, choose **1**, **2** or **3**.

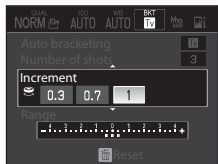

- 5 Choose the bracketing range and press the quick menu button or the OK button.

- The monitor display reverts to shooting mode.
- When the button is pressed, the settings are reset and the monitor returns to step 3.

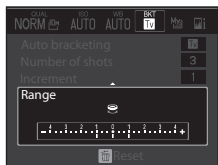

# Checking the Picture Brightness Distribution (P, S, A, M Modes)

“Tone level information” is displayed automatically each time the shutter is released so that you can check the brightness distribution of the shot picture and the shooting information.

You can check for loss of contrast detail in highlights and shadows from the histogram that is displayed, or the blinking display for each tone level. These provide guidelines when adjusting the picture brightness with functions such as exposure compensation.

- Tone level information can be used when **P, S, A, M, U1, U2** or **U3** is chosen for shooting mode. Choose the shooting mode with the mode dial (📖44).

- 1** Rotate the quick menu dial to  and press the quick menu button to turn on the quick menu dial mark.

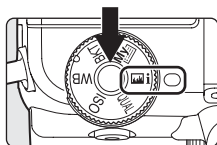

- The tone level information icon blinks on the monitor.

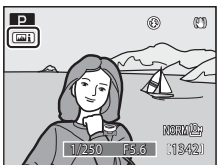

- 2** Frame the subject and shoot.

- The tone level information of the shot picture is displayed.

- 3** Check the brightness distribution and shooting information.

- Choose the tone level to check with ▲ or ▼ on the rotary multi selector. The area of the picture that corresponds to the chosen tone level blinks.
- See “Histogram and Shooting Information Displays of Tone Level Information” (📖83) for more information.
- See “Operations in the Tone Level Information Screen” (📖83) for more information.

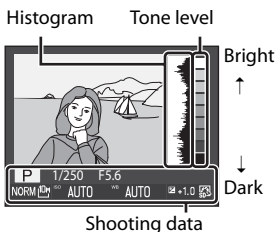

- 4** After completing your check, press the shutter-release button halfway.

- The monitor display reverts to shooting mode.
- To turn off the automatic display function of the tone level information, press the quick menu button to turn off the quick menu dial mark, or rotate the quick menu dial to a setting other than .



## Histogram and Shooting Information Displays of Tone Level Information











- The histogram is a graph that shows the brightness distribution in the picture. The horizontal axis shows the number of pixels, and the vertical axis corresponds to pixel brightness.
- The shooting information displayed includes the shooting mode used (P, S, A or M), shutter speed, aperture value, image quality, image size, ISO sensitivity, white balance, exposure compensation, and COOLPIX picture control.

## Displaying Tone Level Information in Playback Mode

The tone level information can also be displayed (14) by pressing the  button in full-frame playback mode.

## Operations in the Tone Level Information Screen

The following operations can be performed for the tone level information.

To	Use	Description	
Choose the tone level		Rotate the rotary multi selector or press ▲ or ▼.	–
Choose pictures		Press ◀ or ▶ to choose a picture to display.	12
		Rotate the command dial.	9
Playback zoom	T (Q)	Enlarge the view of the picture currently displayed on the monitor, up to about 10x. Press the  button to return to the full-frame playback mode.	118
Display menu	MENU	Display the playback menu.	123
Switch to the shooting mode		Press the shutter-release button to enter the shooting mode.	30
Exit the tone level information		When the quick menu button is pressed or the quick menu dial is rotated to a setting other than  while shooting, the automatic display function turns off.	–
		Press the  button during playback to switch the information displayed on the monitor.	14

## Selecting the Focus Area (P, S, A, M Modes)

In shooting modes **P, S, A, M, U1, U2, U3** and  (low noise night), you can change how the camera selects the focus area for autofocus.



### Face priority

The camera automatically detects and focuses on a face (see “Shooting with Face Priority” (📖86) for more information). If the camera detects multiple faces, the camera focuses on the face closest to the camera. When subjects other than people are photographed, or a subject with which no face can be detected is framed, AF area mode is set to **Auto**. The camera automatically selects one or more of the nine focus areas containing the subject closest to the camera.

- When the monitor is turned off, the focus area is fixed to the **Center (normal)**.

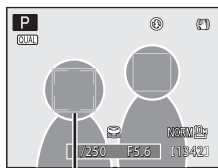

Focus area



### Auto (default setting)

The camera automatically selects one or more of the nine focus areas containing the subject closest to the camera.

Press the shutter-release button halfway to activate the focus area.

When the shutter-release button is pressed halfway, the focus area selected by the camera is displayed on the monitor (up to nine areas).

- When the monitor is turned off, the focus area is fixed to the **Center (normal)**.

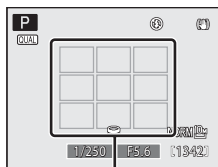

Focus areas



### Manual

Choose manually the focus position from 99 areas in the screen. This option is suited to situations in which the intended subject is relatively still and not positioned in the center of the frame.

Rotate the rotary multi selector or press **▲**, **▼**, **◀** or **▶** to select one of 99 focus areas displayed on the monitor's focus-area selection screen, and shoot.

To end focus-area selection and adjust the flash mode, focus mode and self-timer settings, press the **OK** button. To return to the focus-area selection screen, press the **OK** button again.

- At an **Image size** setting (📖70) of  **2736x2736**, 81 focus areas are available.

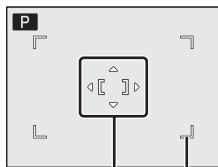

Focus area  
Selectable areas

### [ ] Center (wide), Center (normal), Center (spot)

The camera focuses on the subject in the center of the frame. The center focus area is displayed all the time. Three sizes are available for the focus area.

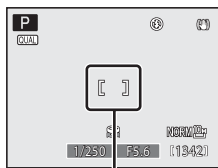

Focus area

### [+] Subject tracking

Subject tracking begins once you select a subject to be focused on, and the focus area will move and follow the subject. See "Focusing on Moving Subjects for Shooting (Subject Tracking)" (188).

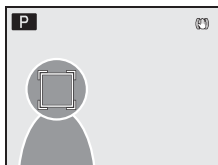

## Using AF Area Mode

### 1 Press [H] (AF area mode) on the rotary multi selector.

- The AF area mode menu is displayed.



### 2 Rotate the rotary multi selector to choose the desired focus area and press the [OK] button.

- When selecting [ ] (center), press ▲ or ▼ to select wide, normal or spot.
- If the [OK] button is not pressed within a few seconds, the selection is set and the setting menu disappears.

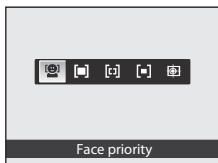

### ✓ Notes on AF Area Mode

- When the digital zoom is in effect, the camera focuses on the subject in the center focus area regardless of the applied AF area mode option.
- In some rare cases of shooting subjects for which autofocus does not perform as expected (129), the subject may not be in focus.
- This feature cannot be used simultaneously with certain features. See "Functions that Cannot be Applied Simultaneously" (108) for more information.

## Shooting with Face Priority

The camera automatically detects and focuses on a face.

The face priority function is enabled for the following situations.

- **Face priority** is selected for AF area mode (📖84)
- When **Scene auto selector** (📖46), **Portrait** (📖48) or **Night portrait** (📖49) is selected in scene mode
- When 📷 (Smile timer) is selected (📖36)

### 1 Frame the picture.

- When the camera detects a face, the focus area containing the face is displayed with a double yellow border.

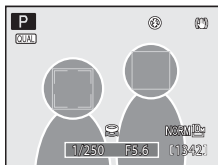

- When the camera detects more than one face, depending upon the shooting mode, the operation varies as follows.

Shooting mode	Faces framed by a double border	Number of faces to be recognized
P, S, A, M, U1, U2, U3 modes ( <b>Face priority</b> )	The face closest to the camera * The other faces are framed by a single border.	Up to 12
<b>Scene auto selector, Portrait or Night portrait</b> scene modes		
📷 ( <b>Smile timer</b> )	The face closest to the center of the frame * The other faces are framed by a single border.	Up to 3

### 2 Press the shutter-release button halfway.

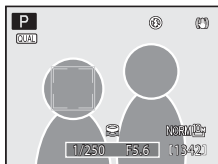

- The camera focuses on the face framed by the double border. The double border lights in green and the focus is locked.
- When the camera is unable to focus on a face, the double border blinks. Press the shutter-release button halfway again and focus.
- Press the shutter-release button all the way down to shoot.
- If the shutter-release button is fully pressed down while 📷 (Smile timer) is set, the shutter releases automatically when the camera detects a smiling face (📖36).



## ✓ Notes on Face Priority

- When **Face priority** is selected for AF area mode, the setting automatically switches to **Auto** if no face is detected when the shutter-release button is pressed halfway.
- If no face is recognized when the shutter-release button is pressed halfway in the **Portrait** or **Night portrait** scene mode, the camera focuses on the subject in the center focus area.
- The camera may not detect faces in the following situations:
  - When faces are partially hidden by sunglasses or other obstructions
  - When faces take up too much or too little of the frame
- If the camera detects more than one face, the face that it focuses on depends on the shooting conditions, such as whether or not the subject is facing the camera.
- In some rare cases of shooting subjects for which autofocus does not perform as expected (📖29), the subject may not be in focus despite the fact that the double border lights in green. If you cannot focus, change the AF area mode setting to **Manual, Center (wide), Center (normal)** or **Center (spot)**, or try shooting with focus lock (📖29) by switching the shooting mode to a mode such as auto mode and refocusing on another subject at the same distance.

## Focusing on Moving Subjects for Shooting (Subject Tracking)

To focus on moving subjects, set the autofocus area setting to  (subject tracking) in shooting mode P, S, A, M, U1, U2, U3 or  (low noise night). Subject tracking begins once you select a subject to be focused on, and the focus area will move and follow the subject.

### 1 Press (AF area mode) on the rotary multi selector.

- The AF area mode menu is displayed.

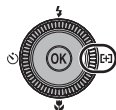

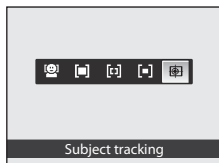

### 2 Rotate the rotary multi selector to choose (subject tracking) and press the button.

- The camera enters subject tracking, and a white border is displayed in the center of the frame.
- If the  button is not pressed within a few seconds, the selection is set and the setting menu disappears.



### 3 Select a subject.

- Frame the subject in the center of the border, and press the  button.
  - The subject is registered.
  - When the camera is unable to focus on the subject, the border lights in red. Change the composition and try again.
- Once the subject is registered, it is framed by a yellow focus area display, and subject tracking begins.
- To change subjects, press the  button to cancel the currently selected subject, then select a new subject.
- If the camera loses sight of the subject, the focus area display disappears; register the subject again.

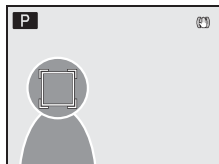
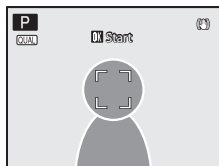

## 4 Press the shutter-release button to take the picture.

- If the camera focuses on the focus area when the shutter-release button is pressed halfway, the focus area display turns green and the focus is locked.
- If the camera is unable to focus, the focus area display will blink. Press the shutter-release button halfway again to focus.
- If the shutter-release button is pressed halfway while the focus area is not displayed, the camera focuses at the center of the frame.
- Press the shutter-release button the rest of the way down to take the picture.

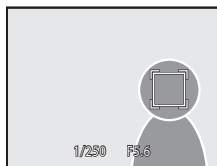

## ✓ Subject Tracking

- The digital zoom is not available.
- Set the zoom position, flash mode, focus mode, or menu before registering a subject. If any of these are changed after a subject is registered, the subject will be canceled.
- During certain conditions, such as when the subject is moving quickly, when there is a large amount of camera shake, or when there are multiple subjects that look alike, the camera may not be able to register or track a subject, or the camera may track a different subject. Additionally, the subject may not be tracked properly depending on factors such as the subject's size and brightness.
- In some rare cases of shooting subjects for which autofocus does not perform as expected (📖29), the subject may not be in focus despite the fact that the focus area lights in green. If you cannot focus, change the AF area mode setting to **Manual, Center (wide), Center (normal)** or **Center (spot)**, or try shooting with focus lock (📖29) by switching the shooting mode to a mode such as auto mode and refocusing on another subject at the same distance.
- In subject tracking, the monitor is not turned off even when the [ ] button is pressed (📖14).
- This feature cannot be used simultaneously with certain features. See "Functions that Cannot be Applied Simultaneously" (📖108) for more information.

## Shooting Options: Shooting Menu (P, S, A, M Modes)

While shooting in **P, S, A, M, U1, U2** and **U3** (📖112), the shooting menu contains the following options.

### Picture Control

📖92

Change the settings for image recording according to the shooting scene or your preferences.

### Custom Picture Control

📖96

Save adjusted COOLPIX Picture Controls as custom settings to be used for picture editing.

### Metering

📖98

Choose how the camera meters exposure.

### Continuous

📖99

Change the settings for continuous shooting and BSS (Best Shot Selector).

### Autofocus mode

📖102

Choose how the camera focuses.

### Flash exp. comp.

📖102

Adjust the flash level.

### Noise reduction filter

📖103

Set the strength of the noise reduction function that is normally performed when recording a picture.

### Long exposure NR

📖103

Reduce noise in pictures shot at slow shutter speeds.

### Distortion control

📖104

Choose whether to correct the peripheral distortion that occurs due to the intrinsic characteristics of lenses.

### Wide-angle converter

📖104

Adjust the settings for the converter lenses (available separately).

### Flash control

📖105

Control the built-in flash.

### Active D-Lighting

📖106

Prevent loss of contrast details in highlights and shadows when shooting images.

### Zoom memory

📖107

Set the focal length that is selected when the zoom control is operated while pressing the **Fn** button.



## Displaying the Shooting Menu

Choose **P** (Programmed auto), **S** (Shutter-priority auto), **A** (Aperture-priority auto), **M** (Manual), or **U1**, **U2** or **U3** (User settings) by rotating the mode dial.

Press the **MENU** button to display the shooting menu and use the rotary multi selector to change to **P**, **S**, **A** or **M** tab (📖14).

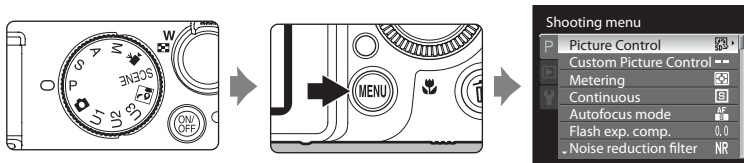

- Use the rotary multi selector to select items and set functions on menu (📖12).
- Press the **MENU** button to exit the shooting menu.

### ✓ Functions that Cannot be Applied Simultaneously

Some functions cannot be enabled in conjunction with others (📖108).

### ✎ Navigating the Camera Menu

The command dial can also be used in place of the rotary multi selector.

## Picture Control (COOLPIX Picture Control)

Set to P, S, A or M → MENU → P, S, A, M (shooting menu) (📖91) → Picture Control

Change the settings for image recording according to the shooting scene or your preferences. Sharpness, contrast and saturation can be adjusted in detail.



### Standard (default setting)

Standard processing for balanced results. Recommended for most situations.



### Neutral

Minimal processing for natural results. Choose for photographs that will later be extensively processed or retouched.



### Vivid

Pictures are enhanced for a vivid, photoprint effect. Choose for photographs that emphasize primary colors, such as blue, red, and green.



### Monochrome

Take monochrome photographs in black-and-white or sepia.



### Custom 1\*

Change to the setting for **Custom 1** in COOLPIX Custom Picture Control.



### Custom 2\*

Change to the setting for **Custom 2** in COOLPIX Custom Picture Control.

\* Only displayed when the setting customized in **Custom Picture Control** (📖96) has been registered.

The current COOLPIX Picture Control is shown in the shooting information display (nothing is displayed when **Standard** is selected) (📖6).



### COOLPIX Picture Control

- The COOLPIX Picture Control feature of the COOLPIX P7000 cannot be used with other makes of cameras, Capture NX, Capture NX 2 and ViewNX 2 Picture Control feature.
- This feature cannot be used simultaneously with certain features. See "Functions that Cannot be Applied Simultaneously" (📖108) for more information.

## Customizing Existing COOLPIX Picture Controls: Quick Adjust and Manual Adjust

COOLPIX Picture Control can be customized using Quick adjust, which allows for balanced adjustment of sharpness, contrast, saturation and other image editing components, or manual adjust, which allows for detailed adjusting of the components individually.

- 1 Use the rotary multi selector to choose COOLPIX Picture Control and press the **OK** button.

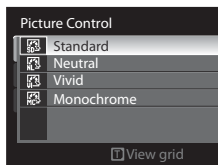

- 2 Press **▲** or **▼** to highlight the desired setting (94) and press **◀** or **▶** to choose a value.

- Press the **OK** button to set the value.
- When COOLPIX Picture Controls are modified from the default settings, an asterisk (\*) is displayed after the options in the Picture Control Setting menu.
- To change the values to the default setting, select **Reset** and press the **OK** button.

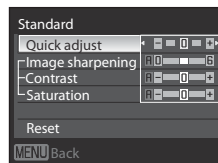

### View Grid of COOLPIX Picture Control

When the zoom control is rotated in the **T** (Q) direction while the screen in step 1 of the above procedure is displayed, the contrast and saturation are displayed using a grid. The vertical axis indicates the contrast level, and the horizontal axis indicates the saturation. Rotate the zoom control in the **T** (Q) direction again to return to the previous screen.

The COOLPIX Picture Control grid displays the current and default settings in relation to the other COOLPIX Picture Controls.

- Rotate the rotary multi selector to change to other COOLPIX Picture Controls.
- Press the **OK** button to display the COOLPIX Picture Control Setting screen (step 2 above).
- For **Monochrome**, the grid is displayed for contrast only.
- The grid is also displayed when adjusting **Contrast** or **Saturation** with manual adjustment.

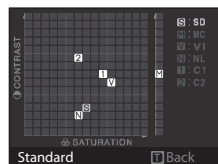

### Quick adjust<sup>1</sup>

Adjust the sharpness, contrast and saturation levels automatically. Five levels of adjustment are available from **-2** to **+2**.

Choose from options between **-2** and **+2** to reduce or emphasize the effect of the selected COOLPIX Picture Control.

The default setting is **0**.

### Image sharpening

Choose how much outlines are sharpened during shooting. Choose **A** (auto) to adjust sharpening automatically, or choose from seven levels of adjustment between **0** (no sharpening) and **6**. The higher the number, the sharper the picture, and the lower the number, the softer the picture.

The default setting is **3** for **Standard** or **Monochrome**, **2** for **Neutral** and **4** for **Vivid**.

### Contrast

Control the contrast. Choose **A** (auto) to adjust the contrast automatically according to the type of scene, or choose from seven levels of adjustment between **-3** and **+3**. **-** makes it into an image with a softer appearance, and **+** gives it a harder appearance. Choose lower values to prevent highlights in portrait subjects from being “washed out” in direct sunlight, higher values to preserve detail in misty landscapes and other low-contrast subjects.

The default setting is **0**.

### Saturation<sup>2</sup>

Control the vividness of colors. Choose **A** (auto) to adjust saturation automatically according to the type of scene, or seven levels of adjustment can be done by choosing from values between **-3** and **+3**.

Setting to the **-** side reduces the vividness, and setting to the **+** side increases the vividness.

The default setting is **0**.

### Filter effects<sup>3</sup>

Simulate the effect of color filters on monochrome photographs. Choose from **Off** (the default setting), **Y** (yellow), **O** (orange), **R** (red), and **G** (green).

**Y, O, R:**

Enhance contrast. Can be used to tone down the brightness of the sky in landscape photographs. The contrast is strengthened in the order **Y** → **O** → **R**.

**G:**

Softens skin tones. Suitable for portraits.

### Toning<sup>3</sup>

Choose the tint used in monochrome photographs from **B&W** (black-and-white, the default setting), **Sepia**, and **Cyanotype** (blue-tinted monochrome). Pressing ▼ on the rotary multi selector when **Sepia** or **Cyanotype** is selected enables you to choose from seven levels of saturation. Press ◀ or ▶ to adjust the saturation.

- 1 Quick adjust is not available in **Neutral**, **Monochrome**, **Custom 1** and **Custom 2**. The values set manually are disabled if quick adjust is used after manual setting.
- 2 Not displayed for **Monochrome**.
- 3 Only displayed for **Monochrome**.

### ✔ Note on Image Sharpening

The effects of **Image sharpening** cannot be previewed on the monitor during shooting. Check the results in playback mode.

### ✔ Note on Contrast

When **Active D-Lighting** (106) is set to settings other than **Off**, the  mark is displayed for **Contrast** and Contrast cannot be adjusted.

### ✔ Contrast, Saturation and A (Auto)

- Results for contrast and saturation vary with the exposure, and the position and size of the subject in the frame.
- The setting for the COOLPIX Picture Control which has **A** (auto) selected for either **Contrast** or **Saturation** is displayed in green in the COOLPIX Picture Control grid.

### ✎ Options that Can Be Adjusted in Custom 1 and Custom 2

The option of the original COOLPIX Picture Control can be adjusted if **Custom 1** or **Custom 2** is selected.

## Custom Picture Control (COOLPIX Custom Picture Control)

Set to P, S, A or M → MENU → P, S, A, M (shooting menu) (📖91) → Custom Picture Control

Customized picture editing options can be created and saved as Custom Picture Controls.

### Creating COOLPIX Custom Picture Controls

- 1 Use the rotary multi selector to choose **Edit and save** and press the **OK** button.

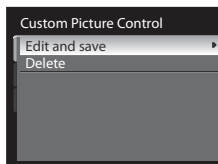

- 2 Choose the original COOLPIX Picture Control to be edited, and press the **OK** button.

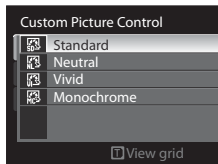

- 3 Press **▲** or **▼** to highlight the desired setting and press **◀** or **▶** to choose a value.

- The options are the same as those for adjusting the COOLPIX Picture Control.
- Press the **OK** button to display the Save as screen.
- To change the values to the default setting, select **Reset** and press the **OK** button.

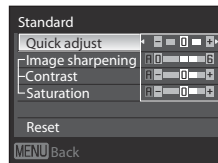

#### 4 Choose the registration destination and press the **OK** button.

- The COOLPIX Custom Picture Control is registered.
- **Custom 1** or **Custom 2** can be selected from the **Picture Control** and **Custom Picture Control** selection screen after registration.

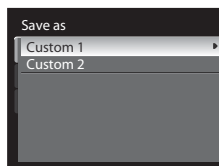

### Deleting COOLPIX Custom Picture Controls

#### 1 Use the rotary multi selector to choose **Delete** and press the **OK** button.

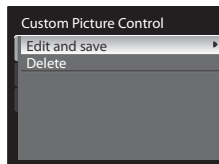

#### 2 Choose a COOLPIX Custom Picture Control to delete, and press the **OK** button.

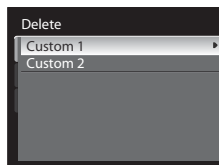

#### 3 Choose **Yes** and press the **OK** button.

- The registration is deleted.
- To cancel deletion, choose **No**.

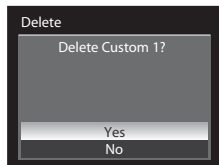

## Metering

Set to **P, S, A** or **M** → MENU → **P, S, A, M** (shooting menu) (📖91) → Metering

The process of measuring the brightness of the subject to determine the exposure is known as “metering.”

Use this option to choose how the camera meters exposure.



### Matrix (default setting)

The camera meters a wide range on the screen.

The camera sets the exposure for the entire frame. Recommended in most situations.



### Center-weighted

The camera meters the entire frame but assigns greatest weight to the subject in the center of the frame. The classic meter for portraits; it preserves background details while letting lighting conditions at the center of the frame determine exposure. Can be used with focus lock (📖29) to meter off-center subjects.



### Spot

The camera meters the area shown by the circle in the center of the frame. This can be used when the subject metering target is lighter or darker than the background. Ensure that the subject is within the area shown by the circle when shooting. Can be used with focus lock (📖29) to meter off-center subjects.



### Spot AF area

The camera meters the selected focus area to determine the exposure. Available only when a setting other than **Center (wide)**, **Center (normal)** or **Center (spot)** is selected for AF area mode (📖84).

## ✓ Notes on Metering

- When the digital zoom is in effect, at magnifications of 1.2x to 1.8x, **Metering** is set to **Center-weighted**, and at magnifications of 2.0x to 4.0x, it is set to **Spot**. Note that when the digital zoom is in effect, the metered area is not shown on the monitor.
- This feature cannot be used simultaneously with certain features. See “Functions that Cannot be Applied Simultaneously” (📖108) for more information.



### Metering in Low Noise Night Mode

**Metering** can be set even in low noise night mode (📖59). This setting is stored in the camera’s memory independently and is not linked to **Metering** in shooting modes **P, S, A** and **M**.



### Metering Area

The active metering area is displayed when **Center-weighted** or **Spot** is selected for **Metering** (📖6).



## Continuous

Set to P, S, A or M → MENU → P, S, A, M (shooting menu) (📖91) → Continuous

Change the settings for continuous shooting and BSS (Best Shot Selector).

### 📷 Single (default setting)

One image is shot each time the shutter-release button is pressed.

### 📷 Continuous

While the shutter-release button is fully held down, up to 45 pictures are shot at a rate of about 1.3 frames per second (fps) when Image quality is set to **Normal** and Image size is set to 📷 **3648×2736**.

### BSS Best Shot Selector

BSS is recommended for shooting under low lighting without the flash, with the camera zoomed in, or in other situations in which camera shake is likely to blur pictures. The camera takes up to ten images while the shutter-release button is fully held down. The sharpest image (image with the most details) in the series is automatically selected and saved.

### 📷 Continuous flash

While the shutter-release button is fully held down, continuous shooting is performed using the built-in flash (approximately 3 frames continuously at a rate of about 1.2 frames per second when Image quality is set to **Normal** and Image size is set to 📷 **3648×2736**).

The camera charges the built-in flash once continuous shooting ends. No shooting can be performed until the charging ends. Because the ISO sensitivity is raised during shooting, pictures may be affected by noise.

### 📷 Multi-shot 16

Each time the shutter-release button is fully pressed, the camera shoots 16 pictures at a rate of about 30 frames per second and arranges them in a single picture.

- The Image quality for recording is fixed to **Normal** and the Image size is fixed to 📷 (2560×1920 pixels).
- The digital zoom is not available.

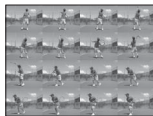

### 📷 Intvl timer shooting

The camera shoots still pictures automatically at the specified interval (📖100).

The continuous mode setting is displayed on the monitor during shooting (📖6). Nothing is displayed for **Single**.

### ✓ Notes on Continuous Shooting

- Focus, exposure and white balance are fixed at the values for the first picture in each series.
- The frame rate may become slower depending on the image quality, image size, memory card type or shooting conditions.
- When **ISO sensitivity** (📖74) is set to **3200** or **Hi 1**, the frame rate becomes slower.
- This feature cannot be used simultaneously with certain features. See “Functions that Cannot be Applied Simultaneously” (📖108) for more information.
- For details about using the built-in flash and the Speedlight (external flash unit), see “Functions that Cannot be Applied Simultaneously” (📖111).
- Do not raise or lower the built-in flash during continuous shooting. Shooting stops if the built-in flash is raised or lowered.

### ✓ Note on Best Shot Selector

**BSS** is suited for shooting stationary subjects. BSS may not produce the desired results if the subject moves or the composition changes.

### ✓ Note on Continuous Flash

The continuous flash cannot be used when the built-in flash is lowered. Raise the built-in flash when using the continuous flash to shoot.

### ✓ Note on Multi-shot 16

Smear (📖198) visible in the monitor when shooting with **Multi-shot 16** enabled will be recorded with images. Avoiding bright objects such as the sun, reflections of the sun, and electric lights when shooting with **Multi-shot 16** enabled is recommended.

### 🔑 Continuous Shooting in Low Noise Night Mode

**Continuous** can be set to **Single** or **Continuous** even in low noise night mode (📖59). This setting is stored in the camera's memory independently and is not linked to **Continuous** in shooting modes **P**, **S**, **A** and **M**.

## Interval Timer Shooting

Pictures are shot automatically at the specified intervals.

Choose from **30 s**, **1 min**, **5 min**, or **10 min**.

- 1 Display the shooting menu (📖91), use the rotary multi selector to select **Intvl timer shooting** for the **Continuous** setting, and then press the **OK** button.

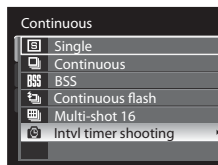

## 2 Choose the interval between each shot and press the **OK** button.

- The maximum amount of frames that can be taken during interval timer shooting differs according to the interval taken between each shot.
  - 30 s:** 600 images
  - 1 min:** 300 images
  - 5 min:** 60 images
  - 10 min:** 30 images

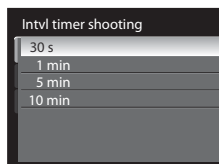

## 3 Press the **MENU** button.

- The camera returns to shooting mode.

## 4 Press the shutter-release button all the way down to shoot the first picture and start interval timer shooting.

- The monitor is turned off and the power-on lamp blinks between shots.
- The monitor reactivates automatically immediately before the next picture is shot.

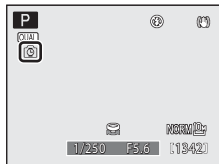

## 5 Press the shutter-release button all the way down again to finish shooting.

- Shooting finishes automatically if the internal memory or memory card becomes full, or when the number of shot frames reaches the upper limit.

### **✓** Notes on Interval Timer Shooting

- To prevent the camera from turning off unexpectedly during shooting, use a fully charged battery.
- To power the camera continuously for extended periods, use the AC Adapter EH-5a and the Power Connector EP-5A (available separately). Do not, under any circumstances, use an AC Adapter other than the EH-5a or a Power Connector other than the EP-5A. Failure to observe this precaution could result in overheating or damage to the camera.
- Do not rotate the mode dial to a different setting while performing interval timer shooting.

### **📖** More Information

See "File and Folder Names" (📖203) for more information.

## Autofocus Mode

Set to P, S, A or M → MENU → P, S, A, M (shooting menu) (📖91) → Autofocus mode

Choose how the camera focuses.

 Single AF (default setting)

The camera focuses only when the shutter-release button is pressed halfway.

 Full-time AF

The camera focuses continuously until the shutter-release button is pressed down halfway. Use with moving subjects. A sound will be heard while the camera focuses.

### Note on Autofocus Mode

This feature cannot be used simultaneously with certain features. See “Functions that Cannot be Applied Simultaneously” (📖108) for more information.

## Flash Exp. Comp.

Set to P, S, A or M → MENU → P, S, A, M (shooting menu) (📖91) → Flash exp. comp.

Flash compensation is used to adjust the flash output by  $\pm 2.0$  EV in increments of 1/3 EV, changing the brightness of the main subject relative to the background.

-0.3 to -2.0

The flash output is reduced from -0.3 to -2.0 EV, in increments of 1/3 EV, to prevent unwanted highlights or reflections.

0.0 (default setting)

The flash output is not adjusted.

+0.3 to +2.0

The flash output is increased from +0.3 to +2.0 EV, in increments of 1/3 EV, to make the main subject of the frame appear brighter.

At settings other than **0.0**, the icon for the current setting is displayed on the monitor (📖6).

### Flash Exp. Comp. in Low Noise Night Mode

**Flash exp. comp.** can be set even in low noise night mode (📖59). This setting is stored in the camera's memory independently and is not linked to **Flash exp. comp.** in shooting modes P, S, A and M.

## Noise Reduction Filter

Set to P, S, A or M → MENU → P, S, A, M (shooting menu) (📖91) → Noise reduction filter

Set the strength of the noise reduction function that is normally performed when recording the picture.

- For noise at slow shutter speeds, set with **Long exposure NR** (📖103).

**NR** Normal (default setting)

Perform noise reduction at the standard strength.

**NR** Low

Perform noise reduction at a level lower than the standard strength.

The setting for the noise reduction filter is shown by an icon displayed on the monitor during shooting (📖6). Nothing is displayed for **Normal**.

## Long Exposure NR

Set to P, S, A or M → MENU → P, S, A, M (shooting menu) (📖91) → Long exposure NR

At slow shutter speeds, pictures may be affected by “noise” in the form of randomly-spaced, brightly-colored dots concentrated in dark parts of the image. Reduce noise at slow shutter speeds. Enabling long exposure NR increases the time needed to record pictures after they are shot.

**AUTO** Auto (default setting)

Noise reduction is performed at slow shutter speeds that are likely to result in pictures affected by noise.

**ENR** On

Noise reduction is applied to pictures shot at shutter speeds of 1/4 second or slower. Switching this to **On** is recommended when shooting at slow shutter speeds.

When long exposure NR is performed, the **ENR** icon is displayed on the monitor during shooting (📖6).

### Note on Long Exposure NR

This feature cannot be used simultaneously with certain features. See “Functions that Cannot be Applied Simultaneously” (📖108) for more information.

## Distortion Control

Set to **P, S, A** or **M** → MENU → **P, S, A, M** (shooting menu) (📖91) → Distortion control

Choose whether to correct the peripheral distortion that occurs due to the intrinsic characteristics of lenses. Enabling distortion control reduces the size of the frame, as compared to when distortion control is not enabled.



**On**

Distortion is corrected.



**Off (default setting)**

No distortion correction is performed.

When distortion control is enabled, the current setting is displayed during shooting (📖6). When **Off** is selected, an icon for the current setting is not displayed.



### Note on Distortion Control

This feature cannot be used simultaneously with certain features. See “Functions that Cannot be Applied Simultaneously” (📖108) for more information.

## Wide-angle Converter

Set to **P, S, A** or **M** → MENU → **P, S, A, M** (shooting menu) (📖91) → Wide-angle converter

Set when the Wide-angle Converter WC-E75A (0.75×) (available separately from Nikon) is mounted.

The Adapter Ring UR-E22 (available separately from Nikon) is also required for mounting.



**On**

Set when using the Wide-angle Converter WC-E75A. The angle of view when the WC-E75A is mounted is equivalent to about 21 mm in 35mm [135] format (when **Distortion control** is set to **Off**). The zoom lens is fixed to the wide-angle end. The digital zoom is not available.





**None (default setting)**

Use when no converter lens is attached (be sure to remove the lens adapter ring and attach the lens ring).

The setting for the wide-angle converter is shown by an icon displayed on the monitor during shooting (📖6). Nothing is displayed when the setting is **None**.

**✓ Notes on the Wide-angle Converter for Shooting**

- Set **Wide-angle converter** to **On** before shooting. Set **Wide-angle converter** to **None** when no converter lens is attached.
- The built-in flash is changed to  (Off) when **Wide-angle converter** is set to **On**. Use flash units (202) (available separately from Nikon) to shoot with the flash.
- Using the flash units (available separately from Nikon) may darken the peripheral area of the picture. Check the picture using the monitor after shooting. A wide panel is recommended when shooting with the Speedlight SB-600 or SB-900.
- AF Assist illuminator cannot be used when **Wide-angle converter** is set to **On**.
- This feature cannot be used simultaneously with certain features. See “Functions that Cannot be Applied Simultaneously” (108) for more information.

**✎ Installing and Removing the Lens Ring**

- Before attaching the wide-angle converter, remove the lens ring. Before installing or removing the lens ring, be sure to turn off the camera. While pressing the lens ring release button, rotate the lens ring clockwise and remove it.
- To attach the lens ring to the camera, align the lens ring mounting index (white dot) with the lens ring release button, and then rotate the lens ring counterclockwise.
- When not using the wide-angle converter, be sure to attach the lens ring onto the camera.
- For more information on attaching the wide-angle converter, see the user’s manual provided with the wide-angle converter.

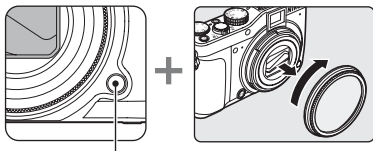

Lens ring release button

**Flash Control**

Set to P, S, A or M → MENU → P, S, A, M (shooting menu) (91) → Flash control

You can set the built-in flash to off even when you are not using a Speedlight (external flash unit) (202) mounted on the camera’s accessory shoe.

**AUTO** Auto (default setting)

When a flash unit is mounted, the flash unit fires. When a flash unit is not used, the built-in flash fires.

**OFF** Built-in off

The built-in flash is disabled.



**✓ Note on Flash Control**

This feature cannot be used simultaneously with certain features. See “Functions that Cannot be Applied Simultaneously” (108) for more information.

## Active D-Lighting

Set to P, S, A or M → MENU → P, S, A, M (shooting menu) (📖91) → Active D-Lighting

“Active D-Lighting” preserves details in highlights and shadows, creating photographs with natural contrast. The image taken reproduces the contrast effect that is seen with the naked eye. This is particularly effective for shooting scenes with high contrast, such as brightly lit outdoor scenery from a dark room or shaded subjects at a sunny seaside.

 High,  Normal,  Low

Set the level of the Active D-Lighting effect that is applied during shooting.

**OFF** Off (default setting)

Active D-Lighting is not applied.

When Active D-Lighting is enabled, the current setting is displayed during shooting (📖6). When **Off** is selected, an icon for the current setting is not displayed.

### Active D-Lighting

- Additional time is required to record images when shooting using Active D-Lighting.
- The exposure is reduced in comparison to shooting with Active D-Lighting set to **Off**. To ensure that the gradation is appropriate, adjustments of the highlighted areas, shadow areas and mid-tones are made before recording.
- This feature cannot be used simultaneously with certain features. See “Functions that Cannot be Applied Simultaneously” (📖108) for more information.

### Active D-Lighting Versus D-Lighting

The **Active D-Lighting** option in the shooting menu adjusts exposure before shooting to optimize the dynamic range. The **D-Lighting** (📖136) option in the playback menu optimizes dynamic range in images after shooting.



## Zoom Memory

Set to P, S, A or M → MENU → P, S, A, M (shooting menu) (📖91) → Zoom memory

When the zoom control is operated while pressing the **Fn** button, the camera changes in steps to the focal length (equivalent to 35mm [135] format of angle of view) of the zoom lens that is set in advance in **Zoom memory**. The following settings are available: **28 mm, 35 mm, 50 mm, 85 mm, 105 mm, 135 mm** and **200 mm**.

- Choose the focal length with the rotary multi selector, and then press the **OK** button to set the check box to on  or off.
- Multiple focal lengths can be chosen.
- The default setting is on  for all the check boxes.
- To finish the setting, press the rotary multi selector **◀**.

### Notes on Zoom Operation

- Operate the zoom control while pressing the **Fn** button to change the zoom position to focal length for which the zoom memory is set to on (📖11).  
The changed focal length is the closest to that before the operation. To change the zoom position to the next focal length level, release the zoom control and then operate it again.
- Release your finger from the **Fn** button when using the digital zoom.

## Functions that Cannot be Applied Simultaneously

The flash mode, the focus mode, the self-timer/smile timer/remote control, the quick menu, the shooting menu and the specialized menu for **U1**, **U2** or **U3** cannot be used with other functions.





Restricted function	Setting	Description
Flash mode	Focus mode (40)	When  (Infinity) is selected for shooting, the flash is not available.
	Continuous (99)	<ul style="list-style-type: none"> <li>When <b>BSS</b> or <b>Multi-shot 16</b> is selected for shooting, the flash is not available.</li> <li>When <b>Continuous</b> is selected for shooting, the built-in flash is not available (111).</li> <li>The built-in flash is fixed to  (Fill flash) when <b>Continuous flash</b> is selected for shooting. The Speedlight (external flash unit) cannot be used (111).</li> </ul>
	Auto bracketing (80)	The built-in flash is not available.
	Wide-angle converter (104)	The flash is not available when <b>On</b> is set for shooting.
	Flash control (105)	When <b>Flash control</b> is set to <b>Built-in off</b> ,  (Auto with red-eye reduction),  (Manual),  (Slow sync) and  (Rear-curtain sync) flash modes cannot be selected.
Self-timer/Smile timer/Remote control	AF area mode (84)	When <b>Subject tracking</b> is selected for shooting, the Self-timer/Smile timer/Remote control are not available.
Focus mode	Continuous (99)	(Infinity) cannot be used when <b>Continuous flash</b> is set for shooting.
	Smile timer (36)	When shooting with the Smile timer, the mode is changed to <b>AF</b> (autofocus).
	AF area mode (84)	When <b>Subject tracking</b> is selected for shooting, <b>MF</b> (manual focus) is not available.
Image quality	Continuous (99)	When <b>Multi-shot 16</b> is selected for shooting, <b>Image quality</b> is fixed to <b>Normal</b> .
Image size	Image quality (68)	<ul style="list-style-type: none"> <li><b>Image size</b> is fixed to  <b>3648x2736</b> when <b>NRW (RAW)</b> is selected for <b>Image quality</b>.</li> <li><b>Image size</b> for a JPEG image can be set when <b>NRW (RAW) + Fine</b>, <b>NRW (RAW) + Normal</b> or <b>NRW (RAW) + Basic</b> is selected. However,  <b>3648x2432</b>,  <b>3584x2016</b> and  <b>2736x2736</b> cannot be selected.</li> </ul>
	Continuous (99)	<b>Image size</b> is fixed to  (2560x1920 pixels) when <b>Multi-shot 16</b> is selected for shooting.

## Shooting Options: Shooting Menu (P, S, A, M Modes)

Restricted function	Setting	Description
ISO sensitivity	Continuous (99)	When shooting in <b>Multi-shot 16</b> , <b>ISO sensitivity</b> is set automatically according to the brightness when shooting mode <b>P</b> , <b>S</b> or <b>A</b> is used. The setting for ISO sensitivity is fixed at 400 for shooting mode <b>M</b> .
	Picture Control (92)	<b>White balance</b> is fixed to <b>Auto</b> when <b>Monochrome</b> is selected for shooting.
White balance	Wide-angle converter (104)	When <b>On</b> is selected for shooting, <b>Preset manual</b> is not available.
	Focus mode (40)	<ul style="list-style-type: none"> <li>When a setting other than <b>Subject tracking</b> is selected and  (Infinity) is selected as the focus mode for shooting, the camera focuses at infinity regardless of the applied AF area mode option.</li> <li>When set to <b>MF</b> (manual focus), the AF area mode cannot be set.</li> </ul>
AF area mode	Picture Control (92)	When <b>Picture Control</b> is set to <b>Monochrome</b> while AF area mode is set to <b>Subject tracking</b> , the AF area mode setting automatically changes to <b>Auto</b> .
	Active D-Lighting (106)	When using <b>Active D-Lighting</b> for shooting, <b>Contrast</b> in Manual adjustment cannot be adjusted.
Metering	AF area mode (84)	<ul style="list-style-type: none"> <li>When AF area mode is set to <b>Center (wide)</b>, <b>Center (normal)</b> or <b>Center (spot)</b> while <b>Metering</b> is set to <b>Spot AF area</b>, the <b>Metering</b> setting automatically changes to <b>Matrix</b>.</li> <li>When AF area mode is set to <b>Subject tracking</b> while <b>Metering</b> is set to <b>Spot</b>, the <b>Metering</b> setting automatically changes to <b>Matrix</b>.</li> </ul>
	Active D-Lighting (106)	<b>Metering</b> is reset to <b>Matrix</b> when <b>Active D-Lighting</b> is set to any mode other than <b>Off</b> .
Continuous/Auto bracketing	Continuous (99)/Auto bracketing (80)	<b>Continuous</b> and <b>Auto bracketing</b> are not available simultaneously. <b>Auto bracketing</b> is reset to <b>Off</b> when Continuous is set to any mode other than <b>Single</b> . The setting for continuous is reset to <b>Single</b> when <b>Auto bracketing</b> is set to any mode other than <b>Off</b> .
	Self-timer (35)/ Smile timer (36)/Remote control (38)	<b>Continuous</b> , <b>BSS</b> , <b>Continuous flash</b> , <b>Multi-shot 16</b> , <b>Intvl timer shooting</b> or <b>Auto bracketing</b> and the Self-timer/Remote control/Smile timer are not available simultaneously.
	Image quality (68)	<b>BSS</b> , <b>Multi-shot 16</b> or <b>White balance bracketing</b> cannot be used when <b>Image quality</b> is set to <b>NRW (RAW)</b> , <b>NRW (RAW) + Fine</b> , <b>NRW (RAW) + Normal</b> or <b>NRW (RAW) + Basic</b> .

## Shooting Options: Shooting Menu (P, S, A, M Modes)

Restricted function	Setting	Description
Continuous/Auto bracketing	Picture Control (📖92)	<b>White balance bracketing</b> cannot be used when <b>Monochrome</b> is selected for shooting.
	Long exposure NR (📖103)	When <b>On</b> is selected for <b>Long exposure NR, Multi-shot 16</b> is not available.
	Distortion control (📖104)	When <b>Distortion control</b> is set to <b>On</b> , <b>Multi-shot 16</b> and <b>Intvl timer shooting</b> are not available.
	Wide-angle converter (📖104)	<b>Continuous flash</b> cannot be used when <b>On</b> is set for shooting.
Long exposure NR	Continuous (📖99)	When <b>Multi-shot 16</b> is selected for shooting, the Long exposure NR is not available.
Distortion control	Continuous (📖99)	Distortion control cannot be used when <b>Multi-shot 16</b> or <b>Intvl timer shooting</b> is selected for shooting.
Active D-Lighting	ISO sensitivity (📖74)	When <b>ISO sensitivity</b> is set to <b>3200</b> or <b>Hi 1</b> , <b>Active D-Lighting</b> is not available. When <b>3200</b> or <b>Hi 1</b> is selected, <b>Active D-Lighting</b> is reset to <b>Off</b> .
Date imprint	Image quality (📖68)	Date imprint is not available when <b>Image quality</b> is set to <b>NRW (RAW), NRW (RAW) + Fine, NRW (RAW) + Normal</b> or <b>NRW (RAW) + Basic</b> .
	Continuous (📖99)	When <b>Continuous, BSS</b> or <b>Continuous flash</b> is selected for shooting, date imprint is not available.
	Auto bracketing (📖80)	Date imprint is not available.
Photo info.	Smile timer (📖36)	The virtual horizon is not displayed when shooting with the smile timer.
	AF area mode (📖84)	The virtual horizon and histogram are not displayed when shooting with <b>Subject tracking</b> .
Blink warning	Smile timer (📖36)/ Continuous (📖99)/Auto bracketing (📖80)	Blink warning does not take effect when using the Smile timer, Continuous is set to a setting other than <b>Single</b> , or auto bracketing is set.
	Tone level information (📖82)	Blink warning does not take effect when the tone level information is displayed automatically.
Digital zoom	Smile timer (📖36)	The digital zoom cannot be used when shooting with the Smile timer.
	Focus mode (📖40)	The digital zoom cannot be used when <b>MF</b> (manual focus) is selected.
	AF area mode (📖84)	The digital zoom cannot be used when shooting with <b>Subject tracking</b> .



Restricted function	Setting	Description
Digital zoom	Image quality (  68)	The digital zoom cannot be used when <b>Image quality</b> is set to <b>NRW (RAW)</b> , <b>NRW (RAW) + Fine</b> , <b>NRW (RAW) + Normal</b> or <b>NRW (RAW) + Basic</b> .
	Continuous (  99)	The digital zoom cannot be used when <b>Multi-shot 16</b> is selected for shooting.
Slow shutter speed	ISO sensitivity (  74)	<ul style="list-style-type: none"> <li>When the shooting mode is <b>P</b>, <b>S</b> or <b>A</b>, the slowest shutter speed is restricted to four seconds when the <b>ISO sensitivity</b> is <b>High ISO sensitivity auto</b> or <b>1600</b>, 1/2 second when the <b>ISO sensitivity</b> is <b>3200</b>, and 1/8 second when the <b>ISO sensitivity</b> is <b>Hi 1</b>.</li> <li>When the shooting mode is <b>M</b>, the slowest shutter speed is restricted to 15 seconds when the <b>ISO sensitivity</b> is <b>800</b>, four seconds when the <b>ISO sensitivity</b> is <b>1600</b>, 1/2 second when the <b>ISO sensitivity</b> is <b>3200</b>, and 1/8 second when the <b>ISO sensitivity</b> is <b>Hi 1</b>.</li> </ul>
	Continuous (  99)	<ul style="list-style-type: none"> <li>When <b>Continuous</b>, <b>BSS</b> or <b>Continuous flash</b> is selected for shooting, the slowest shutter speed is restricted to 1/2 second.</li> <li>When <b>Multi-shot 16</b> is selected for shooting, the slowest shutter speed is restricted to 1/30 second.</li> </ul>

### Built-in flash, Speedlights (external flash unit)

The operation of the built-in flash and the Speedlight SB-400, SB-600 and SB-900 flash units (available separately from Nikon) are restricted as shown below, depending on the Continuous setting that is applied.

Continuous mode	Built-in flash	Flash units*
Single	Available	Available
Continuous	Off	Available
BSS	Off	Not available
Continuous flash	Available	Not available
Multi-shot 16	Off	Not available
Intvl timer shooting	Available	Available
Auto bracketing	Off	Available

When a flash unit (available separately from Nikon) is mounted on the camera's accessory shoe, the built-in flash is automatically set to  (Off).

\* When shooting using **Continuous** or Auto bracketing with the flash mode set to  (Auto with red-eye reduction) (32, 34), only the pre-flash element of red-eye reduction is performed.

### More Information

See "Notes on Digital Zoom" (178) for more information.

# U1, U2 and U3 (User Setting Modes)

Up to three setting combinations that are frequently used for shooting (user settings) can be saved in **U1**, **U2** and **U3**. The saved settings can be immediately retrieved for shooting simply by rotating the mode dial to **U1**, **U2** or **U3**. This is convenient when you want to shoot with these settings, or you only want to slightly change the settings. Shooting is possible in **P** (Programmed auto), **S** (Shutter-priority auto), **A** (Aperture-priority auto) and **M** (Manual). The following settings can be saved in **U1**, **U2** or **U3**.

## Specialized Menu for U1, U2 or U3

Shooting mode (60) <sup>1</sup>	Focal length (35mm equiv.) <sup>2</sup>	Photo info (173) <sup>3</sup>
Initial monitor display (14) <sup>4</sup>	Flash mode (32)	Focus mode (40) <sup>5</sup>
AF area mode (84) <sup>6</sup>	AF assist (177) <sup>3</sup>	

## Quick Menu

Image quality (68)	Image size (70)	ISO sensitivity (74)
White balance (76) <sup>7</sup>	Auto bracketing (80)	

## Shooting Menu

Picture Control (92)	Metering (98)	Continuous (99)
Autofocus mode (102)	Flash exp. comp. (102)	Noise reduction filter (103)
Long exposure NR (103)	Distortion control (104)	Wide-angle converter (104)
Flash control (105)	Active D-Lighting (106)	Zoom memory (107)

- 1 Choose the standard shooting mode (default setting is **P**). The current flexible program (when set to **P**), shutter speed (when set to **S** or **M**) or aperture value (when set to **A** or **M**) settings are also saved.
- 2 Set the zoom position for when the mode dial is set. Choose **28 mm** (default setting), **35 mm**, **50 mm**, **85 mm**, **105 mm**, **135 mm**, **200 mm** or **Current zoom position**.
- 3 This setting is not applied to the setup menu settings.
- 4 Set the information displayed on the monitor when the mode dial is set (default setting is **Show info**).
- 5 The current focus distance is also saved when the focus mode is **MF** (manual focus).
- 6 The current focus area position is saved when AF area mode is set to **Manual**.
- 7 The preset value for preset manual applies to the **P**, **S**, **A**, **M**, **U1**, **U2** and **U3** shooting modes.

## Save the Settings in U1, U2 or U3

The frequently used settings for shooting can be changed and saved in U1, U2 and U3.

### 1 Rotate the mode dial to U1, U2 or U3.

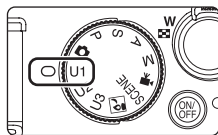

### 2 Change to a frequently used combination of shooting settings.

- Press the **MENU** button to display the menu and switch between tabs with the rotary multi selector (📖13).
  - **U1, U2 U3** tabs: Display the specialized menus for **U1, U2** and **U3**.
  - **P, S, A, M** tabs: Display the shooting menus.
- Display the quick menu by pressing the quick menu button (📖10, 67).
- Use the rotary multi selector to select and set menu options (📖12).

### 3 After changing the settings, choose **Save user settings** in the specialized menu for U1, U2 or U3, and press the **OK** button.

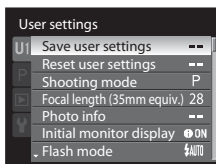

### 4 Choose **Yes** and press the **OK** button.

- The current settings are saved.
- Rotate the zoom control to **T** (Q) to show the settings.

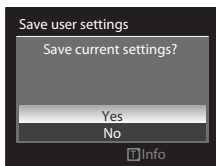

## 🔋 Clock battery

If the internal clock battery (📖171) is exhausted, the settings saved in U1, U2 or U3 will be reset. Writing down any important setting is recommended.

### Shooting in U1, U2 or U3 (User Setting) Mode

Rotate the mode dial to **U1**, **U2** or **U3** to retrieve the settings saved in “Save the Settings in U1, U2 or U3” (113).

- Frame the subject and shoot with these settings, or change the settings as required.
- The setting combinations that are retrieved when the mode dial is rotated to **U1**, **U2** or **U3** can be changed as many times as you want in **Save user settings**.

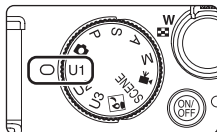

### Resetting Saved Settings

The settings that are saved for **U1**, **U2** and **U3** can be reset.

#### 1 Rotate the mode dial to **U1**, **U2** or **U3**.

- Set the user setting mode to reset.

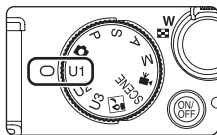

#### 2 In the specialized menu screen for **U1**, **U2** or **U3**, choose **Reset user settings** and press the **OK** button.

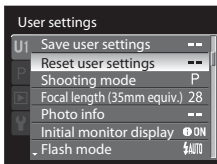

#### 3 Choose **Yes** and press the **OK** button.

- The saved settings are reset.

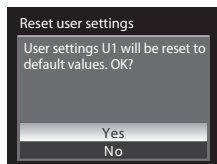



### Resetting for U1, U2 and U3

The settings that are saved in the user settings are reset as follows:









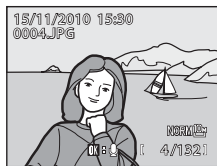













- Specialized menus for **U1**, **U2** and **U3**: **Shooting mode: P Programmed auto, Focal length: 28 mm, Photo info: information hidden, Initial monitor display: Show info, Flash mode: \$AUTO Auto, Focus: AF Autofocus, AF area mode: Auto, AF assist: Auto**
- Shooting menu, quick menu: Same as the default setting for each item





## Operations in Full-Frame Playback

In shooting mode, press the  (playback) button to enter playback mode and play back the images that have been shot ( 30). The following operations can be performed in full-frame playback mode.



To	Use	Description	
Choose pictures		Press  ,  ,  or  to choose a picture to display. Press and hold  ,  ,  or  to fast forward pictures. Pictures can also be chosen by rotating the rotary multi selector or the command dial.	12
Thumbnail display/ Calendar display (except for list by date mode)		Display images by 4, 9 or 16 picture thumbnails. Rotate the zoom control towards the  in the 16-picture thumbnail display to change to the calendar display.	116, 117
Choose the date of recording again for playback (list by date mode)		Rotate the zoom control towards the  in full-frame playback mode to return to the list by date screen.	119
Playback zoom		Enlarge the view of the picture currently displayed on the monitor, up to about 10x. Press the  button to return to the full-frame playback mode.	118
Switch between displays		Hide or show the shooting information, photo information and tone level information on the monitor.	14, 82
Record/play voice memos		Record or play back voice memos up to 20 seconds in length.	132
Play back movies		Play back the displayed movies.	151
Delete pictures		Delete the displayed pictures.	31
Display menu	<b>MENU</b>	Display the playback menu.	123
Choose a picture on a specified date		Switch to list by date mode.	119
Switch to shooting mode		Press the  button or shutter-release button to enter the shooting mode.	30
			

### Changing the Orientation (Vertical and Horizontal Positioning) of Pictures

Change using **Rotate image** ( 130) in the playback menu after shooting ( 122).

## Viewing Multiple Pictures: Thumbnail Playback

Rotate the zoom control to **W** (📐) in full-frame playback mode (📖30, 115) to display pictures as thumbnail images in thumbnail playback mode (except for list by date mode).



The following operations can be performed in thumbnail playback mode.

To	Use	Description	
Choose pictures		Rotate the rotary multi selector, or press ▲, ▼, ◀, or ▶.	12
		Rotate the command dial.	9
Increase the number of thumbnails displayed/Calendar display	<b>W</b> (📐)	Rotate the zoom control towards the <b>W</b> (📐) direction to increase the number of thumbnails from 4 → 9 → 16 → Calendar display. In calendar display, the images can be selected according to date by moving the cursor (📖117). Rotate towards the <b>T</b> (📐) direction to return to thumbnail display.	-
Decrease number of picture thumbnails displayed	<b>T</b> (📐)	Rotate the zoom control towards the <b>T</b> (📐) direction to decrease the number of thumbnails from 16 → 9 → 4. Rotate towards <b>T</b> (📐) again during 4 thumbnails display to return to full-frame playback.	-
Return to full-frame playback		Press the  button.	30, 115
Delete pictures		Delete the selected picture.	31
Switch to the shooting mode		Press the  button or shutter-release button to enter the shooting mode.	30

## Icons on the Thumbnails

When pictures with **Print set** (📖123) and **Protect** (📖129) settings are selected, the icons shown on the right appear. Movies are displayed as film frames.

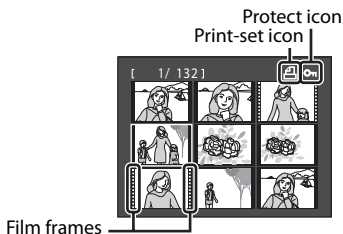

## Calendar Display

Rotate the zoom control towards **W** (🗘) during playback mode when 16 thumbnails are displayed (📖116) to change to calendar display. Move the cursor and choose images by selecting a date. Dates for which pictures exist are underlined in yellow.



The following operations can be performed in calendar display mode.

To	Use	Description	📖
Select date		Rotate the rotary multi selector, or press ▲, ▼, ◀, or ▶.	12
		Rotate the command dial.	9
Return to full-frame playback		Change to full-frame playback for displaying the first picture for that date.	30, 115
Return to picture list display	<b>T</b> (🗘)	Rotate the zoom control to <b>T</b> (🗘).	-

## Notes on Calendar display

- Images taken without the date set are treated as images taken on "January 1, 2010."
- **MENU** and buttons are disabled while the Calendar is displayed.

## List by Date Mode

Only the pictures taken on the same date can be played back in list by date mode (📖119). The list by date options (📖121) are also available only for the pictures taken on the selected dates.

## Taking a Closer Look: Playback Zoom

Rotate the zoom control to **T** (Q) in full-frame playback mode (📖30) to zoom in on the current picture, enlarging and displaying the center of the picture.

- The guide at lower right shows which portion is enlarged. The following operations can be performed while pictures are zoomed in.



To	Use	Description	📖
Zoom in	<b>T</b> (Q)	Rotate the zoom control to <b>T</b> (Q). The zoom increases up to about 10x. Zoom also increases by rotating the command dial to the right.	-
Zoom out	<b>W</b> (📐)	Rotate the zoom control to <b>W</b> (📐). When the magnification ratio reaches 1x, the display returns to full-frame playback mode. Zoom also decreases by rotating the command dial to the left.	-
Move the display area		Press the rotary multi selector ▲, ▼, ◀ or ▶ to move the display area to other areas of the picture.	12
Return to full-frame playback		Press the  button.	30, 115
Crop picture	<b>MENU</b>	Press to save the visible portion only as a separate file.	145
Switch to the shooting mode		Press the  button or shutter-release button to enter the shooting mode.	30

### Pictures Taken Using the Face Priority Function

When the zoom control is rotated to **T** (Q) during full-frame playback mode for pictures taken in Face Priority (📖86), the picture is enlarged with the face that was detected during shooting at the center (excluding pictures that were shot using **Continuous** (📖99) or **Auto bracketing** (📖80)).



- If more than one face was detected, the picture is enlarged with the face that was focused on at the center of the monitor. Press the rotary multi selector ▲, ▼, ◀, or ▶ to display other faces that were detected.
- When the zoom control is further rotated in the **T** (Q) or **W** (📐) direction, the zoom ratio changes and becomes a normal playback zoom display.

## Viewing Pictures by Date (List by Date)

In list by date mode, pictures taken on the same date can be played back.

- In full-frame playback, zooming of images, editing, and movie playback can be performed in the same way as in the normal playback mode. Recording and playback of voice memos can also be performed.
- When the **MENU** button is pressed and the list by date menu (📅 121) is displayed, all pictures shot on a specified date can be selected for deletion at the same time, or slide show, print set or protection can be performed only for the pictures shot on a specified date.

### Selecting a Date in List by Date Mode

- 1 Press the AE-L/AF-L (📷) button during playback.

- The list by date screen is displayed.

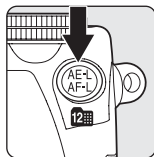

- 2 Use the rotary multi selector to select the desired date.

- The camera lists up to 29 dates. If pictures exist for more than 29 dates, all pictures recorded earlier than the most recent 29 dates are listed together as **Others**.
- For the detailed operations in the list by date screen, see “Operations in List by Date Mode” (📖 120).
- Press the **OK** button to display the first picture for that date in full-frame playback.
- Rotate the zoom control to **W** (📷) in full-frame playback mode or when displaying the shooting information to return to the list by date screen.
- Press the AE-L/AF-L button to return to the normal playback mode.

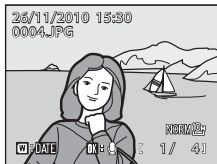
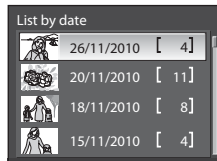









### Notes on List by Date Mode

- Only the most recent 9,000 pictures can be displayed in list by date mode. If a date includes the 9,001st picture, an asterisk (\*) is displayed next to the number of pictures for that date.
- Pictures shot when the date was not set are handled as “January 1, 2010.”















## Operations in List by Date Mode

The following operations are possible from the list by date screen (Step 2 of  119).

To	Use	Description	
Select date		Rotate the rotary multi selector, or press <b>▲</b> or <b>▼</b> . The date can also be selected by rotating the command dial.	12
Switch to full-frame playback		Display the picture shot on the selected date in full-frame playback mode. Rotate the zoom control to <b>W</b>  in full-frame playback to return to the list by date screen.	30
Delete Pictures		Delete all pictures of the chosen date. Choose <b>Yes</b> on the deletion confirmation screen.	31
View list by date menu	<b>MENU</b>	Display the list by date menu.	121
Switch to the normal playback mode		Switch to the normal playback mode.	115
Switch to the shooting mode		Press the  button or shutter-release button to enter the shooting mode.	30
			

## List by Date Menus

In list by date mode, press the **MENU** button to enable the following operations for only the pictures shot on the specified date.

Quick retouch*	→  135
D-Lighting*	→  136
Print set	→  123
Slide show	→  126
Delete	→  127
Protect	→  129
Rotate image*	→  130
Hide image	→  130
Small picture*	→  137
Black border*	→  138
Skin softening*	→  139
Straighten*	→  141
Miniature effect*	→  142
NRW (RAW) processing*	→  143

\* During full-frame playback only

When the **MENU** button is pressed in the list by date screen ( 119), options can be applied to all pictures shot on the same date, or all pictures shot on the same date can be deleted.

To apply options to individual pictures, or to select individual pictures for deletion, display a full-frame picture and press the **MENU** button.



## Playback Options: Playback Menu

The following options are available in playback menu.

	<b>Quick retouch</b>  135
	Easily create retouched images in which contrast and saturation have been enhanced.
	<b>D-Lighting</b>  136
	Enhance brightness and contrast in dark portions of pictures.
	<b>Print set</b>  123
	Select pictures to print and the number of copies for each.
	<b>Slide show</b>  126
	View pictures stored in the internal memory or on a memory card in an automatic slide show.
	<b>Delete</b>  127
	Delete a picture. Multiple pictures can be deleted.
	<b>Protect</b>  129
	Protect selected pictures from accidental deletion.
	<b>Rotate image</b>  130
	Change the orientation of an existing picture.
	<b>Hide image</b>  130
	Hide the selected pictures so that they cannot be played back on the camera screen.
	<b>Small picture</b>  137
	Create a small copy of the picture taken.
	<b>Copy</b>  131
	Copy files between the memory card and internal memory.
	<b>Black border</b>  138
	Create a new picture surrounded by a black border.
	<b>Skin softening</b>  139
	Make the subject's skin appear smoother.
	<b>Straighten</b>  141
	Compensate for the slanting of shot pictures.
	<b>Miniature effect</b>  142
	Create a copy that appears to be a photo of a diorama.
<b>NRW</b>	<b>NRW (RAW) processing</b>  143
	Create JPEG images by RAW processing NRW (RAW) images.



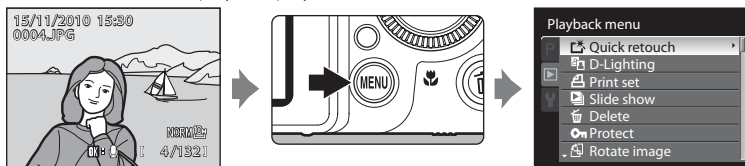

## Displaying the Playback Menu

Press the **MENU** button to display the menu, use the rotary multi selector to change to the  tab and display the playback menu ( 13).





- Use the rotary multi selector to select items and set functions on menus ( 12).
- To exit the playback menu, press the **MENU** button.

## Print Set: Setting the Pictures and Number of Copies to Print

Press the **MENU** button →  (Playback menu) ( 123) →  Print set

If you choose to use one of the following methods to print pictures that are recorded on a memory card, the pictures to print and the number of copies can be set in advance on the memory card.

- Printing with a DPOF-compatible ( 220) printer that is equipped with a card slot.
- Ordering the prints from a digital photo lab that has a DPOF service.
- Printing by connecting the camera to a PictBridge-compatible ( 220) printer ( 161). (When the memory card is removed from the camera, the print settings can also be performed for the pictures recorded on the internal memory.)

- 1 Choose **Select images** and press the  button.

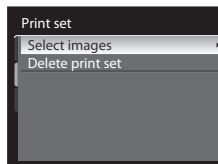

## 2 Choose the pictures (up to a maximum of 99) and number of copies (up to nine per picture).

- Rotate the rotary multi selector or press ◀ or ▶ to choose the pictures, and press ▲ or ▼ to set the number of copies for each.
- Pictures can also be chosen by rotating the command dial.
- Pictures selected for printing can be recognized by the check mark icon and the numeral indicating the number of copies to be printed. A check mark is not displayed with pictures for which no copies have been specified and these pictures are not printed.
- Rotate the zoom control to **T** (Q) to switch to full-frame playback, or **W** (Q) to switch to 12 thumbnails display.
- Press the **OK** button when setting is complete.

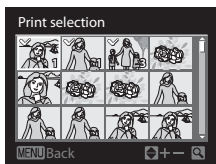

## 3 Choose whether or not to also print shooting date and photo information.

- Choose **Date** and press the **OK** button to print the shooting date on all pictures in the print order.
- Choose **Info** and press the **OK** button to print shooting information (shutter speed and aperture value) on all pictures in the print order.
- Choose **Done** and press the **OK** button to complete the print order.

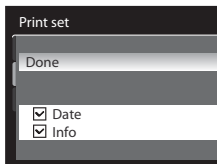

Pictures selected for printing are recognized by the  icon displayed with playback.

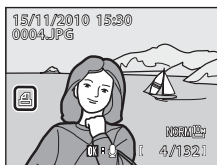

### Deleting All Print Orders

In step 1 of the print set procedure (📖123), choose **Delete print set** and press the **OK** button to delete the print orders for all pictures.

### More Information

See "Printing Images of Size 1:1" (📖72) for more information.

## ✓ Notes on Print Set

- When setting a print order in list by date mode and pictures other than those on the chosen date are already set for printing, the screen shown on the right is displayed.
  - Select **Yes** to add pictures taken on the selected shooting date, to the existing print order.
  - Select **No** to remove print marking from previously marked pictures and restrict the print order to pictures taken on the selected shooting date.

If the total number of the pictures in a print order exceeds 99, the screen shown on the right is displayed.

- Select **Yes** to remove pictures previously added from the print order and restrict the print order to pictures just marked.
- Select **Cancel** to remove the pictures just added from the print order and restrict the print order to pictures previously marked.

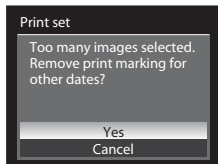
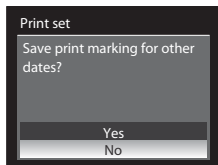

- NRW (RAW) pictures cannot be set for printing. Create a JPEG picture using **NRW (RAW) processing** (📖143), and then set the JPEG picture for printing.

## ✓ Notes on Printing Shooting Date and Photo Information

When the **Date** and **Info** options are enabled in the Print set menu, shooting date and photo information are printed on pictures when a DPOF-compatible (📖220) printer which supports printing of shooting date and photo information is used.

- Photo information cannot be printed when the camera is connected directly to a printer, via the supplied USB cable, for DPOF printing (📖166).
- Date** and **Info** are reset each time the **Print set** menu is displayed.
- The date and time printed on the picture is the date and time recorded on the camera when the picture was taken. The date and time printed using this option are not affected if the camera's **Date** setting is changed from the setup menu after the pictures are taken.



## 📷 Date imprint

The shooting date and time can be imprinted in pictures at the time of shooting by using **Date imprint** (📖174) in the setup menu. This information can be printed even from printers that do not support printing of the date and time. Only the date and time of Date imprint on the pictures are printed, even if **Print set** is enabled with the date selected in the print set screen.

## Slide Show

Press the **MENU** button →  (Playback menu) (📖123) →  Slide show

View pictures stored in the internal memory or on a memory card in an automatic slide show.

### 1 Use the rotary multi selector to choose **Start** and press the **OK** button.

- To change the interval between pictures, choose **Frame intvl**, select the desired interval time, and press the **OK** button before choosing **Start**.
- To repeat the slide show automatically, enable **Loop** and press the **OK** button before choosing **Start**. The check mark (✓) is added to the loop option when enabled.

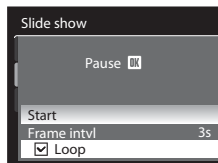

### 2 The slide show begins.

- Press the rotary multi selector **▶** to display the next picture, or **◀** to display the previous picture. Press and hold **▶** to fast forward, or **◀** to rewind.
- To exit partway or pause, press the **OK** button.



### 3 Choose End or Restart.

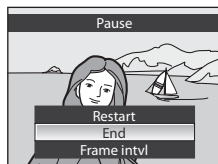

- When exiting or pausing the slide show, the screen shown on the right is displayed. Choose **End** and press the **OK** button to return to the playback menu. Choose **Restart** to play the slide show again.



### Notes on Slide Shows

- Only the first frame of movies (📖151) included in slide shows is displayed.
- Slide shows play for a maximum of 30 minutes, even when **Loop** is selected (📖181).

## Delete: Deleting Multiple Pictures

Press the **MENU** button →  (Playback menu)  (123) →  Delete

Delete a picture. Multiple pictures can also be deleted.

### Erase selected images

In the picture selection screen, choose the pictures for deletion. See “Selecting Pictures” ( 128) for more information.

- When images saved with an **Image quality** ( 68) setting of **NRW (RAW) + Fine**, **NRW (RAW) + Normal** or **NRW (RAW) + Basic** are chosen, the NRW (RAW) and JPEG images are deleted at the same time.

### Erase all images

Delete all pictures.

### Erase selected NRW images

Only NRW (RAW) pictures are displayed in the picture selection screen. Select and delete pictures.



- For pictures where NRW (RAW) and JPEG images are recorded at the same time, only the NRW (RAW) image is deleted.

### Erase selected JPEG images

Only JPEG pictures are displayed in the picture selection screen. Select and delete pictures.

- For pictures where NRW (RAW) and JPEG images are recorded at the same time, only the JPEG image is deleted.

## Notes on Deletion

- Once deleted, pictures cannot be recovered. Transfer important images to a computer before deletion.
- Pictures marked with the  icon are protected and cannot be deleted ( 129).
-  is displayed in the picture selection screen for pictures where NRW (RAW) and JPEG images are recorded at the same time.

## Selecting Pictures

The picture selection screen, as shown on the right, is displayed in the following menus.

Only one picture can be selected for some menu items, while for other menu items, multiple pictures can be selected.



Functions for which only one picture can be selected	Functions for which multiple pictures can be selected
<ul style="list-style-type: none"> <li>• <b>Playback menu:</b>                      Quick retouch* (📖135) ,                      D-Lighting* (📖136) ,                      Rotate image (📖130),                      Small picture* (📖137),                      Black border* (📖138),                      Skin softening* (📖139),                      Straighten* (📖141),                      Miniature effect* (📖142),                      NRW (RAW) processing (📖143)</li> <li>• <b>Setup menu:</b>  <b>Select an image</b> in Welcome screen (📖169)</li> </ul>	<ul style="list-style-type: none"> <li>• <b>Playback menu:</b>  <b>Select images</b> in Print set (📖123),                      Erase selected images in Delete (📖127),                      Protect (📖129),                      Hide image (📖130),  <b>Selected images</b> in Copy (📖131)</li> </ul>

\* These menus are displayed if menu items are selected when the playback menu has been displayed from a mode other than playback mode (📖13).

Follow the procedure described below to select pictures.

### 1 Rotate the rotary multi selector, or press ◀ or ▶ to choose the desired picture.

- Pictures can also be chosen by rotating the command dial.
- Rotate the zoom control to **T** (📖) to switch to full-frame playback, or **W** (📖) to switch to 12 thumbnails display.
- For functions for which only one picture is selected, proceed to step 3.



## 2 Press ▲ or ▼ to select ON or OFF (or the number of copies).

- When ON is selected, a check mark is displayed in the current picture. To set multiple pictures, repeat steps 1 and 2.



## 3 Press the OK button to apply the picture selection.

- With selections such as Erase selected images, the confirmation dialog is displayed. Follow the instructions on the screen.

## Protect

Press the MENU button → (Playback menu) (📖123) → Protect

Protect selected pictures from accidental deletion.

In the picture selection screen, choose a picture and set or cancel protection. See “Selecting Pictures” (📖128) for more information.

Note, however, that formatting the camera’s internal memory or the memory card permanently erases the protected files (📖182).

Protected pictures are recognized by the icon in playback mode (📖8, 117).

## Rotate Image

Press the **MENU** button →  (Playback menu) (📖123) →  Rotate image

Change the orientation of pictures played back in the camera's monitor after shooting. Still pictures can be rotated 90° clockwise or counterclockwise.

Pictures that were recorded in the "tall" (portrait) orientation can be rotated up to 180° in either direction.

Select a picture in the picture selection screen (📖128) to display the rotate image screen. Rotate the rotary multi selector, or press ◀ or ▶ to rotate the picture 90°.

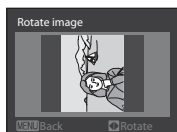

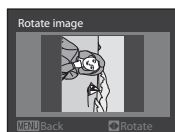
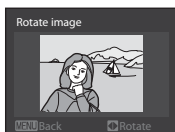

Rotate 90°  
counterclockwise



Rotate 90°  
clockwise

Press the **OK** button to set the orientation displayed and save the orientation data with the picture.

## Hide Image

Press the **MENU** button →  (Playback menu) (📖123) →  Hide image



Hide pictures so that they cannot be played back on the camera screen.

In the picture selection screen, choose the pictures and set or cancel the hide setting. See "Selecting Pictures" (📖128) for more information.

Hidden pictures cannot be deleted using the **Delete** option. Note, however, that formatting the internal memory or memory card (📖182) permanently erases the hidden pictures.





## Copy: Copying Between the Internal Memory and Memory Card

Press the **MENU** button →  (Playback menu) (📖123) →  Copy

Copy pictures between the internal memory and a memory card.

- 1 Use the rotary multi selector to select an option from the copy screen and press the  button.

- : Copy pictures from the internal memory to the memory card.
- : Copy pictures from the memory card to the internal memory.

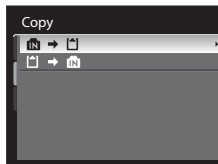

- 2 Select a copy option and press the  button.

- **Selected images:** In the picture selection screen (📖128), choose the pictures for copying.
- **All images:** Copy all pictures.

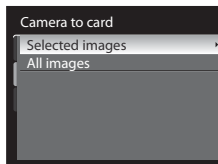

### Notes on Copying Pictures

- JPEG-, NRW-, MOV-, and WAV-format files can be copied. Files recorded in any other format cannot be copied.
- If voice memos (📖132) are attached to pictures selected for copying, voice memos are copied with the pictures.
- When images saved with an **Image quality** (📖68) setting of **NRW (RAW) + Fine**, **NRW (RAW) + Normal** or **NRW (RAW) + Basic** are chosen, the NRW (RAW) and JPEG images are copied at the same time.
- Pictures recorded with another make or model of camera or that have been modified on a computer cannot be copied.
- When pictures with **Print set** (📖123) settings are copied, the print set settings are not copied. When pictures with **Protect** (📖129) settings are copied, the copied pictures are also protected.
- Pictures with **Hide image** (📖130) settings cannot be copied.



### Message: “Memory contains no images.”

If there are no pictures stored on the memory card when playback mode is selected, the message, **Memory contains no images.**, is displayed. Press the **MENU** button to display the copy option screen, and copy the pictures stored in the camera's internal memory to the memory card.

### More Information

See “File and Folder Names” (📖203) for more information.

## Voice Memos: Recording and Playback

Use the built-in or external microphone to record voice memos for pictures marked with   in full-frame playback mode ( 30).



### Recording Voice Memos

A voice memo, up to 20 seconds in length, is recorded while the  button is pressed down.

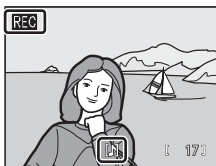
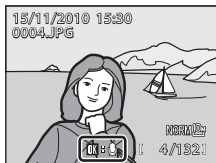
- Do not touch the microphone during recording.
- During recording, **REC** and  blink on the monitor.





### Playing Voice Memos

Pictures with recorded voice memos can be recognized by the   icon in the full-frame playback mode. Display a recorded picture in the full-frame playback mode, and press the  button.

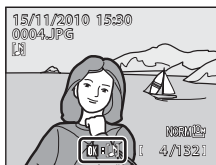
- Use the zoom control **T** or **W** during playback to adjust the volume.
- Press the  button again during playback to end the playback.



### Deleting Voice Memos

Choose a picture with a voice memo and press the  button. Use the rotary multi selector to choose  and press the  button. Only the voice memo is deleted.

#### Notes on Voice Memos

- When a picture with a voice memo attached is deleted, both the picture and its voice memo are deleted.
- Voice memos cannot be recorded for a picture that already has a voice memo attached. The current voice memo must be deleted before a new voice memo can be recorded.
- Voice memos cannot be attached to pictures shot with cameras other than the COOLPIX P7000.

#### More Information

See "File and Folder Names" ( 203) for more information.

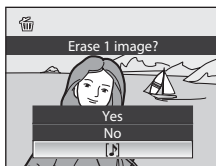

## Picture Editing Functions

Images can be easily edited with this camera using the functions below. Edited images are stored as separate files (📖203).

Editing function	Application
Quick retouch (📖135)	Easily create a copy with enhanced contrast and richer colors.
D-Lighting (📖136)	Create a copy of the current picture with enhanced brightness and contrast, brightening dark portions of the picture.
Small picture (📖137)	Create a small copy of pictures suitable for uses such as e-mail attachments.
Black border (📖138)	Add a black frame around the picture. Use when you want to add a black border to a picture.
Skin softening (📖139)	Make the subject's skin appear smoother.
Straighten (📖141)	Compensate for the slanting.
Miniature effect (📖142)	Create a copy that appears to be a photo of a diorama.
NRW (RAW) processing (📖143)	Create JPEG-format copies by performing RAW processing within the camera for NRW (RAW) images without having to use a computer.
Crop (📖145)	Crop picture. Enlarge the image or refine the composition and create a copy containing only the portion visible on the monitor.

### ✔ Notes on Picture Editing

- Pictures shot with an **Image size** (📖70) of  $3648 \times 2432$ ,  $3584 \times 2016$ , and  $2736 \times 2736$  can only be modified using the Black border editing function.
- When no faces can be detected in the picture, skin softening cannot be applied (📖139).
- Editing other than NRW (RAW) processing cannot be performed on NRW (RAW) images. Edit a JPEG picture created with NRW (RAW) processing.
- The COOLPIX P7000's editing functions are not available for pictures shot with digital cameras other than the COOLPIX P7000.
- If a copy created using the COOLPIX P7000 is viewed on a different digital camera, it may not be possible to display the picture properly or transfer it to a computer.
- Editing functions are not available when there is not enough free space in the internal memory or on the memory card.

### Restrictions on Picture Editing

The following limitations apply when editing pictures that were created by editing.

Copies Created By:	Can Be Edited By:
Quick retouch D-Lighting	Skin softening, Small picture, or crop can be used. Quick retouch and D-Lighting cannot be used together.
Small picture Straighten Miniature effect Crop	No additional editing functions can be used.
Skin softening	Quick retouch, D-Lighting, Small picture or crop can be used.
Black border	No additional editing functions can be used. A black border cannot be added to a picture created with a different editing function.
NRW (RAW) processing	Additional editing functions can be used.

- Copies created by editing cannot be edited again using the same edit function.
- To use an editing function together with small picture or crop, use the other edit function first, and use small picture or crop as the last edit function performed on that picture.
- Pictures that were taken using skin softening can be edited using skin softening.

### Original Pictures and Edited Copies



- Copies created with editing functions are not deleted if the original pictures are deleted. The original pictures are not deleted if copies created with editing functions are deleted.
- Edited copies are stored with the same recording date and time as the original.
- Even if the pictures that are marked for **Print set** (📖123) or **Protect** (📖129) are used for editing, these settings are not reflected on the edited copies.

## Editing Pictures

### **Quick Retouch: Enhancing Contrast and Saturation**

Easily create retouched images in which contrast and saturation have been enhanced. Retouched copies are stored as separate files.

- 1 Choose the desired picture from full-frame (30) or thumbnail (116) playback mode and press the **MENU** button.

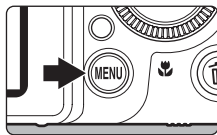

- Switch to the  tab when the playback menu is not displayed (14).

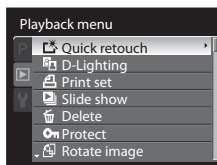

- 2 Use the rotary multi selector to choose  **Quick retouch** and press the **OK** button.

- The original version is shown on the left and the edited version is shown on the right.



- 3 Press  or  to choose the setting level, and press the **OK** button.

- A retouched copy is created.
- To cancel, press the **MENU** button.

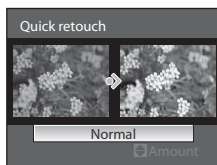

- Quick retouched copies can be recognized by the  icon displayed during playback.

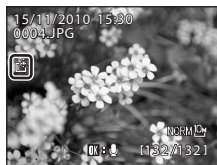



### **More Information**

See "File and Folder Names" (203) for more information.

## D-Lighting: Enhancing Brightness and Contrast

Create copies with enhanced brightness and contrast, brightening dark portions of a picture. Enhanced copies are stored as separate files.

- 1 Choose the desired picture from full-frame () or thumbnail () playback mode and press the **MENU** button.

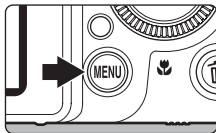

- Switch to the  tab when the playback menu is not displayed ()14).

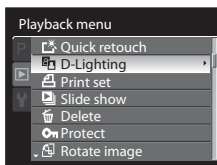

- 2 Use the rotary multi selector to choose  **D-Lighting** and press the **OK** button.

- The original version is shown on the left and the edited version is shown on the right.



- 3 Press  or  to choose the setting level, and press the **OK** button.

- A new, edited copy is created.
- To cancel, press the **MENU** button.

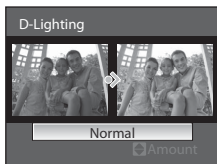





- D-Lighting copies can be recognized by the  icon displayed during playback.





### More Information

## **Small Picture: Resizing Pictures**

Create a small copy of the picture taken. Suitable for displaying on web pages or sending as e-mail attachments. The available size is  **640×480**,  **320×240** or  **160×120**. Small copies are stored as separate files with a compression ratio of 1:16.

- 1 Choose the desired picture from full-frame (30) or thumbnail (116) playback mode and press the **MENU** button.

- Switch to the  tab when the playback menu is not displayed (14).

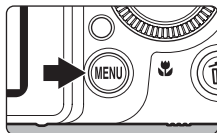

- 2 Use the rotary multi selector to choose  **Small picture** and press the **OK** button.

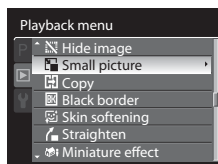

- 3 Choose the desired copy size and press the **OK** button.

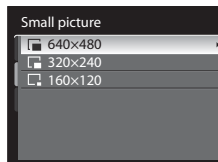

- 4 Choose **Yes** and press the **OK** button.

- A new, smaller copy is created.
- To cancel, choose **No** and press the **OK** button.
- The copy is displayed with a gray frame.

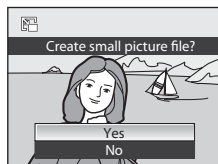

## **More Information**

See "File and Folder Names" (203) for more information.

## **BK** Black Border: Adding a Black Border to Pictures

This function creates black borders along the border of a picture. Choose from **Thin**, **Medium**, or **Broad** lines. The created pictures are stored as separate files.

- 1 Choose the desired picture from full-frame (📖30) or thumbnail (📖116) playback mode and press the **MENU** button.

- Switch to the **▶** tab when the playback menu is not displayed (📖14).

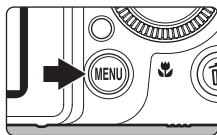

- 2 Use the rotary multi selector to choose **BK Black border** and press the **OK** button.

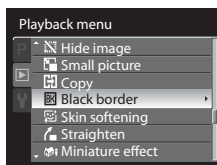

- 3 Choose the desired frame thickness and press the **OK** button.

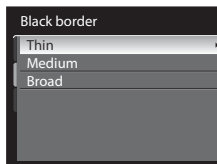

- 4 Choose **Yes** and press the **OK** button.

- A new copy with a black border is created.
- To cancel, choose **No** and press the **OK** button.
- Copies created by editing with black borders can be recognized by the **BK** icon displayed during playback.



### **✓** Black Border

- A part of the picture equivalent to the thickness of the black border is cut off because the black border overlaps the picture.
- When a picture with a black border is printed using a printer's borderless print function, the black border may not be printed.

### **🔍** More Information



See "File and Folder Names" (📖203) for more information.





## Skin Softening: Making Skin Appear Smoother

Skin softening can be applied to faces that are detected in pictures already taken, to make skin appear smoother. Pictures edited with this function are stored as separate files.

- 1 Choose the desired picture from full-frame ()30) or thumbnail ()116) playback mode and press the **MENU** button.

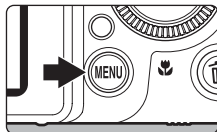
- Switch to the  tab when the playback menu is not displayed (14).



- 2 Use the rotary multi selector to choose  **Skin softening** and press the **OK** button.

- The screen that allows you to set the amount of skin softening appears.
- If no faces can be detected in the image, a warning is displayed and the screen returns to the playback menu.

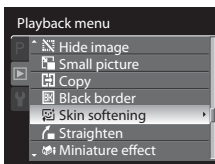

- 3 Press **▲** or **▼** to choose the setting level, and press the **OK** button.

- A confirmation screen is displayed, and the image is displayed zoomed in on the face edited by skin softening.
- To cancel, press the **MENU** button.

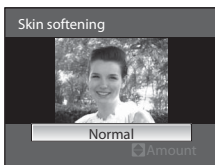

### 4 Confirm the results.

- Up to 12 faces, in order of proximity to the center of the frame, can be enhanced.
- When multiple faces are edited using skin softening, use the rotary multi selector ◀ and ▶ to switch the face that is displayed.
- To adjust the extent of skin softening, press the **MENU** button and return to step 3.
- To create a copy edited with skin softening, press the **OK** button.
- Copies created by editing with skin softening can be recognized by the  icon displayed during playback.

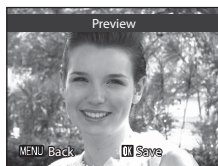

### **Note on Skin Softening**

Depending on conditions such as the direction the subject is facing or the brightness of the face, the face may not be detected properly, or the desired effect may not be achieved.



### **More Information**

See "File and Folder Names" ( 203) for more information.

## Straighten: Compensating for Picture Slanting

Compensate for the slanting of shot pictures. Pictures edited with this function are stored as separate files.

- 1 Choose the desired picture from full-frame ()30) or thumbnail ()116) playback mode and press the **MENU** button.

- Switch to the  tab when the playback menu is not displayed ()14).

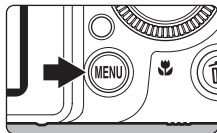

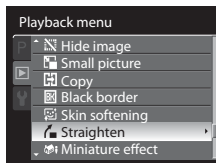

- 2 Use the rotary multi selector to choose  **Straighten** and press the **OK** button.

- The straighten screen is displayed.



- 3 Compensate for slanting.

- Press  to rotate counterclockwise by 1 degree.
- Press  to rotate clockwise by 1 degree.
- To cancel, press the **MENU** button.
- To create a copy edited with straighten, press the **OK** button.
- Copies created by editing with straighten can be recognized by the  icon displayed during playback.

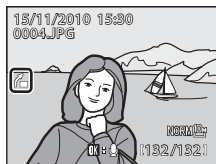

### Notes on Straighten

- When straighten is performed, the picture edges are cut. The larger the slant for which compensation is performed, the larger the area around the picture that is cut.
- Straighten can be performed up to 15 degrees.



### More Information

See "File and Folder Names" ()203) for more information.

## Miniature Effect: Setting Close-up Miniature Effects

Create a copy that appears to be a photo of a diorama. Pictures taken while looking down from a high location and with the main subject near the center of the screen are suitable for the miniature effect. Pictures edited with this function are stored as separate files.

- 1 Choose the desired picture from full-frame (30) or thumbnail (116) playback mode and press the **MENU** button.

- Switch to the  tab when the playback menu is not displayed (14).

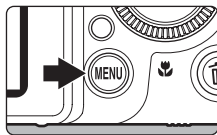

- 2 Use the rotary multi selector to choose  **Miniature effect** and press the **OK** button.

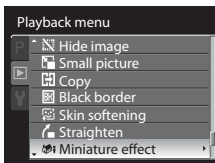

- 3 Choose **OK** and press **OK** button.

- A confirmation screen is displayed.
- To cancel, choose **Cancel** and press the **OK** button.



- 4 Check the effect and press the **OK** button.

- A copy is created with the miniature effect applied.
- To cancel, press the **MENU** button.
- Copies created by editing with miniature effect can be recognized by the  icon displayed during playback.



## More Information

See "File and Folder Names" (203) for more information.

## NRW NRW (RAW) Processing: Creating JPEG Images from NRW Images

Create JPEG-format copies by performing RAW processing within the camera for NRW (RAW) images saved with an **Image quality** (📖68) setting of **NRW (RAW)**, **NRW (RAW) + Fine**, **NRW (RAW) + Normal** or **NRW (RAW) + Basic**.

- 1 Press the **MENU** button in playback mode.
  - Switch to the ▶ tab when the playback menu is not displayed (📖14).

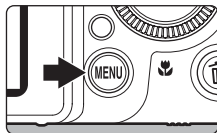

- 2 Use the rotary multi selector to choose **NRW NRW (RAW) processing** and press the **OK** button.

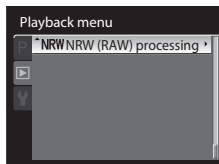

- 3 Rotate the rotary multi selector or press ◀ or ▶ to choose the picture to be RAW processed and press the **OK** button.
  - The NRW (RAW) processing menu is displayed.

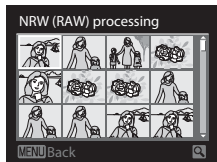

## 4 Set the NRW (RAW) processing parameters.

- Apply the settings below while checking the image and rotating the zoom control to **T** (Q). Rotate to **T** (Q) again to return to the setting screen.
  - **White balance:** Choose a white balance setting (📖76).
  - **Exp. +/-:** Adjust the brightness.
  - **Picture Control:** Choose an image processing setting (📖92).
  - **Image quality:** Choose the image quality from **Fine**, **Normal**, or **Basic** (📖68).
  - **Image size:** Choose an image size (📖70). The image is cropped if **3648x2432**, **3584x2016** or **2736x2736** is selected.
  - **Distortion control:** Set the distortion control (📖104).
  - **D-Lighting:** Enhance brightness and contrast in dark portions of pictures (📖136).
- Press the **🗑** button to change back to the default settings.
- Choose **EXE** when all settings have been adjusted.

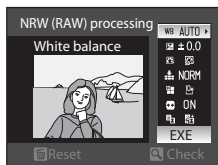

## 5 Choose **Yes** and press the **OK** button.

- An NRW (RAW) processed JPEG image is created.
- To cancel the creation, choose **No**.

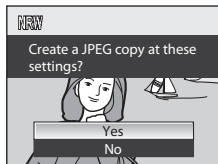

### ✓ Notes on NRW (RAW) Processing

- The COOLPIX P7000 can only create JPEG-format copies of NRW (RAW) images taken with the COOLPIX P7000.
- NRW (RAW) processing > **White balance** > **Preset manual** cannot be selected for photographs taken at a **White balance** setting other than **Preset manual**.

### 📖 More Information

- See "Printing Images of Size 1:1" (📖72) for more information.
- See "File and Folder Names" (📖203) for more information.

## ✂ Crop: Cropping Pictures





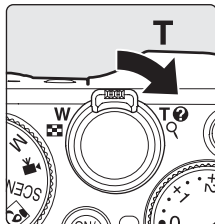

Create a copy containing only the portion visible on the monitor when **MENU**  is displayed with playback zoom ( 118) enabled. Cropped copies are stored as separate files.

### 1 Rotate the zoom control to **T** () in full-frame playback mode ( 30) to zoom in on the picture.

- To crop a picture displayed in “tall” (portrait) orientation, zoom in on the picture until the black bars displayed on the both sides of the monitor disappear. The cropped picture is displayed in landscape orientation. To crop the picture in its current “tall” (portrait) orientation, first, use the **Rotate image** option ( 130) to rotate the picture so that it is displayed in landscape orientation. Next, enlarge the picture for cropping, crop the picture, and then rotate the cropped picture back to “tall” (portrait) orientation.



### 2 Refine copy composition.

- Rotate the zoom control to **T** () or **W** () to adjust the zoom ratio.
- Press the rotary multi selector , , , or  to scroll the picture until only the portion you want to copy is visible on the monitor.



### 3 Press the **MENU** button.

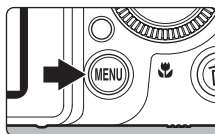

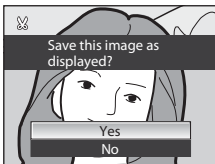

### 4 Use the rotary multi selector to choose **Yes** and press the **OK** button.

- A new picture, containing only the portion visible on the monitor, is created.
- To cancel, choose **No** and press the **OK** button.



### Image Size

The smaller the cropping range, the smaller the size (amount of pixels) of the cropped picture copy. When the image size setting for a cropped copy is 320x240 or 160x120, a gray frame appears around the picture during playback, and the  or  small picture icon appears on the left side of the monitor.

### More Information

See “File and Folder Names” ( 203) for more information.

## Recording Movies

High-definition movies can be shot with sound.

- Regardless of the remaining memory on the memory card, the maximum length for a single movie is 29 minutes.

### 1 Rotate the mode dial to .

- The monitor shows the amount of available recording time.

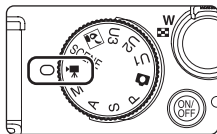

### 2 Press the shutter-release button all the way down to start recording.

- The camera focuses in the center focus area. The focus area is not displayed when the movie is recorded.
- When shooting high-definition or full high-definition movies, the aspect ratio of the shooting screen is switched to 16:9 (The movie is recorded in the range shown in the screen on the right).
- The monitor shows the amount of recording time remaining. Recording stops automatically when the recording time runs out.



### 3 Press the shutter-release button all the way down to end recording.

#### Note on Recording Movies

When the AF lamp blinks after shooting, the movie is being saved. **Do not open the battery-chamber/memory card slot cover.** Cutting the power or removing the memory card before saving is complete could result in loss of data or in damage to the camera or card.

#### External Microphones

Instead of the built-in microphone, a commercially available microphone can be connected to the external microphone connector (📖5) to record sound during movie recording or voice memos for still pictures (📖132). Use an external microphone that conforms to the specifications of “External microphone connector” in “I/O terminal” (📖218) in “Specifications.”

- When the external microphone is connected, **Wind noise reduction** (📖150) in the movie menu cannot be used.



## ✓ Notes on Movie Recording

- When recording a movie onto a memory card, a memory card with an SD speed class of Class 6 or higher is recommended (📖221). If the transfer speed of the card is slow, the movie recording may end unexpectedly.
- Using a digital zoom causes image quality to deteriorate. If you start recording the movie without using digital zoom, and you rotate the zoom control in the **T** direction, the zoom stops at the maximum optical zoom ratio. Release the zoom control and rotate it again in the **T** direction to trigger digital zoom.
- The sound of using the zoom control, zoom, autofocus, vibration reduction or aperture control when the brightness changes may be recorded. To minimize the recording of the zoom sound, set **Zoom speed** in the setup menu to **Auto** (default setting) or **Quiet** (📖179).
- Smear (📖198) visible in the monitor when recording movies will be recorded with the movies. Avoiding bright objects such as the sun, reflections of the sun, and electric lights when recording movies is recommended.

## ✓ Notes on Autofocus

- When **Autofocus mode** in the movie menu is set to **AF Single AF** (default setting), the focus is locked when the shutter-release button is pressed halfway (📖150).
- Autofocus may not perform as expected (📖29). Should this occur, try the following:
  1. Before recording, set **Autofocus mode** in the movie menu to **AF Single AF** (default setting).
  2. Position a different subject at the same distance in the middle of the screen. Press the shutter-release button to start the movie recording, and change the composition.

## ✓ Notes on the Camera Temperature



When functions such as movie recording are used for a long time, or when the camera is used in a location with a high ambient temperature, the camera temperature may rise. This is not a malfunction.

## 📎 Functions Available in Movie Recording

- Exposure compensation (📖43) can be adjusted. **AF** (Autofocus), **🌸** (Macro close-up) or **▲** (Infinity) can be selected for focus mode (📖40).
- Quick-response remote in the remote control mode (📖38) is available. Self-timer and Smile timer cannot be used.
- Flash does not fire.
- Rotate the quick menu dial to **QUAL** or **WB** and press the quick menu button to set **Movie options** (📖148) or **White balance** (📖76).
- Press the **MENU** button before starting to record the movie to display the **🎬** (movie) tab and select movie menu settings (📖149).
- Settings cannot be changed during movie recording. Before movie recording, check the settings.

## Selecting a Movie Type to Shoot

You can choose the type of movie to shoot. The higher the resolution and bitrate, the higher the picture quality; but the file size also becomes larger.

Option	Description
 <b>HD 720p (1280×720)</b> (default setting)	Movies with an aspect ratio of 16:9 are recorded in high-definition. This option is suited to playback on a wide screen TV. <ul style="list-style-type: none"> <li>Image size: 1280×720 pixels</li> <li>Movie bitrate: 9 Mbps</li> </ul>
 <b>VGA (640×480)</b>	Movies with an aspect ratio of 4:3 are recorded. <ul style="list-style-type: none"> <li>Image size: 640×480 pixels</li> <li>Movie bitrate: 3 Mbps</li> </ul>
 <b>QVGA (320×240)</b>	Movies with an aspect ratio of 4:3 are recorded. <ul style="list-style-type: none"> <li>Image size: 320×240 pixels</li> <li>Movie bitrate: 640 kbps</li> </ul>

- The movie bitrate is the volume of movie data recorded per second. As a variable bitrate (VBR) system has been adopted, the movie recording rate varies automatically according to the subject so that more data is recorded per second for movies containing frequently moving subjects, thus increasing movie file size.
- The frame rates are approximately 24 frames per second (fps) for **HD 720p (1280×720)** and 30 frames per second (fps) for **VGA (640×480)** or **QVGA (320×240)**.

## Setting the Movie Options

- Rotate the quick menu dial to **QUAL** and press the quick menu button.

- The quick menu is displayed.
- Rotate the mode dial (📖44) to .

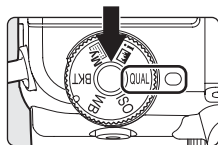

- Choose the movie type with the command dial.

- The maximum movie length for the selected movie type is displayed.

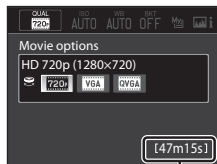



Maximum movie length

- After completing the settings, press the quick menu button.

- The monitor display reverts to shooting mode.

## Maximum Movie Length

Option	Internal memory (79 MB)	Memory card (4 GB)*
 HD 720p (1280×720) (default setting)	1 min 10 s	55 min
 VGA (640×480)	3 min 22 s	2 h 30 min
 QVGA (320×240)	13 min 57 s	11 h

All figures are approximate. The maximum movie length varies with the make of the memory card and the bitrate of the shot movie.

\* The maximum recording time for a single movie is 29 minutes. The maximum movie length displayed during recording is 29 minutes, even when there is enough free space on the memory card for a longer movie.

## More Information

See "File and Folder Names" ( 203) for more information.

## Changing the Movie Mode Settings

The options below can be set in the movie menu.

### Autofocus mode

 150

Choose how the camera focuses when recording movies.



### Wind noise reduction

 150

Set whether or not to reduce wind noise during movie recording.

## Displaying the Movie Menu

Rotate the mode dial to  (movie).

Press the **MENU** button to display the menu, use the rotary multi selector to change to the  tab and display the movie menu ( 14).

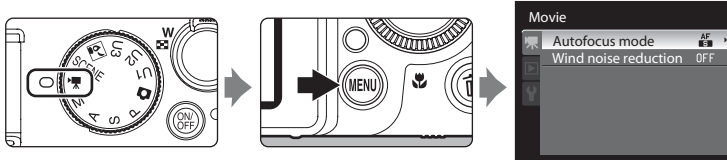



- Use the rotary multi selector to select items and set functions on the menu ( 12).
- Press the **MENU** button to exit the movie menu.

## Autofocus Mode

Set to  (Movie) → MENU →  (Movie menu) (📖149) → Autofocus mode

Choose how the camera focuses when recording movies.

Option	Description
 <b>Single AF</b> (default setting)	Locks on the focus when the shutter-release button is pressed halfway. Select this option when the distance between the camera and the subject remains fairly consistent.
 <b>Full-time AF</b>	The camera focuses continuously during movie recording. Suitable for shooting when the distance between the camera and subject changes. The operation sound when the camera focuses may be recorded. Setting to <b>Single AF</b> is recommended if the sound is noticeable.

## Wind Noise Reduction

Set to  (Movie) → MENU →  (Movie menu) (📖149) → Wind noise reduction

Set whether or not to reduce wind noise during movie recording.

Option	Description
 <b>On</b>	Records while minimizing the noise of wind blowing on the camera's built-in microphone. Suitable for recording in strong winds. During playback, not only wind noise, but other sounds may also become difficult to hear.
<b>OFF Off</b> (default setting)	Wind noise is not reduced.

When the wind noise reduction setting is enabled, the current setting is displayed during shooting (📖6). When **Off** is selected, an icon for the current setting is not displayed.

### Note on Wind Noise Reduction

When the external microphone (📖146) is used for shooting, **Wind noise reduction** is not available.

## Movie Playback

In full-frame playback mode (📖30), movies can be recognized by a movie options icon (📖148). To play a movie, press the **OK** button.

Use the zoom control **T** or **W** during playback to adjust the volume. Playback controls appear at the top of the monitor. Press the rotary multi selector ◀ or ▶ to choose a playback control, then press the **OK** button to perform the selected operation. The following operations are available.



During playback

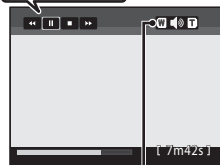

During  
playback

Volume  
indicator

To	Use	Description	
Rewind	⏮	Rewind the movie while the <b>OK</b> button is pressed down.	
Advance	⏭	Advance the movie while the <b>OK</b> button is pressed down.	
Pause	⏸	The following operations can be performed with the playback controls at the top of the monitor while playback is paused.	
		⏮	Rewind the movie by one frame. Hold down the <b>OK</b> button to rewind continuously.*
		⏭	Advance the movie by one frame. Hold down the <b>OK</b> button to advance continuously.*
		✂	Extract and save only the required parts of the movie (📖152).
		🖼	Save the extracted frame from a movie as a still picture (📖153).
	▶	Resume playback.	
End	⏹	Return to full-frame playback mode.	

\* The movie can also be advanced or rewound by one frame by rotating the rotary multi selector or command dial.

### ✔ Note on Movie Playback

Movies shot with cameras other than COOLPIX P7000 cannot be played back.

## Editing Movies

You can extract only the required parts of a movie and save as a separate file.

**1** Play back and pause the movie that you want to edit (📖151).

**2** Use the rotary multi selector ◀ or ▶ to choose  on the playback control and press the **OK** button.

- The movie editing screen is displayed.

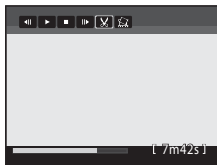

**3** Press ▲ or ▼ to choose  (Choose start point) on the editing playback control.

- Rotate the rotary multi selector or press ◀ or ▶ to move the start point at the left end to the start position of the required section.
- To cancel, press ▲ or ▼ to choose  (Back) and press the **OK** button.

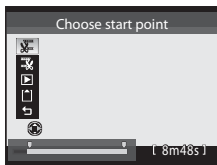

**4** Press ▲ or ▼ to choose  (Choose end point).

- Rotate the rotary multi selector or press ◀ or ▶ to move the end point at the right end to the end position of the required section.
- To check the playback of the movie in the specified range before saving it, choose  (Preview) and press the **OK** button. During preview playback, the volume can be adjusted with the zoom control **T/W**. Use the rotary multi selector to fast forward or rewind. To stop the preview playback, press the **OK** button.

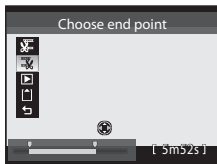

**5** After finishing the settings, press ▲ or ▼ to choose  (Save) and press the **OK** button.

**6** Choose **Yes** and press the **OK** button.

- The edited movie is saved.
- To cancel the saving, choose **No**.

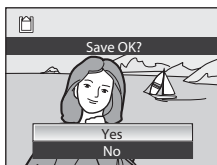

## ✓ Notes on Editing Movies

- Once a movie is created through editing, it cannot be used again for extracting a movie. To extract another range, select and edit the original movie.
- Because the edited movies are extracted in 1-second units, they may vary slightly from the set start point and end point. Sections shorter than two seconds cannot be extracted.
- Editing functions are not available when there is not enough free space in the internal memory or on the memory card.

## 🔍 More Information

See "File and Folder Names" (📖203) for more information.



## Saving a Frame from a Movie as a Still Picture

A screen from a shot movie can be extracted and saved as a still picture.

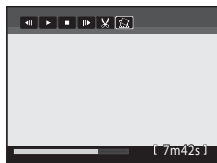

- Pause a movie and display the screen to be extracted (📖151).
- Choose  on the playback control with the rotary multi selector ◀ or ▶ and press the **OK** button.



- When the confirmation dialog is displayed, choose **Yes** and press the **OK** button to save. To cancel the saving, choose **No**.
- The still picture is saved with **Normal** as the image quality. The image size is determined by the type (resolution) (📖148) of the original movie.

-  HD 720p (1280×720) →  1280×720

-  VGA (640×480) →  640×480

-  QVGA (320×240) →  320×240

- When the picture is saved with , it is displayed with a gray frame during playback.

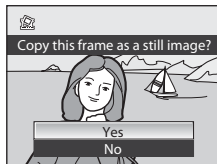

## Deleting Unnecessary Movies

Press the  button when a movie is selected in full-frame playback mode (📖30) or thumbnail playback mode (📖116) to display the confirmation dialog for deletion.

Select **Yes** and press the **OK** button to delete the movie, or select **No** to exit without deleting the movie.

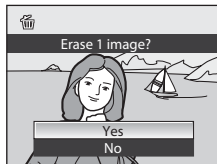

## Connecting to a TV

Connect the camera to a television to play back pictures on the television. If your television is equipped with an HDMI connector, you can connect it to the camera with a commercially available HDMI cable to enjoy recorded movies in the high-definition quality.

### 1 Turn off the camera.

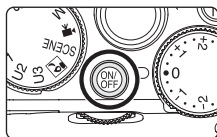

### 2 Connect the camera to the TV.

#### When connecting using the supplied audio/video cable

- Connect the yellow plug to the video-in jack on the TV, and the red and white plugs to the audio-in jacks.

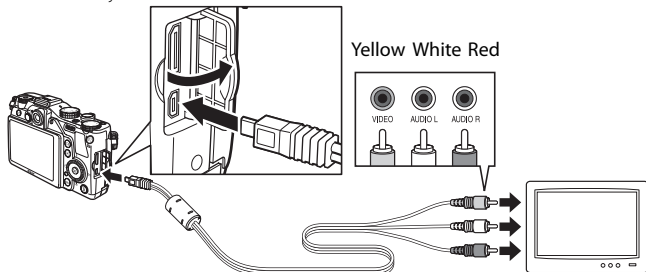

#### When connecting using a commercially available HDMI cable

- Connect the plug to the HDMI jack on the TV.

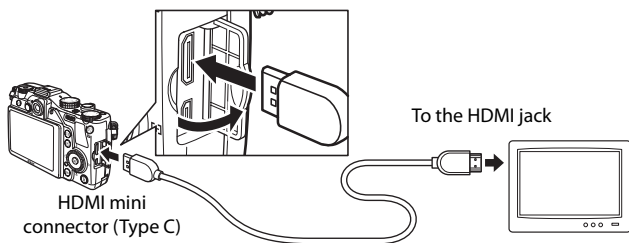



### 3 Tune the television to the video channel.



- See the documentation provided with your television for details.

### 4 Hold down the button to turn on the camera.

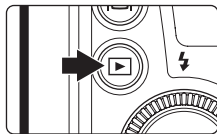
- The camera enters playback mode, and the recorded pictures are displayed on the television.
- While the camera is connected to the TV, the monitor remains off.



#### Notes on Connecting an HDMI Cable

- An HDMI cable is not supplied. Use a commercially available HDMI cable to connect the camera to a TV. The output terminal on this camera is a HDMI Mini Connector (Type C). When purchasing an HDMI cable, be sure that the device end of the cable is a HDMI Mini Connector.
- To enjoy playback in high-definition quality when the camera is connected to a television that has an HDMI connector, we recommend shooting still pictures with **Image size** set to  **2048x1536** or higher, and recording movies with **Movie options** set to  **HD 720p (1280x720)**.

#### Notes on Connecting the Audio/Video Cable

- When connecting the cable, be sure that the connector is oriented correctly. Do not force the connector into the camera. When disconnecting the cable, do not pull the connector at an angle.
- Do not connect an audio/video cable and HDMI cable to the camera at the same time.
- Do not connect an HDMI cable and USB cable to the camera at the same time.

#### When Nothing Appears on the TV

Make sure that **TV settings** ( 183) in the setup menu ( 167) is appropriate for your television.

## Connecting to a Computer

Use the supplied USB cable to connect the camera to a computer and copy (transfer) images to the computer.

### Before Connecting the Camera

#### Install the Software

Use the supplied ViewNX 2 CD and install the following software on the computer.

- ViewNX 2: Use the image transfer feature “Nikon Transfer 2” to save images that were captured with the camera on the computer. Saved images can be viewed and printed. Image and movie editing features are also supported.
- Panorama Maker 5: This software can join a series of images to create a single panorama image.

For more information on installing the software, refer to the *Quick Start Guide*.

#### Compatible Operating Systems

##### Windows

Windows 7 Home Basic/Home Premium/Professional/Enterprise/Ultimate, Windows Vista Home Basic/Home Premium/Business/Enterprise/Ultimate (Service Pack 2), or Windows XP Home Edition/Professional (Service Pack 3)

##### Macintosh

Mac OS X (version 10.4.11, 10.5.8, 10.6.4)

For information on the requirements for playing back high-definition movies, refer to “System Requirements” in the ViewNX 2 help information (📖160).

Refer to the Nikon website for the latest information on operating system compatibility.

#### Notes on Power Source

- When connecting the camera to a computer to transfer images, use a fully charged battery to prevent the camera from turning off unexpectedly.
- If the AC Adapter EH-5a and the Power Connector EP-5A (available separately) are used, COOLPIX P7000 can be powered from an electrical outlet. Do not, under any circumstances, use an AC Adapter other than the EH-5a or a Power Connector other than the EP-5A.

## Transferring Images from a Camera to a Computer

- 1 Start the computer to which ViewNX 2 was installed.
- 2 Be sure that the camera is off.
- 3 Connect the camera to the computer using the supplied USB cable.

Be sure that connectors are properly oriented. Do not attempt to insert connectors at an angle, and do not use force when connecting or disconnecting the USB cable.

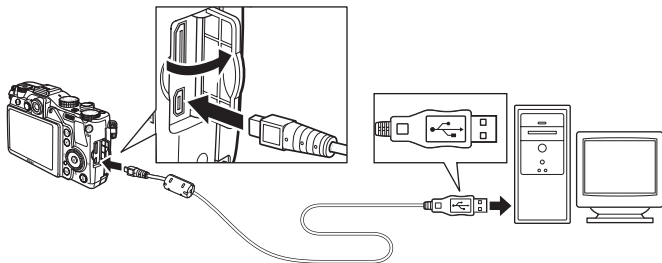

- 4 Turn on the camera.
  - The power-on lamp lights. The camera monitor remains off.

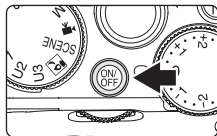

### ✓ Connecting the USB Cable

The connection may not be recognized if the camera is connected to the computer via a USB hub.

## 5 Start the ViewNX 2 image transfer feature “Nikon Transfer 2” installed on the computer.

- **Windows 7**

When the **Devices and Printers ► P7000** screen is displayed, click **Change program** under **Import pictures and videos**. Select **Import File using Nikon Transfer 2** in the **Change program** dialog and click **OK**.

Double-click **Import File** on the **Devices and Printers ► P7000** screen.

- **Windows Vista**

When the **AutoPlay** dialog is displayed, click **Import File using Nikon Transfer 2**.

- **Windows XP**

When the action selection dialog is displayed, select **Nikon Transfer 2 Import File** and click **OK**.

- **Mac OS X**

Nikon Transfer 2 will start automatically when the camera is connected to the computer if **Yes** was selected in the **Auto-Launch setting** dialog when Nikon Transfer 2 was first installed.

- If charge for the battery inserted into the camera is low, the computer may not recognize the camera. If the camera is not recognized, images will not be transferred.
- If there are a large number of images on the memory card, it may take some time for Nikon Transfer 2 to start.

- 6** Confirm that the source device is displayed in the transfer options **Source** panel and click **Start Transfer**.

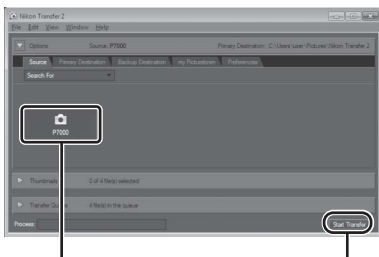

**Source device**

**Start Transfer button**

Any images that have not been transferred to the computer will be transferred (default setting of ViewNX 2).

ViewNX 2 starts automatically when the transfer is complete (default setting of ViewNX 2). Transferred images can be viewed.



For more information on using ViewNX 2, refer to the ViewNX 2 help information (📖160).

## Disconnecting the Camera

Do not turn off the camera or disconnect the camera from the computer during transfer.

When transfer is complete, turn off the camera and disconnect the USB cable.

### **Transferring Images Using a Computer's Card Slot or a Commercially-available Card Reader**

When the memory card is inserted into a computer's card slot or into a commercially-available card reader, the images can be transferred using "Nikon Transfer 2", the image transfer feature of ViewNX 2.

- Make sure that the memory card being used is supported by the card reader or other card reading device.
- To transfer images, insert the memory card into the card reader or card slot and follow the procedure from step 5 (📖158).
- To transfer images saved in the camera's internal memory, the images must first be copied to a memory card using the camera (📖131).

### **Starting ViewNX 2 or Nikon Transfer 2 Manually**

#### **Windows**

Choose **Start** menu → **All Programs** → **ViewNX 2** → **ViewNX 2**.

Double-clicking the **ViewNX 2** shortcut icon on the desktop will also start ViewNX 2.

#### **Mac OS X**

Open the **Applications** folder, open the **Nikon Software** → **ViewNX 2** folders in that order, and then double-click the **ViewNX 2** icon. Clicking the **ViewNX 2** icon on the Dock will also start ViewNX 2.

Click **Transfer** in the ViewNX 2 screen to start Nikon Transfer 2.

### **Viewing ViewNX 2 Help Information**

For more information on ViewNX 2 or Nikon Transfer 2, start ViewNX 2 or Nikon Transfer 2 and select **ViewNX 2 Help** from the **Help** menu.

### **Panorama Creation with Panorama Maker 5**

- Use a series of images captured in **Panorama assist** scene mode (📖55) to create a single panorama photo with Panorama Maker 5.
- Panorama Maker 5 can be installed on a computer using the supplied ViewNX 2 CD.
- After installation is complete, follow the procedure described below to start Panorama Maker 5.

#### **Windows**

Choose **Start** menu → **All Programs** → **ArcSoft Panorama Maker 5** → **Panorama Maker 5**.

#### **Mac OS X**

Open **Applications** and double-click the **Panorama Maker 5** icon.

- For more information on using Panorama Maker 5, refer to the on-screen instructions and help information contained in Panorama Maker 5.

### **Image File Names and Folder Names**

See "File and Folder Names" (📖203) for more information.

## Connecting to a Printer

Users of PictBridge-compatible (📖220) printers can connect the camera directly to the printer and print pictures without using a computer. The steps for printing are as follows.

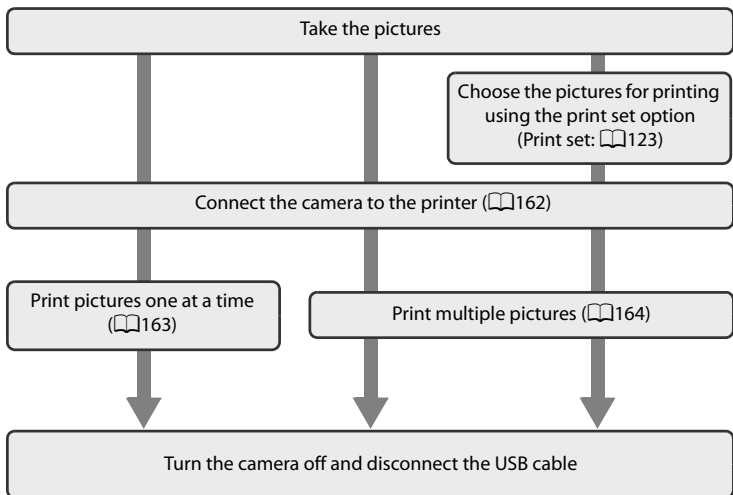

### ✓ Notes on Power Source

- When connecting the camera to a printer, use a fully charged battery to prevent the camera from turning off unexpectedly.
- If the AC Adapter EH-5a and the Power Connector EP-5A (available separately) are used, COOLPIX P7000 can be powered from an electrical outlet. Do not, under any circumstances, use an AC Adapter other than the EH-5a or a Power Connector other than the EP-5A.

### 📷 Printing Pictures

In addition to printing pictures transferred to a computer and printing pictures with a direct camera-to-printer connection, the following options are also available for printing pictures recorded on the memory card:

- Insert a memory card into a DPOF-compatible printer's card slot.
- Take a memory card to a digital photo lab.

For printing using these methods, specify the pictures and the number of prints each using the **Print set** (📖123) option in the playback menu.

## Connecting the Camera and Printer

- 1 Turn off the camera.

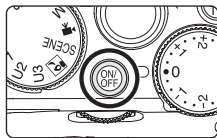

- 2 Turn on the printer.

- Check the printer settings.

- 3 Connect the camera to the printer using the supplied USB cable.

- Be sure that the connector is oriented correctly. When disconnecting the cable, do not pull the connector at an angle.

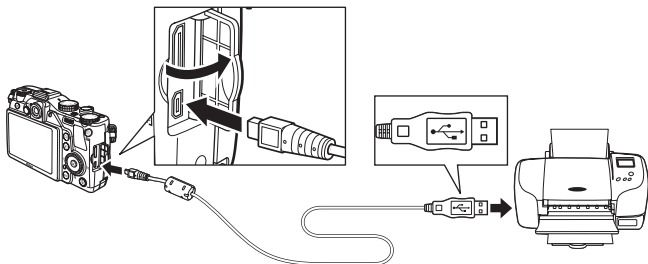

- 4 Turn on the camera.

- When connected correctly, the **PictBridge** startup screen (①) is displayed in the camera monitor. Then the **Print selection** screen (②) is displayed.

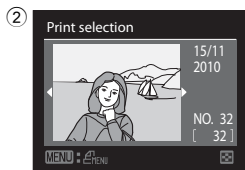
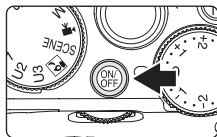

### More Information

See "Printing Images of Size 1:1" (□72) for more information.



## Printing Pictures One at a Time

After connecting the camera to the printer correctly (162), print pictures by following the procedure below.

**1** Use the rotary multi selector to choose the picture to be printed and press the **OK** button.

- Pictures can also be chosen by rotating the command dial.
- Rotate the zoom control to **W** (16) to display 12 thumbnails, or to **T** (17) to switch back to full-frame playback.

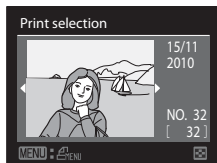

**2** Choose **Copies** and press the **OK** button.

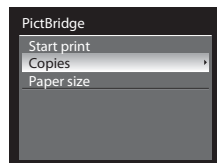

**3** Choose the number of copies (up to nine) and press the **OK** button.



**4** Choose **Paper size** and press the **OK** button.

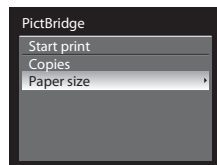

**5** Choose the desired paper size and press the **OK** button.

- To specify the paper size using the printer settings, choose **Default** in the paper size menu.

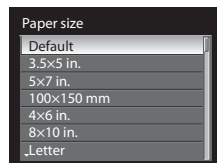

## 6 Choose **Start print** and press the **OK** button.

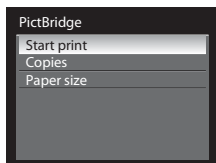

## 7 Printing starts.

- The monitor display returns to that shown in step 1 when printing is complete.
- To cancel before all copies have been printed, press the **OK** button.

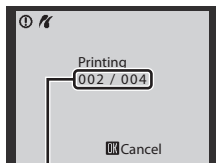

Current print/total number of prints

## Printing Multiple Pictures

After connecting the camera to the printer correctly (162), print pictures by following the procedure below.

### 1 When the **Print selection** screen is displayed, press the **MENU** button.

- The **Print menu** is displayed.

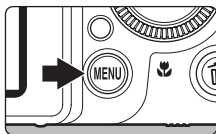

### 2 Use the rotary multi selector to choose **Paper size** and press the **OK** button.

- To exit the print menu, press the **MENU** button.

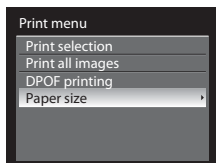

### 3 Choose the desired paper size and press the **OK** button.

- To specify the paper size using the printer settings, choose **Default** in the paper size menu.

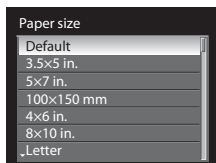

#### 4 Choose **Print selection**, **Print all images** or **DPOF printing** and press the **OK** button.

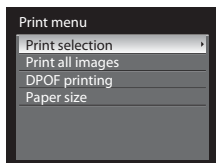

##### Print selection

Choose the pictures (up to a maximum of 99) and number of copies (up to nine per picture).

- Press the rotary multi selector ◀ or ▶ to choose the pictures, and press ▲ or ▼ to set the number of copies for each.
- Pictures can also be chosen by rotating the command dial.
- Pictures selected for printing can be recognized by the check mark icon and the numeral indicating the number of copies to be printed. A check mark is not displayed with pictures for which no copies have been specified and these pictures are not printed.
- Rotate the zoom control to **T** (Q) to switch to full-frame playback, or **W** (R) to switch to 12 thumbnails display.
- Press the **OK** button when setting is complete.
- When the menu shown on the right is displayed, choose **Start print** and press the **OK** button to start printing.
- Choose **Cancel** and press the **OK** button to return to the print menu.

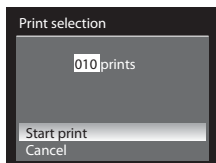

##### Print all images

All pictures stored on the internal memory or memory card are printed one at a time.

- When the menu shown on the right is displayed, choose **Start print** and press the **OK** button to start printing.
- Choose **Cancel** and press the **OK** button to return to the print menu.

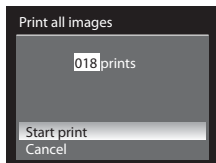

## DPOF printing

Pictures for which a print order was created in **Print set** option (📖123) can be printed.

- When the menu shown on the right is displayed, choose **Start print** and press the **OK** button to start printing.
- Choose **Cancel** and press the **OK** button to return to the print menu.
- To view the current print order, choose **View images** and press the **OK** button. To print pictures, press the **OK** button again.

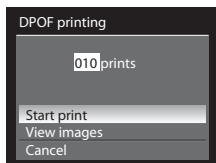

## 5 Printing starts.

- The monitor display returns to that shown in step 2 when printing is complete.
- To cancel before all copies have been printed, press the **OK** button.

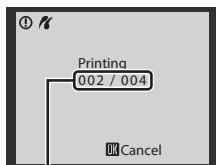

Current print/total number of prints

## Paper Size

The camera supports the following paper sizes: **Default** (the default paper size for the current printer), **3.5×5 in.**, **5×7 in.**, **100×150 mm**, **4×6 in.**, **8×10 in.**, **Letter**, **A3**, and **A4**. Only sizes supported by the current printer are displayed.

## Setup Menu

The setup menu contains the following options.

<b>Welcome screen</b>	169
Choose whether or not to display the welcome screen on the monitor when the camera is turned on.	
<b>Date</b>	170
Set camera clock and choose home and destination time zones.	
<b>Monitor settings</b>	173
Set the picture display after shooting, the screen brightness, and the display options when the monitor is turned on.	
<b>Date imprint</b>	174
Imprint date and time of recording on pictures.	
<b>Vibration reduction</b>	175
Set the vibration reduction for taking still pictures and movies.	
<b>Motion detection</b>	176
Enable motion detection to reduce the effects of camera shake and subject movement when shooting still pictures.	
<b>AF assist</b>	177
Enable or disable AF-assist illumination.	
<b>Red-eye reduction</b>	177
Choose the red-eye reduction method when the flash mode is auto with red-eye reduction.	
<b>Digital zoom</b>	178
Enable or disable the digital zoom.	
<b>Zoom speed</b>	179
Set the zoom operation speed.	
<b>Sound settings</b>	179
Adjust sound settings.	
<b>Record orientation</b>	180
Set whether or not to record the orientation data with the picture when shooting.	
<b>Auto off</b>	181
Set the time before the camera enters standby mode to save power.	
<b>Format memory/Format card</b>	182
Format the internal memory or memory card.	
<b>Language</b>	183
Choose the language used by the camera monitor display.	
<b>TV settings</b>	183
Adjust the settings for connecting to a TV.	
<b>Built-in ND filter</b>	184
Set whether or not to use the camera's built-in ND filter to reduce the light when the shooting mode is <b>P</b> , <b>S</b> , <b>A</b> , <b>M</b> , <b>U1</b> , <b>U2</b> <b>U3</b> or  (low noise night).	

## Setup Menu

### AE/AF lock button

185

Choose the function to be performed when the AE-L/AF-L button is pressed.

### Fn button

186

Choose the function to be performed when the shutter-release button is pressed while pressing the **Fn** button.

### Av/Tv button

187

Choose the function to be performed when the Av/Tv button is pressed.

### Customize My Menu

187

Register frequently used menu items in My Menu.

### Reset file numbering

188

Reset the file numbering.

### Blink warning

189

Choose whether or not to detect blinking eyes when shooting pictures using face priority.

### Reset all

191

Restore camera settings to default values.

### Firmware version

194

Display the camera firmware version.

## Displaying the Setup Menu

Choose the **Y** (Setup) tab in the menu screen.

- 1 Press the **MENU** button to display the menu screen.

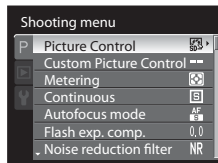
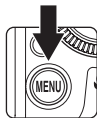

- 2 Press **◀** on the rotary multi selector.

- The tabs can now be selected.
- See "Rotary Multi Selector" (112).

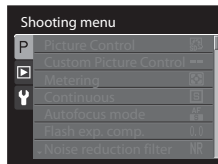

**3** Press ▲ or ▼ to select the **Y** tab.

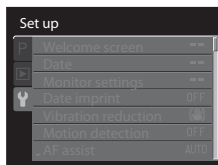

**4** Press ► or the **OK** button.

- The setup menu items can now be selected.
- Use the rotary multi selector to select items and set functions on menus (12).
- To exit the setup menu, press the **MENU** button or press ◀ and switch to another tab.

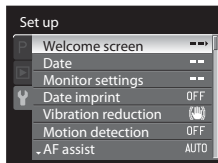

## Welcome Screen

Press the **MENU** button → **Y** (Setup menu) (168) → Welcome screen

Choose whether or not to display the welcome screen on the monitor when the camera is turned on.

### None (default setting)

Displays the shooting or playback screen without displaying the welcome screen.

### COOLPIX

Displays the welcome screen before displaying the shooting or playback screen.

### Select an image

Select a picture that you have shot to display as the welcome screen. Display the picture selection screen, choose a picture (128), and press the **OK** button to register it.

- Because the selected picture is stored in the camera, the picture appears in the welcome screen even if the original picture is deleted.
- NRW (RAW) images cannot be selected.
- Pictures shot with **Image size** (70) of **3648×2432**, **3584×2016** and **2736×2736** cannot be selected.
- Pictures reduced to 160×120 or smaller using Small picture editing (137) or cropping (145) cannot be selected.

## Date

Press the **MENU** button → **Y** (Setup menu) (📖168) → Date

Set the camera's internal clock.

### Date

Set the camera clock to the current date and time. Use the rotary multi selector to set the date and time.

- Choose an item: Press **▶** or **◀** (selected in the following order: **D** (day) → **M** (month) → **Y** (year) → **hour** → **minute** → **DMY** (date display order)).
- Set the contents: Rotate the rotary multi selector, or press **▲** or **▼**.
- Finish setting: Finally, choose **DMY**, and apply the selection by pressing the **OK** button or **▶** (📖21).

**DMY** (date display order)

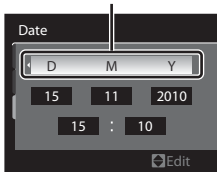

### Time zone

**🏠** (home time zone) can be specified and daylight saving can be enabled or disabled.

When **➔** (travel destination) is registered, the time difference (📖172) from the **🏠** (home time zone) is automatically calculated and the local date and time are recorded. Useful when traveling.

## Setting the Travel Destination Time Zone

**1** Use the rotary multi selector to choose **Time zone** and press the **OK** button.

- The **Time zone** screen is displayed.

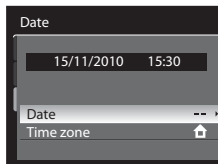

**2** Choose **➔ Travel destination** and press the **OK** button.

- The date and time displayed on the monitor change according to the region currently selected.

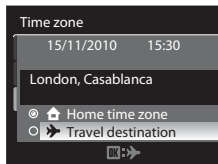



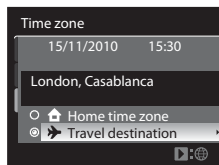

### 3 Press **▶**.

- The time zone selection screen is displayed.



### 4 Press **◀** or **▶** to choose the travel destination (Time zone).

- The time difference between home and the travel destination is displayed.
- When using the camera in an area where daylight saving time is in effect, turn on the daylight saving setting with **▲**. When set to on, the  icon is displayed and the clock advances by one hour. To turn off, press **▼**.
- Press the **OK** button to register the travel destination time zone.
- While the travel destination time zone is selected, the  icon is displayed on the monitor when the camera is in shooting mode.

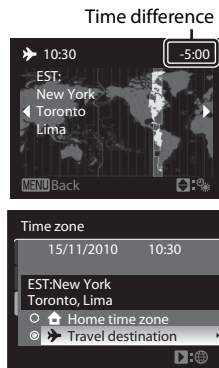

## The Clock Battery

The camera's internal clock uses a different battery from the camera's battery. The clock battery charges when the main battery is installed or the AC adapter is connected, and provides several days of clock battery power after about ten hours of charging.

### **🏠 (Home time zone)**

- To switch to the home time zone, choose **🏠 Home time zone** in step 2 and press the **OK** button.
- To change the home time zone, choose **🏠 Home time zone** in step 2 and perform the same procedure as for **▶ Travel destination** to set the home time zone.

### **Daylight Saving Time**

When daylight saving time starts or ends, turn on or off the daylight saving time option from the time zone selection screen displayed in step 4.

### **Imprinting the Date on Pictures while Shooting**

After setting the date and time, set the **Date imprint** setting in the setup menu ( 174). Once **Date imprint** is set, the shooting date and time can be imprinted on the pictures.

 **Time Zones**

The camera supports the time zones listed below.

For time differences not listed below, set the camera clock using **Date**.

UTC +/-	Location	UTC +/-	Location
-11	Midway, Samoa	+1	Madrid, Paris, Berlin
-10	Hawaii, Tahiti	+2	Athens, Helsinki, Ankara
-9	Alaska, Anchorage	+3	Moscow, Nairobi, Riyadh, Kuwait, Manama
-8	PST (PDT): Los Angeles, Seattle, Vancouver	+4	Abu Dhabi, Dubai
-7	MST (MDT): Denver, Phoenix	+5	Islamabad, Karachi
-6	CST (CDT): Chicago, Houston, Mexico City	+5.5	New Delhi
-5	EST (EDT): New York, Toronto, Lima	+6	Colombo, Dhaka
-4.5	Caracas	+7	Bangkok, Jakarta
-4	Manaus	+8	Beijing, Hong Kong, Singapore
-3	Buenos Aires, Sao Paulo	+9	Tokyo, Seoul
-2	Fernando de Noronha	+10	Sydney, Guam
-1	Azores	+11	New Caledonia
±0	London, Casablanca	+12	Auckland, Fiji

## Monitor Settings

Press the **MENU** button → **Y** (Setup menu) (📖168) → **Monitor settings**

Change the settings for the options below.

### Image review

**On** (default setting): Picture is displayed on the monitor immediately after it is taken and the monitor display returns to shooting mode.

**Off**: Picture is not displayed after it is taken.

**Zoom in on active focus point**: Picture is displayed on the monitor immediately after it is taken and the monitor display returns to the shooting mode. An enlarged image of the focused section is displayed in the area where focusing is performed.

### Brightness

Choose from five settings to select the monitor brightness. The default setting is **3**.

### Photo info

Choose the display options that are displayed on the monitor during shooting. Separate display options can be selected for when the monitor display (📖14) is set to **Show info** and when it is set to **Hide info**. In the default setting, all options are hidden.

- To select show or hide, choose an option with the rotary multi selector, and then press the **OK** button to turn the check box on  or off.
- After finishing the setting, choose **Confirm** and press the **OK** button.

#### Virtual horizon

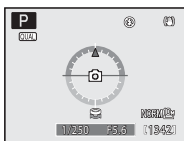

Display the virtual horizon for checking whether the camera is horizontal. When the camera is horizontal or vertical, the horizontal line on the virtual horizon display turns green.

#### View/hide histograms

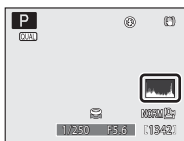

Display a graph that shows the brightness distribution in the picture. The horizontal axis corresponds to pixel brightness, with dark tones to the left and bright tones to the right. The vertical axis shows the number of pixels.

#### View/hide framing grid

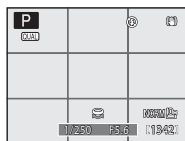

Display a boxed guide for framing.

### Notes on Monitor Display Settings

- The display options are not displayed in auto mode, scene mode or low noise night mode. Only the grid is displayed in movie mode.
- In shooting modes **U1**, **U2** and **U3**, **Photo info** in the setup menu settings cannot be set. Select the **U1**, **U2** or **U3** tab and set **Photo info** in the specialized menus for **U1**, **U2** and **U3** (📖13, 112).

## Date Imprint

Press the **MENU** button →  (Setup menu) (📖168) → Date imprint

The shooting date and time can be imprinted on pictures at the time of shooting. This information can be printed even from printers that do not support printing of the date and time (📖125).



### Date

The date is imprinted on pictures.

### Date and time

The date and time are imprinted on pictures.

### Off (default setting)

The date and time are not imprinted on pictures.

At settings other than **Off**, the icon for the current setting is displayed on the monitor (📖6).

## ✓ Notes on Date Imprint

- Imprinted dates cannot be deleted from the image, nor can dates be imprinted after the picture has been taken.
- Dates cannot be imprinted in the following situations.
  - When **Sports**, **Museum** or **Panorama assist** is selected for scene mode
  - When **Continuous**, **BSS** or **Continuous flash** is selected for the **Continuous** setting (📖99)
  - When **Auto bracketing** (📖80) is used
  - During movie recording
  - When **NRW (RAW)**, **NRW (RAW) + Fine**, **NRW (RAW) + Normal** or **NRW (RAW) + Basic** is selected for **Image quality** (📖68)
- Dates imprinted with an **Image size** (📖70) setting of **VGA 640×480** may be difficult to read. Set the Image size to **PC 1024×768** or larger.
- The date is recorded using the format selected in the setup menu's **Date** option (📖20, 170).

## 📝 Date imprint and Print set

When printing from DPOF-compatible printers which support printing of shooting date and photo information, the date and information can be printed on pictures without the date and time being imprinted on them with **Date imprint**, using options in the **Print set** menu (📖123).

## Vibration Reduction

Press the **MENU** button → **Y** (Setup menu) (📖168) → **Vibration reduction**

Set the vibration reduction for taking still pictures and movies. Use to correct blur, which is caused by the slight hand movements known as camera shake that commonly occur when shooting at the telephoto zoom position or at slow shutter speeds.

When the camera is stabilized for still picture shooting with a tripod, set vibration reduction to **Off**.

### On (default setting)

Compensates for camera shake. The camera automatically detects the panning direction and only corrects for vibration caused by camera shake.

When the camera is panned horizontally, for example, vibration reduction only reduces vertical shake. If the camera is panned vertically, vibration reduction only compensates for horizontal shake.

### Off



Vibration reduction is disabled.

When vibration reduction is enabled, the current setting is displayed during shooting (📖6, 25). Nothing is displayed when the setting is **Off**.

### ✔ Notes on Vibration Reduction

- After the power is turned on or the camera enters shooting mode from playback mode, wait until the display stabilizes before shooting.
- Due to the characteristics of the vibration reduction function, images displayed on the monitor immediately after shooting may appear blurry.
- Vibration reduction may be unable to completely eliminate the effects of camera shake in some situations.

## Motion Detection

Press the **MENU** button →  (Setup menu) (168) → Motion detection

Enable motion detection to reduce the effects of camera shake and subject movement when shooting still pictures.

### Auto

When the camera detects the movement of the subject or camera shake, the ISO sensitivity is raised and the shutter speed is increased to reduce their effects. However, motion detection does not function in the following situations.

- When the fill flash fires
- In the following scene modes: **Sports, Night portrait, Dusk/dawn, Night landscape, Museum, Fireworks show** and **Backlighting**
- When shooting mode is **P, S, A, M, U1, U2, U3** or  (low noise night)
- When the smile timer is set
- When **Subject tracking** is selected for AF area mode

### Off (default setting)

Motion detection is not applied.

When motion detection is enabled, the current setting is displayed during shooting (6).

The motion detection icon lights in green when the camera detects any vibration and increases the shutter speed. Nothing is displayed when the setting is **Off**.

### Notes on Motion Detection

- Motion detection may be unable to completely reduce effects of camera shake and subject movement in some situations.
- Motion detection may not function if the subject exhibits significant movement or is too dark.
- The pictures taken may become grainy.

## AF Assist

Press the **MENU** button →  (Setup menu) (📖168) → AF assist

Enable or disable the AF-assist illumination that assists the autofocus when the lighting is poor.

### Auto (default setting)

AF-assist illumination turns on automatically when the subject is poorly lit. The illuminator has a range of about 6.5 m (21 ft.) at the maximum wide-angle position and about 5.5 m (18 ft.) at the maximum telephoto position. However, for some focus areas and scene modes, AF-assist illumination does not turn on even if **Auto** is set.

### Off

Disable the function. The camera may be difficult to focus if lighting is poor.

### Note on the AF assist Illuminator

In shooting modes **U1**, **U2** and **U3**, **AF assist** in the setup menu settings cannot be set. Select the **U1**, **U2** or **U3** tab and set **AF assist** in the specialized menus for **U1**, **U2** and **U3** (📖13, 112).

## Red-eye Reduction

Press the **MENU** button →  (Setup menu) (📖168) → Red-eye reduction

Choose the red-eye reduction method when the flash mode (📖32) is  (Auto with red-eye reduction).

### Pre-flash on (default setting)

The flash repeatedly fires pre-flashes at low intensity before the main flash to reduce the red-eye effect, and it then performs the red-eye reduction process using picture compensation.

Note that there is a slight lag between the shutter-release button being pressed and the picture being shot.

### Pre-flash off

Pre-flashes do not fire. The shutter is released immediately when the shutter-release button is fully pressed, and the red-eye reduction process is performed using picture compensation.

## Digital Zoom

Press the **MENU** button → **Y** (Setup menu) (📖168) → Digital zoom

Enable or disable the digital zoom.

### On (default setting)

When the camera is zoomed in to the maximum optical zoom position, rotating and holding the zoom control at **T** (📖) triggers the digital zoom (📖27).

### Crop

Limit zoom magnification up to the position of **📐** (except when recording a movie). Also limit the digital zoom to the range at which image quality of the shot still picture does not deteriorate.

The digital zoom is not available when Image size is **📐 3648×2736**, **📐 3264×2448**, **📐 3648×2432**, **📐 3584×2016** or **📐 2736×2736**.

### Off

The digital zoom is not activated (except when recording a movie).

## ✔ Notes on Digital Zoom

- When the digital zoom is in effect, AF area mode is set to **Center (spot)** (📖84).
- Digital zoom cannot be used in the following situations.
  - When the focus mode (📖40) is set to **MF** (manual focus)
  - When **Subject tracking** is selected for AF area mode (📖84)
  - When Smile timer is set
  - When **Scene auto selector**, **Portrait** or **Night portrait** is selected in scene mode
  - When **NRW (RAW)**, **NRW (RAW) + Fine**, **NRW (RAW) + Normal** or **NRW (RAW) + Basic** is selected for **Image quality** (📖68)
  - When **Multi-shot 16** is selected for the **Continuous** (📖99) setting
  - When **Wide-angle converter** (📖104) is set to **On**
- At magnifications of 1.2x to 1.8x, **Metering** is set to **Center-weighted**, and at magnifications of 2.0x to 4.0x, it is set to **Spot**.



## Zoom Speed

Press the **MENU** button → **Y** (Setup menu) (📖168) → Zoom speed

Set the zoom operation speed. Slow down the zoom speed to minimize the recording of the zoom operating noise during movie recording.

### Auto (default setting)

During still picture shooting, operate the zoom at the **Normal** speed. During movie recording, operate the zoom at a lower speed than **Normal** to minimize the recording of the zoom operating noise. During still picture shooting, rotating the zoom control all the way in either direction adjusts the zoom quickly, while rotating the control partially adjusts the zoom slowly.

### Normal

During both still picture shooting and movie recording, operate the zoom at the standard speed. During both still picture shooting and movie recording, rotating the zoom control all the way in either direction adjusts the zoom quickly, while rotating the control partially adjusts the zoom slowly.

### Quiet

During both still picture shooting and movie recording, operate the zoom at a lower speed than **Normal**.

The zoom speed setting is shown by an icon displayed on the monitor during shooting (📖6). At settings other than **Auto**, the icon for the current setting is displayed on the monitor.

## Sound Settings

Press the **MENU** button → **Y** (Setup menu) (📖168) → Sound settings

Adjust the following sound settings.

### Button sound

Turn the beep and start-up sounds **On** (default setting) or **Off**. The beep sounds once when the settings are completed successfully, twice when the camera focuses on the subject, and three times when an error is detected.

### Shutter sound

Choose whether to set the shutter sound to **On** (default setting) or **Off**.

- Even when **On** is set, the shutter sound is not made during continuous shooting or movie recording.

## Record Orientation

Press the **MENU** button → **Y** (Setup menu) (📖168) → Record orientation

Set whether or not to record the orientation data with the picture when shooting.

### Auto (default setting)

Record the orientation data with the picture when shooting. When the picture is played back, the recorded orientation data is used to automatically rotate the picture for display.

The following three data orientation types for the camera can be recorded.

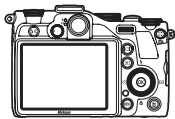

Horizontal position



Vertical position with  
the left side on top



Vertical position with  
the right side on top

### Off

The orientation data is not recorded. Pictures are always displayed in the horizontal position.

The orientation data can be changed after shooting using **Rotate image** in the playback menu (📖130).

### ✓ Notes on Recording the Orientation Data

- In continuous or auto bracketing mode, all pictures are recorded with the same orientation data as the first picture.
- Correct orientation data may not be obtained for pictures recorded with the camera facing up or down.

## Auto Off

Press the **MENU** button →  (Setup menu) (168) → Auto off

If no operations are performed for a certain period while the camera is on, the monitor is turned off to save power and the camera enters standby mode (19). In this menu, set the time before the camera enters standby mode. Choose from **30 s**, **1 min** (default setting), **5 min** and **30 min**.

### When the Monitor Is Turned Off to Save Power



- The power-on lamp blinks in standby mode.
- The camera turns off when the standby mode continues for about three minutes.
- When the power-on lamp blinks, turn on the monitor again with one of the following operations.
  - Press the power switch, shutter-release button or the  button.
  - Rotate the mode dial.

### Auto Off Setting

In the following situations, the time taken for the camera to enter standby mode is fixed.

- When menus are displayed: three minutes
- When tone level information is displayed (shooting mode): three minutes
- During slideshow playback: maximum of 30 minutes
- When the AC adapter EH-5a is connected: 30 minutes

## Format Memory/Format Card

Press the MENU button →  (Setup menu) ( 168) → Format memory/Format card

Format the internal memory or a memory card.

### Formatting Internal Memory

To format the internal memory, remove the memory card from the camera. The **Format memory** option appears in the setup menu.

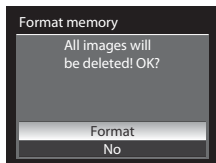

### Formatting Memory Card

When the memory card is inserted in the camera, the **Format card** option appears in the setup menu.

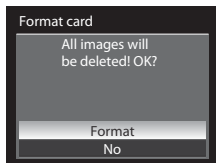

### Formatting Internal Memory and Memory card

- **Formatting the internal memory or memory card permanently deletes all data.** Be sure to transfer important pictures to a computer before formatting.
- Do not turn off the camera or open the battery-chamber/memory card slot cover during formatting.
- The first time you insert a memory card that has been used in another device into this camera, be sure to format it with this camera.

## Language

Press the **MENU** button → **Y** (Setup menu) (📖168) → Language

Choose one of 24 languages for displaying the camera menus and messages.

<b>Čeština</b>	Czech	<b>Italiano</b>	Italian	<b>Svenska</b>	Swedish
<b>Dansk</b>	Danish	<b>Magyar</b>	Hungarian	<b>Türkçe</b>	Turkish
<b>Deutsch</b>	German	<b>Nederlands</b>	Dutch	عربي	Arabic
<b>English</b>	(default setting)	<b>Norsk</b>	Norwegian	简体中文	Simplified Chinese
<b>Español</b>	Spanish	<b>Polski</b>	Polish	繁體中文	Traditional Chinese
<b>Ελληνικά</b>	Greek	<b>Português</b>	Portuguese	日本語	Japanese
<b>Français</b>	French	<b>Русский</b>	Russian	한글	Korean
<b>Indonesia</b>	Indonesian	<b>Suomi</b>	Finnish	ภาษาไทย	Thai

## TV Settings

Press the **MENU** button → **Y** (Setup menu) (📖168) → TV settings

Adjust the settings for connecting to a TV.

### Video mode

Choose from **NTSC** and **PAL**.

### HDMI

Choose a picture resolution for HDMI output from **Auto** (default setting), **480p**, **720p**, or **1080i**. When **Auto** is set, the output resolution that is best suited to the connected high-definition TV is selected automatically from **480p**, **720p** or **1080i**.

### HDMI device control

Choose whether or not to receive signals from a TV when a TV that conforms to the HDMI-CEC standard is connected with an HDMI cable.

When set to **On** (default setting), the television remote control can be used to operate the camera during playback instead of the rotary multi selector or zoom control. Picture selection, movie playback and pause, and switching between full-frame playback and four thumbnails display can be performed.

- See your TV's manual or other related documentation to check whether the TV supports the HDMI-CEC standard.



### HDMI and HDMI-CEC

"HDMI" is an abbreviation of High-Definition Multimedia Interface, which is one type of multimedia interface. "HDMI-CEC" is an abbreviation of HDMI-Consumer Electronics Control, which enables operations to be linked between compatible devices.

## Built-in ND Filter

Press the **MENU** button → **Y** (Setup menu) (📖168) → Built-in ND filter

When the camera's built-in ND filter is used, the amount of light that enters the camera while shooting can be reduced in three steps. Use in situations such as when overexposure results from the subject being too bright. Set whether or not to use the built-in ND filter to reduce the light in the following shooting modes.

-  (low noise night) mode
- **P**, **S**, **A** and **M** modes (including **U1**, **U2** and **U3** modes)

In shooting modes other than the above, the on/off setting of the built-in ND filter is controlled automatically according to the shooting mode and shooting conditions, regardless of **Built-in ND filter** setting.

### On

Use the ND filter to reduce the light.

### Auto

In mode  (low noise night) or **P** (Programmed auto), when the subject is too bright and the exposure range is exceeded, reduce the light automatically with the ND filter.

- In shooting modes **S**, **A** or **M**, the ND filter is disabled.

### Off (default setting)

The ND filter is not used.

The setting for the built-in ND filter is shown by an icon displayed on the monitor during shooting (📖6). Nothing is displayed when the setting is **Off**,  (auto), scene or movie mode.

## Effects of the Built-in ND Filter

Using the filter may enable the shooting of subjects that are too bright without overexposing the image. It can also be used in situations such as when you want to slow down the shutter speed at a low aperture value.

For example, at a shutter speed of 1/2000 second with the correct exposure, if the ND filter is used to reduce the light in three steps, the speed can be changed to 1/250 second without changing the aperture value.

## AE/AF Lock Button

Press the **MENU** button →  (Setup menu) (📖168) → AE/AF lock button

Choose the function to be performed when the AE-L/AF-L button () is pressed during still picture shooting.

### AE/AF lock (default setting)

Lock both the focus and exposure when the AE-L/AF-L button is pressed while shooting.

### AE lock only

Lock only the exposure when the AE-L/AF-L button is pressed while shooting.

### AF lock only

Lock only the focus when the AE-L/AF-L button is pressed while shooting.

The AE-L/AF-L button setting is displayed on the monitor during shooting ()6).

### Notes on AE-L/AF-L Button Setting

- AE-L (exposure locking) cannot be used when the shooting mode is set to **M**.
- AF-L (focus locking) cannot be used when focus mode ()40) is set to **MF** (manual focus).

### More Information

See "Focus Lock" ()29) for more information.

## Fn Button

Press the **MENU** button → **Y** (Setup menu) (📖168) → **Fn** button

Choose the function to be performed when the shutter-release button is pressed while pressing the **Fn** button (📖11).

- This can be used when **P, S, A, M, U1, U2** or **U3** is chosen for shooting mode.

### Off (default setting)

Shoot without changing the setting.

### NRW (RAW)/NORMAL (Image quality) (📖68)

When **Fine, Normal** or **Basic** is set, shoot with the **NRW (RAW)** setting. When **NRW (RAW)** is set, shoot with the **Normal** setting.

- The Image size is 📖 **3648×2736**.
- When **NRW (RAW) + Fine, NRW (RAW) + Normal** or **NRW (RAW) + Basic** is set, shoot without changing the setting.

### ISO sensitivity (📖74)

Shoot with **ISO sensitivity** set to **Auto**.

### White balance (📖76)

Shoot with **White balance** set to **Auto**.

- Cannot be used when **Picture Control** is set to **Monochrome**.

### Picture Control (📖92)

Shoot with **Picture Control** set to **Standard**.

### Active D-Lighting (📖106)

Shoot with **Active D-Lighting** set to **Normal**.

### Metering (📖98)

Shoot with **Metering** set to **Spot**.



## Av/Tv Button

Press the **MENU** button → **Y** (Setup menu) (📖168) → Av/Tv button

Choose the function to be performed when the Av/Tv button (📖9) is pressed.

### Toggle Av/Tv selection (default setting)

Switch the shutter speed or aperture value setting operation. Each time the Av/Tv button is pressed, the operation switches between the command dial and the rotary multi selector (📖63, 64, 65).

- Available only when **P, S, A, M, U1, U2** or **U3** is selected for shooting mode.

### Virtual horizon, View/hide histograms, View/hide framing grid

Select whether to view or hide the virtual horizon, histogram or framing grid displays (📖173) on the monitor during shooting.

### Built-in ND filter

Change the built-in ND filter (📖184) setting.

## Customize My Menu

Press the **MENU** button → **Y** (Setup menu) (📖168) → Customize My Menu

Register frequently used menu items in My Menu (maximum of six). My Menu is displayed when the quick menu dial is set to **My** and the quick menu button is pressed, allowing settings to be quickly checked or changed (when shooting mode is set to **P, S, A, M, U1, U2** or **U3**).

The following items can be registered.

Picture Control (📖92)	Flash control (📖105)	Vibration reduction (📖175)
Custom Picture Control (📖96)	Noise reduction filter (📖103)	Digital zoom (📖178)
Metering (📖98)	Long exposure NR (📖103)	Format memory/Format card (📖182)
Continuous (📖99)	Distortion control (📖104)	Built-in ND filter (📖184)
Autofocus mode (📖102)	Wide-angle converter (📖104)	- (no setting) (delete)*
Flash exp. comp. (📖102)	Active D-Lighting (📖106)	

\* Choose to remove an item from My Menu.

## Registering into My Menu

**1** Use the rotary multi selector to choose the menu item and press the **OK** button.

- The menu item selection screen is displayed.

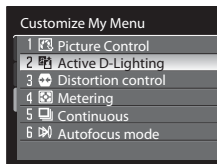

**2** Choose the menu item to be registered and press the **OK** button.

- The chosen menu item is switched.
- To finish the setting, press the rotary multi selector ◀.

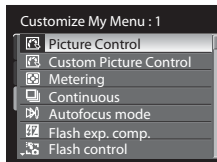

## Reset File Numbering

Press the **MENU** button → **Y** (Setup menu) (📖168) → Reset file numbering

When **Yes** is selected, the sequential numbering of file numbers is reset (📖203).

After resetting, a new folder is created and the file number for the next image taken starts from "0001."

### ✓ Notes on Reset file numbering

- Reset file numbering** cannot be used when scene mode is set to **Panorama assist**, or if **Intvl timer shooting** is chosen for **Continuous** when **P, S, A, M, U1, U2** or **U3** shooting modes are used. For **Panorama assist** or **Intvl timer shooting**, a new folder is created, and file numbers are assigned automatically starting with "0001" (📖203, 204).
- Reset file numbering** cannot be applied when the folder number reaches 999 and there are images in the folder. Insert a new memory card, or format the internal memory/memory card (📖182).

## Blink Warning

Press the **MENU** button → **Y** (Setup menu) (📖168) → **Blink warning**

Choose whether or not blinking eyes are detected when using face priority (📖86) in the following shooting modes.

- **Scene auto selector** (📖46), **Portrait** (📖48) or **Night portrait** (📖49) scene modes
- Shooting modes **P**, **S**, **A**, **M**, **U1**, **U2**, **U3**, and **📷** (low noise night) (when **Face priority** (📖84) is selected for AF area mode)

### On

When the camera detects that a human subject may have closed the eyes immediately after recognizing the face and shooting the subject, the **Did someone blink?** screen appears on the monitor.

The face of the human subject that may have closed his/her eyes is framed by a yellow border. You can check the picture taken and determine if you need to take the picture again.

See "Operating the Did someone blink? Screen" (📖190) for more information.

### Off (default setting)

Blink warning does not take effect.

### ✔ Note on Blink Warning







When a setting other than **Single** is set for **Continuous** (📖99), when **Auto bracketing** (📖80) is set, when the tone level information (📖82) is displayed automatically, or when Smile timer is set (📖36), blink warning does not take effect.

## Operating the Did someone blink? Screen

The following operations can be performed when the **Did someone blink?** screen is displayed.

If no operations are performed for a few seconds, the screen automatically returns to the shooting mode screen.



To	Use	Description
Zoom in to the face for which blinking was detected	<b>T</b> (Q)	Rotate the zoom control to <b>T</b> (Q).
Return to full-frame playback	<b>W</b> (checkered flag)	Rotate the zoom control to <b>W</b> (checkered flag).
Select the face to be displayed		When the camera detects that one or more human subjects have closed their eyes, press ▲, ▼, ◀ or ▶ during playback zoom to display other faces. Can also be changed by rotating the rotary multi selector or the command dial.
		
Delete the picture taken		Press the  button.
Return to shooting mode		Press the  button or the shutter-release button.
		

## Reset All

Press the MENU button → Y (Setup menu) (📖168) → Reset all

When **Reset** is selected, the camera settings are restored to the default values.

## Pop-up Menu

Option	Default value
Flash mode (📖32)	Auto
Self-timer (📖35)/Remote Control (📖38)/Smile timer (📖36)	Off
Focus mode (📖40)	Autofocus
AF area mode (📖84)	Auto

## Shooting in the Scene Mode

Option	Default value
Scene menu (📖45)	Scene auto selector
Hue adjustment in Food mode (📖53)	Center

## Low Noise Night Menu

Option	Default value
Metering (📖59)	Matrix
Continuous (📖59)	Single
Flash exp. comp. (📖59)	0.0

## Movie Menu

Option	Default value
Autofocus mode (📖150)	Single AF
Wind noise reduction (📖150)	Off

**Quick Menu**

Option	Default value
Image quality (📖68)	Normal
Image size (📖70)	📷 3648x2736
Movie options (📖148)	HD 720p (1280x720)
ISO sensitivity (📖74)	Auto
Minimum shutter speed (📖74)	None
White balance (📖76)	Auto
Auto bracketing (📖80)	Off

**Shooting Menu**

Option	Default value
Picture Control (📖92)	Standard
Metering (📖98)	Matrix
Continuous (📖99)	Single
Intvl timer shooting (📖100)	30 s
Autofocus mode (📖102)	Single AF
Flash exp. comp. (📖102)	0.0
Noise reduction filter (📖103)	Normal
Long exposure NR (📖103)	Auto
Distortion control (📖104)	Off
Wide-angle converter (📖104)	None
Flash control (📖105)	Auto
Active D-Lighting (📖106)	Off
Zoom memory (📖107)	All values are chosen.

## Setup Menu

Option	Default value
Welcome screen (📖169)	None
Image review (📖173)	On
Brightness (📖173)	3
Monitor settings (📖173)	Hide all items
Date imprint (📖174)	Off
Vibration reduction (📖175)	On
Motion detection (📖176)	Off
AF assist (📖177)	Auto
Red-eye reduction (📖177)	Pre-flash on
Digital zoom (📖178)	On
Zoom speed (📖179)	Auto
Button sound (📖179)	On
Shutter sound (📖179)	On
Record orientation (📖180)	Auto
Auto off (📖181)	1 min
HDMI (📖183)	Auto
HDMI device control (📖183)	On
Built-in ND filter (📖184)	Off
AE/AF lock button (📖185)	AE/AF lock
Fn button (📖186)	Off
Av/Tv button (📖187)	Toggle Av/Tv selection
Customize My Menu (📖187)	1: Picture Control 2: Active D-Lighting 3: Distortion control 4: Metering 5: Continuous 6: Autofocus mode
Blink warning (📖189)	Off

## Others

Option	Default value
Paper size (📖163, 164)	Default
Frame intvl for Slide show (📖126)	3 s

- Choosing **Reset all** also clears the current file number (📖203) in the memory. After resetting, numbering continues from the lowest number available in the internal memory or the memory card. If **Reset all** is performed after all pictures are deleted from the internal memory or memory card (📖127), the file numbers for the next shot pictures start from 0001.
- The following settings remain unaffected even if **Reset all** is performed.  
**Quick menu:** Preset manual data for **White balance** (📖79)  
**Shooting menu:** **Custom Picture Control** registration (📖96)  
**Setup menu:** **Date** (📖170), **Language** (📖183) and **Video mode** (📖183) in **TV settings**
- User settings that were saved for mode dial **U1**, **U2** and **U3** are not reset to the default settings when **Reset all** is performed. To change these settings back to the default settings, use **Reset user settings** (📖114).

## Firmware Version

Press the **MENU** button → **Y** (Setup menu) (📖168) → Firmware version

Displays the current camera firmware version.

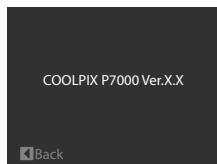



# Caring for the Camera

To ensure continued enjoyment of this Nikon product, observe the following precautions when using or storing the device.

### **Keep dry**

The device will be damaged if immersed in water or subjected to high humidity.

### **Do not drop**

The product may malfunction if subjected to strong shock or vibration.

### **Handle the lens and all moving parts with care**

Do not apply force to the lens, lens cover, monitor, memory card slot or battery chamber. These parts are easily damaged. Applying force to the lens cover could result in camera malfunction or damage to the lens. Should the monitor break, care should be taken to avoid injury caused by broken glass and to prevent the liquid crystal from the display touching the skin or entering the eyes or mouth.

### **Do not point the lens at strong light sources for extended periods**

Avoid pointing the lens at the sun or other strong light sources for extended periods when using or storing the camera. Intense light may cause deterioration of the CCD image sensor, producing a white blur effect in photographs.

### **Keep away from strong magnetic fields**

Do not use or store this device in the vicinity of equipment that generates strong electromagnetic radiation or magnetic fields. Strong static charges or the magnetic fields produced by equipment such as radio transmitters could interfere with the monitor, damage data stored on the memory card, or affect the product's internal circuitry.

### **Avoid sudden changes in temperature**

Sudden changes in temperature, such as when entering or leaving a heated building on a cold day, can cause condensation to form inside the device. To prevent condensation, place the device in a carrying case or a plastic bag before exposing it to sudden changes in temperature.

### **Turn the product off before removing or disconnecting the power source**

Do not remove the battery while the product is on, or while images are being recorded or deleted. Forcibly cutting power in these circumstances could result in loss of data or in damage to product memory or internal circuitry.

### **The Battery**

- Check the battery level when taking the camera out, and charge the battery if necessary. Do not continue charging once the battery is fully charged, as this will result in reduced battery performance. If possible, carry a fully-charged spare battery when taking pictures on important occasions.
- Do not use the battery at ambient temperatures below 0 °C (32 °F) or above 40 °C (104 °F). Failure to observe this precaution could damage the battery or impair its performance.
- Charge the battery in an indoor environment that is between 5 and 35 °C (41 to 95 °F).
- When the battery temperature is between 0 and 10 °C (32 to 50 °F) or 45 to 60 °C (113 to 140 °F), the chargeable capacity may decrease. The battery will not charge if its temperature is below 0 °C (32 °F) or above 60 °C (140 °F).
- If an exhausted battery is used at a low temperature, the camera may not turn on. Be sure that the battery is fully charged and spare batteries are prepared before heading outside to take pictures in cold weather. Keep spare batteries in a warm place and exchange as necessary. Once warmed, a cold battery that could not be used temporarily due to lowered performance may recover some of its charge.
- Should the battery terminals become dirty, the camera may not turn on due to poor contact. Wipe the terminals off with a clean, dry cloth before use.
- Recharge it at least once every six months and run it flat before returning it to storage. Attach the included terminal cover to the battery and store it in a cool location with an ambient temperature of 15 to 25 °C (59 to 77 °F). Do not store the battery in hot or extremely cold locations.
- While the battery is in storage, charge it at least once every six months and then use the camera to run it flat again before storing it in a cool location.
- Always remove the battery from the camera or battery charger when it is not being used. Left installed, minute amounts of current flow even when unused, and the battery may become excessively drained and no longer function.
- A marked drop in the time a fully-charged battery retains its charge, when used at room temperature, indicates that the battery needs to be replaced. Purchase a new battery.
- Replace the battery when it no longer holds a charge. Used batteries are a valuable resource. Please recycle used batteries in accordance with local regulations.

## Cleaning

<b>Lens/ viewfinder</b>	Avoid touching glass parts with your fingers. Remove dust or lint with a blower (typically a small device with a rubber bulb attached to one end that is pumped to produce a stream of air out the other end). To remove fingerprints or other stains that cannot be removed with a blower, wipe the lens with a soft cloth, using a spiral motion that starts at the center of the lens and working toward the edges. If this fails, clean the lens using a cloth lightly dampened with commercial lens cleaner.
<b>Monitor</b>	Remove dust or lint with a blower. To remove fingerprints and other stains, clean the monitor with a soft, dry cloth, being careful not to apply pressure.
<b>Body</b>	Use a blower to remove dust, dirt or sand, then wipe gently with a soft, dry cloth. After using the camera at the beach or seaside, wipe off any sand or salt with a dry cloth lightly dampened with fresh water, then dry thoroughly. Note that foreign matter inside the camera could cause damage not covered by the warranty.

Do not use alcohol, thinner, or other volatile chemicals.

## Storage

Turn the camera off when not in use. Check that the power-on lamp is off before putting the camera away. Remove the battery if the camera will not be used for an extended period. Do not store the camera with naphtha or camphor moth balls, or in any of the following locations:

- Next to equipment that produces strong electromagnetic fields, such as televisions or radios
- Exposed to temperatures below -10 °C (14 °F) or above 50 °C (122 °F)
- Poorly ventilated or subject to humidities of over 60 %

To prevent mold or mildew, take the camera out of storage at least once a month. Turn the camera on and release the shutter a few times before putting the camera away again.



### Notes on the Monitor

- The monitor may contain a few pixels that are always lit or that do not light. This is a characteristic common to all TFT LCD displays, and does not indicate a malfunction. Images recorded using the product will not be affected.
- Images on the monitor may be difficult to see under bright lighting.
- The monitor is lit by an LED backlight. Should the monitor begin to dim or flicker, contact your Nikon-authorized service representative.
- White or colored streaks of light may be visible on the monitor with framing of bright subjects. This phenomenon, known as “smear,” occurs when extremely bright light strikes the image sensor. This is due to characteristics of the image sensor and does not indicate a malfunction. Smear may also cause partial discoloration in monitor display with shooting. Smear does not affect recorded images except when shooting with **Continuous** set to **Multi-shot 16** and when recording movies. When shooting in these modes, avoiding bright objects such as the sun, reflections of the sun, and electric lights is recommended.

## Optional Accessories

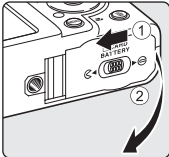
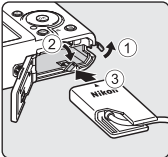
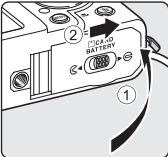
Rechargeable battery	Rechargeable Li-ion Battery EN-EL14
Battery charger	Battery Charger MH-24*
AC adapter/Power connector	<p>AC Adapter EH-5a (connect as shown) and Power Connector EP-5A (connect as shown)</p> <p>When the Power Connector is inserted into the camera and the AC Adapter is connected, the camera can be powered from an electrical outlet.</p> <p>The AC Adapter and the Power Connector are available separately.</p> <p><b>1</b> </p> <p><b>2</b> </p> <p><b>3</b> </p> <p>Before closing the battery-chamber/memory card slot cover, fully insert the cord of the power connector into the slot in the battery chamber. If part of the cord runs out of the groove, the cover or cord may be damaged when the cover is closed.</p> <p>Insert the DC plug of the AC Adapter EH-5a into the DC plug connector of the Power Connector EP-5A.</p>
USB cable	USB Cable UC-E6
Audio/Video cable	Audio Video Cable EG-CP16
Converter lens	Wide-angle Converter WC-E75A (0.75x) (requires Adapter Ring UR-E22)
Lens adapter ring	Adapter Ring UR-E22
Speedlights (external flash unit)	Speedlight SB-400, SB-600, SB-900 Wireless Speedlight Commander SU-800

### Remote control

#### Remote Control ML-L3

How to replace the battery (3 V CR2025 lithium battery) in the remote control.

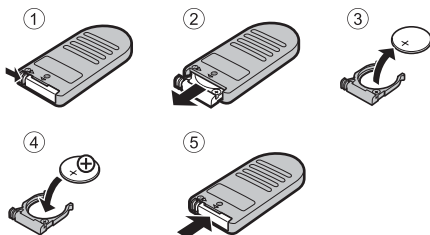

- When changing the remote control battery, be sure that the battery's positive (+) and negative (-) terminals are oriented correctly.
- Be sure to read and follow the warnings for the battery on page iii and the section, "The Battery" (196).

\* When using in other countries, use a commercially available plug adapter as necessary. For more information about plug adapters, consult your travel agency. See our websites or product catalogs for up-to-date information on accessories for the COOLPIX P7000.

**✔ Converter and Adapter Ring**

- Be sure to set **Wide-angle converter** (📖104) to **On**.
- Do not attach lens hoods or filters to the converter lens or adapter ring, as they may cause shading around the edges of pictures.



**✔ External Flash**

The accessory shoe for the COOLPIX P7000 is compatible with Nikon Speedlights SB-400, SB-600 and SB-900, and the Wireless Speedlight Commander SU-800. Attempting to attach other external flashes may damage the camera and the external flash.

**✔ Use Only Nikon Flash Accessories**

Use only Nikon Speedlights. Negative voltages or voltages over 250 V applied to the accessory shoe could not only prevent normal operation, but damage the sync circuitry of the camera or flash.

## Using Speedlights (External Flash Unit)

The camera is equipped with an accessory shoe, allowing Speedlights SB-400, SB-600 or SB-900 (available separately) to be mounted on the camera. Use Speedlights for indirect lighting or when additional lighting is required. The built-in flash is changed to  (Off) automatically when using Speedlights. While  is displayed on the monitor, the Speedlight flash mode is also displayed on the monitor, and it can be set with the same procedure as the built-in flash ( 32).

- Remove the accessory shoe cover before attaching a Speedlight unit as shown on the right.
- When the built-in flash is raised, gently push to lower the flash until it clicks shut.
- Refer to the Speedlight manual for more information on how to attach Speedlight and details on how to use it.
- Replace the accessory shoe cover when the Speedlight is not in use.

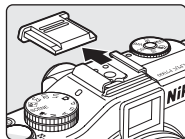

### Speedlights SB-400, SB-600 and SB-900

- Before using Speedlights SB-600 or SB-900, set the Speedlight flash control mode to TTL. This enables the i-TTL flash control to use monitor pre-flashes to adjust flash output automatically in response to lighting conditions. Refer to the Speedlight manual for more information on i-TTL flash control.
- Wireless multiple flash shooting can be performed by setting the SB-900 or Wireless Speedlight Commander SU-800 to “commander,” and setting the SB-600 and SB-900 to “remote flash.” However, the flash is not usable even if the monitor pre-flashes are fired when the SB-900 is set to “commander.”

The Wireless multiple flash group setting is only applicable to group A. Change the setting for both the commander and the remote flash to group A. Refer to the Speedlight manual for more information.

- When wireless multiple flash shooting, if ISO sensitivity is set to **Auto, High ISO sensitivity auto, ISO 100-200** or **ISO 100-400**, it is fixed to ISO 100.
- The camera does not support Flash Color Information Communication, Auto FP High-Speed Sync, FV lock, or AF-assist for multi-area AF when using Speedlights SB-600 or SB-900.
- Power zoom function can be used with Speedlights SB-600 or SB-900, setting zoom head position automatically depending upon focal length.
- When using Speedlights SB-600 or SB-900, the edges of pictures shot at ranges under 2 m (6 ft. 7 in.) on the zoom wide-angle side may appear dark. In such cases, use the wide panel.
- When set to STBY (standby), the Speedlight turns on and off at the same time as the camera. Confirm on the Speedlight that the Ready-light is on.



## File and Folder Names

Pictures, movies and voice memos are assigned file names as follows.

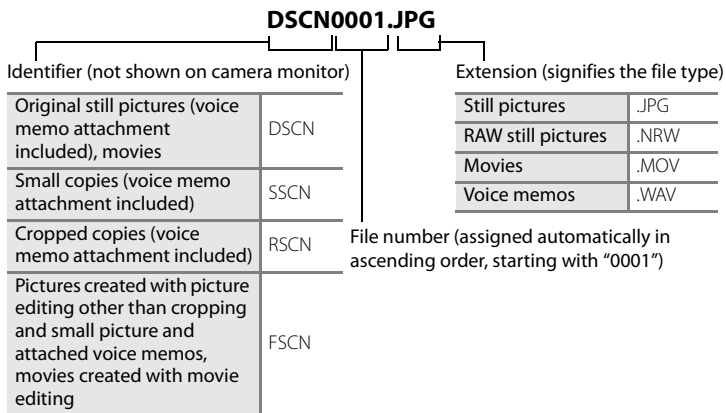











- A folder for storing files is automatically created using the following naming convention: "Folder number + NIKON" (e.g., "100NIKON"). If there are 200 files in a folder, a new folder is created. (For example, the folder name following "100NIKON" becomes "101NIKON.") A new folder is also created when the file numbers in a folder reach 9999 or **Reset file numbering** (📖188) is performed. The next file number is set automatically to "0001." If a folder contains no files, a new folder is not created even if **Reset file numbering** is performed.
- When images are shot with an **Image quality** (📖68) setting of **NRW (RAW) + Fine, NRW (RAW) + Normal** or **NRW (RAW) + Basic**, the NRW (RAW) and JPEG images that are recorded at the same time are assigned the same file name. The NRW (RAW) and JPEG images that are recorded at the same time are saved in the same folder. If there are 199 files in a folder, a new folder is created and the images are saved in the new folder.
- Voice memo file names have the same identifier and file number as the picture to which the voice memo is attached.

## File and Folder Names









- In Panorama assist (📖55), a folder is created for each shooting session using the following naming convention: "Folder number + P\_XXX" (e.g., "101P\_001"). Pictures are saved in sequence in file numbers starting from 0001.
- Each time a picture is taken in Interval timer shooting (📖99), a folder named with the convention: 'Folder number + INTVL' (e.g., 101INTVL) is created. Pictures are saved in sequence in file numbers starting from 0001.
- When image files or voice files are copied to or from the internal memory or memory card (📖131), the file naming conventions are as follows:
  - Files copied using **Selected images** are copied to the current folder (or to the folder used for subsequent pictures), where they are assigned file numbers in ascending order following the largest file number in memory.
  - Files copied using **All images**, along with their folder, are copied together. Folder numbers are assigned in ascending order, following the largest folder number on the destination medium.  
File names are not changed.
- When the current folder is numbered 999, if there are 200 files in the folder or if a file is numbered 9999, no further pictures can be shot until the internal memory or memory card is formatted (📖182), or a new memory card is inserted.

## Error Messages

The following table lists the error messages and other warnings displayed on the monitor, as well as the solutions for dealing with them.











Display	Description	Solution	
 (blinks)	Clock not set.	Set clock.	170
	Battery is running low.	Prepare to charge or change battery.	16, 18
 Battery exhausted.	Battery exhausted.	Charge or change battery.	16, 18
 Battery temperature high	Battery temperature is high.	Turn off camera, and allow battery to cool down before resuming use. Five seconds after this message appears, the monitor is turned off, and the power-on lamp, the AF lamp and the flash lamp flicker. After the lamps blink for three minutes, the camera turns off automatically, but you can also press the power switch to turn it off manually.	19
 Please wait for the camera to finish recording.	Camera cannot perform other operations until recording is complete.	Wait until message clears from display automatically when recording is complete.	–
 Memory card is write protected.	Write-protect switch is in “lock” position.	Slide the write-protect switch to “write” position.	23
 This card cannot be used.	Error accessing memory card.	<ul style="list-style-type: none"> <li>• Use an approved card.</li> <li>• Check that connectors are clean.</li> <li>• Confirm that memory card is correctly inserted.</li> </ul>	221
 This card cannot be read.			22
 Card is not formatted. Format card? Yes No	Memory card has not been formatted for use in this camera.	All data stored on the memory card is deleted when formatted. If there is any data on the card that you want to keep, select <b>No</b> , and backup the data to a computer before formatting the memory card. To format the memory card, select <b>Yes</b> and press the  button.	23















## Error Messages

Display	Description	Solution	
 Out of memory.	Memory card is full.	<ul style="list-style-type: none"> <li>Choose lower image quality or smaller image size.</li> <li>Delete pictures and movies.</li> <li>Replace memory card.</li> <li>Remove memory card and use internal memory.</li> </ul>	68, 70 31, 127, 153 22 22
 Image cannot be saved.	Error occurred while recording picture.	Format the internal memory or memory card.	182
	Camera has run out of file numbers.	Replace the memory card, or format the internal memory/memory card.	22, 182
	Picture cannot be used for welcome screen.	<p>The following pictures cannot be used.</p> <ul style="list-style-type: none"> <li>NRW (RAW) images</li> <li>Pictures shot with <b>Image size of  3648x2432,  3584x2016 or  2736x2736</b></li> <li>Pictures created with small picture or crop function that are 160x120 or less</li> </ul>	68 70 137, 145
	There is insufficient space to save a copy.	Delete pictures from destination.	127
 Image cannot be modified.	Cannot edit selected picture.	<ul style="list-style-type: none"> <li>Confirm the conditions that are required for editing.</li> <li>RAW processing cannot be performed for NRW (RAW) pictures that were taken with a camera other than COOLPIX P7000.</li> <li>These options cannot be used with movies.</li> </ul>	133 - -
 Cannot record movie.	Time out error while recording movie.	Choose memory card with faster write speed.	221
 Cannot reset file numbering.	No more folders can be created.	Insert a new memory card, or format the internal memory/memory card.	22, 182, 188

Display	Description	Solution	
<b>i</b> Memory contains no images.	No pictures in the internal memory or memory card.	<ul style="list-style-type: none"> <li>• Pictures stored in the internal memory can only be viewed if no memory card is inserted.</li> <li>• To copy files from internal memory to memory card, press the <b>MENU</b> button to display the copy screen, then copy the files from internal memory to memory card.</li> </ul>	22 131
<b>i</b> File contains no image data.	File not created with COOLPIX P7000.	File cannot be viewed on this camera. View file using the computer or any other devices which was used to create or edit this file.	–
<b>i</b> All images are hidden.	The picture cannot be played back in a slide show.	–	126
	All images in the internal memory/ memory card are hidden.	Disable the <b>Hide image</b> setting to view images.	130
<b>i</b> This image cannot be deleted.	Picture is protected.	Disable protection.	129
<b>i</b> Travel destination is in the current time zone.	Destination in same time zone as home.	–	172
<b>i</b> Mode dial is not in the proper position.	Mode dial is between two modes.	Rotate the mode dial to select the desired mode.	44
<b>i</b> My Menu can not be changed at current settings.	All registered menu items cannot be changed at the current setting.	<ul style="list-style-type: none"> <li>• Check the settings of functions that are not registered in My Menu.</li> <li>• Change the menu item to be registered in My Menu.</li> </ul>	187
			187

## Error Messages

Display	Description	Solution	
 Press the flash pop-up button to raise the flash.	The built-in flash is lowered when the scene mode is <b>Night portrait</b> or <b>Backlighting</b> , or the Continuous mode is <b>Continuous flash</b> .	Press the  (flash pop-up) button to raise the built-in flash.	33, 49, 55, 99
 The flash is lowered.	The built-in flash is not raised during the scene auto selector mode.	Press the  (flash pop-up) button to raise the built-in flash. The camera can still shoot normally with the flash lowered if you do not wish to use it.	33, 46
 Speedlight setting error	Group A has not been selected for group setting when shooting using wireless lighting.	Set the group setting of the master commander and remote flash to Group A.	202
 Lens error	Lens is not operating properly.	Turn camera off and then on again. If error persists, contact retailer or Nikon-authorized service representative.	19
 Communications error	Error occurred during communication with printer.	Turn off camera and reconnect cable.	157, 162
System error 	Error has occurred in camera's internal circuitry.	Turn off camera, remove and reinsert battery, and turn on camera. If the error persists, contact retailer or Nikon-authorized service representative.	19
 Initializing lens. Cannot focus.	The camera cannot focus.	Wait until the camera recovers automatically.	-





Display	Description	Solution	
 Printer error: check printer status.	Printer error	Check printer. After solving the problem, select <b>Resume</b> and press the  button to resume printing.*	-
 Printer error: check paper	Specified paper size is not loaded.	Load the specified paper size, select <b>Resume</b> and press the  button to resume printing.*	-
 Printer error: paper jam	Paper has jammed in the printer.	Remove the jammed paper, select <b>Resume</b> and press the  button to resume printing.*	-
 Printer error: out of paper	No paper is loaded in the printer.	Load the specified paper size, select <b>Resume</b> and press the  button to resume printing.*	-
 Printer error: check ink	Ink error	Check ink, select <b>Resume</b> and press the  button to resume printing.*	-
 Printer error: out of ink	Ink cartridge is empty.	Replace ink cartridge, select <b>Resume</b> and press the  button to resume printing.*	-
 Printer error: file corrupt	An error caused by the image file has occurred.	Select <b>Cancel</b> and press the  button to cancel printing.	-

\* See the documentation provided with your printer for further guidance and information.

# Troubleshooting

If the camera fails to function as expected, check the list of common problems below before consulting your retailer or Nikon-authorized service representative. Refer to the page numbers in the right-most column for more information.

## Display, Settings and Power Supply

Problem	Cause/Solution	
Monitor is blank.	<ul style="list-style-type: none"><li>• Camera is off.</li><li>• Battery is exhausted.</li><li>• Standby mode for saving power: Press the power switch, shutter-release button or the  button, or rotate the mode dial.</li></ul>	19 24 19, 30
	<ul style="list-style-type: none"><li>• Monitor is turned off. Press the  button to turn it on.</li><li>• Camera and computer are connected via USB cable.</li><li>• Camera and TV are connected via A/V cable or HDMI cable.</li><li>• Interval timer shooting in progress.</li></ul>	14 156 154 100
Monitor is hard to read.	<ul style="list-style-type: none"><li>• Ambient lighting too bright: use viewfinder or move to darker location.</li><li>• Adjust monitor brightness.</li><li>• Monitor is dirty. Clean monitor.</li><li>• Use monitor brightness boost.</li></ul>	26 173 195 15
	The viewfinder is hard to read.	Adjust diopter adjustment control.
Camera turns off without warning.	<ul style="list-style-type: none"><li>• Battery is exhausted.</li><li>• Camera has turned off automatically to save power.</li><li>• Inside of the camera has become hot. Leave the camera off until the inside of the camera has cooled.</li><li>• At low temperatures, the camera and the battery may not function normally.</li></ul>	24 19 - 196
	Date and time of recording are not correct.	<ul style="list-style-type: none"><li>• If the date has not been set ("Date not set" indicator blinks during shooting), still pictures have a time stamp of "00/00/0000 00:00"; and movies are dated "01/01/10 00:00." Set the correct date and time using <b>Date</b> in the setup menu.</li><li>• The camera clock is not as accurate as a normal clock, such as watches. Check camera clock regularly against more accurate timepieces and reset as required.</li></ul>
No information displayed in monitor.	Shooting data and photo information may be hidden. Press the  button until shooting data or photo information is displayed.	14
<b>Date imprint</b> not available.	<b>Date</b> has not been set.	20, 170







Problem	Cause/Solution	
Date not appearing on pictures even when <b>Date imprint</b> is enabled.	<ul style="list-style-type: none"> <li>• A shooting mode that does not support date imprint is selected.</li> <li>• Another function that is set now is restricting the date imprinting.</li> <li>• The date cannot be imprinted onto a movie.</li> </ul>	174 174 -
Camera settings reset.	Clock battery is exhausted; all settings were restored to their default values.	171
<b>Reset file numbering</b> cannot be done.	<ul style="list-style-type: none"> <li>• <b>Reset file numbering</b> cannot be applied when the folder number reaches 999 and there are images in the folder. Change the memory card, or format the internal memory/memory card.</li> <li>• <b>Reset file numbering</b> cannot be set when the scene mode is set to <b>Panorama assist</b>, or when the shooting mode is <b>P, S, A, M, U1, U2</b> or <b>U3</b> and <b>Intvl timer shooting</b> is chosen for <b>Continuous</b> in the shooting menu.</li> </ul>	188, 203  55, 99, 188, 203
Monitor is turned off, and the power-on lamp blinks rapidly.	Battery temperature is high. Turn off camera, and allow battery to cool down before resuming use. After the lamp blinks for three minutes, the camera turns off automatically, but you can also press the power switch to turn it off manually.	19
Camera temperature rises.	When functions such as movie recording are used for a long time, or when the camera is used in a location with a high ambient temperature, the camera temperature may rise. This is not a malfunction.	147







### Electronically Controlled Cameras

In extremely rare instances, unusual characters may appear on the monitor and the camera may stop functioning. In most cases, this phenomenon is caused by a strong external static charge. Turn the camera off, remove and replace the battery, then turn the camera on again. Note that disconnecting the power source as described above may result in the loss of any data not recorded on the internal memory or memory card at the time the problem occurred. Data already recorded is not affected. In the event of continued malfunction, contact your retailer or Nikon-authorized service representative.

## Shooting





Problem	Cause/Solution	
Cannot set to shooting mode	Disconnect the audio/video cable, HDMI cable or USB cable.	154, 157, 162
No picture taken when shutter-release button is pressed.	<ul style="list-style-type: none"> <li>When camera is in playback mode, press the  or shutter-release button.</li> <li>When menus are displayed, press the <b>MENU</b> button.</li> <li>Battery is exhausted.</li> <li>When the scene mode is <b>Night portrait</b> or <b>Backlighting</b>, or <b>Continuous</b> in the shooting menu is set to <b>Continuous flash</b>, raise the built-in flash.</li> <li>When flash lamp blinks, flash is charging.</li> </ul>	30 13 24 33, 49, 55, 99 34
Camera cannot focus.	<ul style="list-style-type: none"> <li>The intended subject is one with which autofocus does not perform well.</li> <li>Set <b>AF assist</b> in the setup menu to <b>Auto</b>.</li> <li>Subject not in focus area when shutter-release button pressed halfway.</li> <li>The focus mode is set to <b>MF</b> (manual focus).</li> <li>Turn camera off and then on again.</li> </ul>	29 177 28, 84 40 19
Pictures are blurred.	<ul style="list-style-type: none"> <li>Use flash.</li> <li>Use vibration reduction and motion detection.</li> <li>Use <b>BSS</b> (Best Shot Selector).</li> <li>Use a tripod to stabilize the camera (use with the self-timer for better results).</li> </ul>	32 175, 176 99 35
Streaks of light or partial discoloration are visible on the monitor.	Smear occurs when extremely bright light strikes the image sensor. When shooting with Continuous set to Multi-shot 16 and when recording movies, avoiding bright objects, such as the sun, reflections of the sun, and electric lights is recommended.	198
Bright specks appear in pictures shot using flash.	Flash is reflecting off particles in air. Set the flash to  (Off).	32
Flash does not fire.	<ul style="list-style-type: none"> <li>Flash is set to  (Off).</li> <li>A scene mode that cannot turn on flash is selected.</li> <li>The movie mode is selected.</li> <li>Another function that is set now is restricting the flash.</li> <li>Built-in flash does not fire when a Speedlight (external flash unit) is used.</li> </ul>	32 45 148 108 202

Problem	Cause/Solution	
Zoom does not operate.	<ul style="list-style-type: none"> <li>• <b>On</b> is selected for <b>Wide-angle converter</b> in the shooting menu.</li> </ul>	104
	<ul style="list-style-type: none"> <li>• When the lens ring is removed while the camera is on, the zoom is fixed in a wide-angle end. Turn the camera off, attach the lens ring, and then turn the camera on again.</li> </ul>	104
Digital zoom is not available.	<ul style="list-style-type: none"> <li>• <b>Off</b> is selected for <b>Digital zoom</b> in the setup menu.</li> </ul>	178
	<ul style="list-style-type: none"> <li>• The digital zoom cannot be used in the following situations.</li> </ul>	
	<ul style="list-style-type: none"> <li>- When the focus mode is set to <b>MF</b> (manual focus)</li> </ul>	40
	<ul style="list-style-type: none"> <li>- When <b>Subject tracking</b> is selected for AF area mode</li> </ul>	85
	<ul style="list-style-type: none"> <li>- When <b>Smile timer</b> is set</li> </ul>	36
	<ul style="list-style-type: none"> <li>- When <b>Scene auto selector, Portrait</b> or <b>Night portrait</b> is selected in scene mode</li> </ul>	46, 48, 49
<ul style="list-style-type: none"> <li>- When <b>Image quality</b> in the quick menu is set to <b>NRW (RAW), NRW (RAW) + Fine, NRW (RAW) + Normal</b> or <b>NRW (RAW) + Basic</b></li> </ul>	68	
<ul style="list-style-type: none"> <li>- When <b>On</b> is selected for <b>Wide-angle converter</b> in the shooting menu</li> </ul>	104	
<ul style="list-style-type: none"> <li>- When <b>Multi-shot 16</b> is set for <b>Continuous</b> in the shooting menu</li> </ul>	99	
Image size not available.	Another function that is set now is restricting <b>Image size</b> .	108
No sound when shutter is released.	<ul style="list-style-type: none"> <li>• <b>Off</b> is selected for <b>Shutter sound</b> under <b>Sound settings</b> in the setup menu.</li> </ul>	179
	<ul style="list-style-type: none"> <li>• <b>Continuous, BSS, Continuous flash</b> or <b>Multi-shot 16</b> is selected for <b>Continuous</b> in the shooting menu.</li> </ul>	99
	<ul style="list-style-type: none"> <li>• A mode other than <b>Off</b> is selected for <b>Auto bracketing</b> in the quick menu.</li> </ul>	80
	<ul style="list-style-type: none"> <li>• <b>Sports</b> or <b>Museum</b> is selected in scene mode.</li> </ul>	49, 54
	<ul style="list-style-type: none"> <li>• The movie mode is selected.</li> <li>• Do not block the speaker.</li> </ul>	146 5, 26
AF-assist illuminator does not light.	<b>Off</b> is selected for <b>AF assist</b> in the setup menu. Even when <b>Auto</b> is set, AF-assist illuminator may not light depending on the focus area position or scene mode.	177
Pictures appear smeared.	Lens is dirty. Clean lens.	195
Colors are unnatural.	White balance does not match light source.	76

Problem	Cause/Solution	
Randomly spaced bright pixels ("noise") appear in image.	As the subject is dark, shutter speed is too slow or ISO sensitivity is too high. <ul style="list-style-type: none"> <li>• Use flash.</li> <li>• Specify a lower ISO sensitivity setting.</li> <li>• Apply <b>Long exposure NR</b> in the shooting menu to suit situations.</li> <li>• Use a scene mode which has noise reduction.</li> </ul>	32 74 103 45
Pictures are too dark (underexposed).	<ul style="list-style-type: none"> <li>• Flash is set to  (Off).</li> <li>• Built-in flash window is blocked.</li> <li>• Subject is beyond flash range.</li> <li>• Adjust exposure compensation.</li> <li>• Raise the ISO sensitivity.</li> <li>• Subject is backlit. Raise the built-in flash, and set the scene mode to <b>Backlighting</b> or set the flash mode to  (fill flash).</li> <li>• <b>On</b> is selected for <b>Built-in ND filter</b> in the setup menu.</li> </ul>	32 26 32 43 74 32, 55 184
Pictures are too bright (overexposed).	<ul style="list-style-type: none"> <li>• Adjust exposure compensation.</li> <li>• Use <b>Built-in ND filter</b> setting in the setup menu.</li> </ul>	43 184
Unexpected results occurred when flash is set to auto with red-eye reduction.	When  (Auto with red-eye reduction) or "fill flash with slow sync and red-eye reduction" of the <b>Night portrait</b> scene mode is applied during shooting, In-Camera Red-Eye Fix may, in very rare cases, be applied to areas not affected by red-eye. Set a flash mode other than  (Auto with red-eye reduction), select a scene mode other than <b>Night portrait</b> , and resume shooting.	32, 49
Skin softening results are not as expected.	<ul style="list-style-type: none"> <li>• Skin softening may not produce the desired results depending on shooting conditions.</li> <li>• For pictures with four or more faces, try using <b>Skin softening</b> in the playback menu.</li> </ul>	36 139
Saving images takes time.	It may take more time to save images in the following situations. <ul style="list-style-type: none"> <li>• When the noise reduction function is in operation</li> <li>• When flash is set to  (Auto with red-eye reduction)</li> <li>• When using scene mode <b>Portrait</b> or <b>Night portrait</b> while shooting</li> <li>• When using Smile timer while shooting</li> <li>• When using Active D-Lighting while shooting</li> <li>• When <b>Image quality</b> is set to <b>NRW (RAW)</b>, <b>NRW (RAW) + Fine</b>, <b>NRW (RAW) + Normal</b> or <b>NRW (RAW) + Basic</b></li> </ul>	103 32 48, 49 36 106 68
Cannot set or use Continuous or Auto bracketing.	Another function that is set now is restricting the Continuous setting or Auto bracketing.	108

Problem	Cause/Solution	
Cannot set COOLPIX Picture Control.	Another function that is set now is restricting COOLPIX Picture Control.	108

## Playback

Problem	Cause/Solution	
File cannot be played back.	<ul style="list-style-type: none"> <li>File was overwritten or renamed by computer or another make or model of camera.</li> <li>Interval timer shooting in progress.</li> <li>NRW (RAW) images or movies recorded with cameras other than COOLPIX P7000 cannot be played back.</li> </ul>	– 100 68, 146
Cannot zoom in on picture.	Playback zoom cannot be used with movies, small pictures, or cropped copies of size 320 × 240 pixels and below.	–
Cannot record or play back voice memo.	<ul style="list-style-type: none"> <li>Voice memos cannot be attached to movies.</li> <li>Voice memos cannot be attached to pictures shot by cameras other than the COOLPIX P7000, and voice memos recorded by other cameras cannot be played back.</li> </ul>	151 132
Pictures and movies cannot be edited.	<ul style="list-style-type: none"> <li>Editing other than Black border cannot be performed on pictures shot with <b>Image size</b> of  <b>3648×2432</b>,  <b>3584×2016</b>, and  <b>2736×2736</b>.</li> </ul>	70
	<ul style="list-style-type: none"> <li>No editing other than NRW (RAW) processing can be performed for pictures in the NRW (RAW) format. To edit such pictures, first create JPEG pictures using NRW (RAW) processing, and then edit the JPEG pictures.</li> </ul>	143
	<ul style="list-style-type: none"> <li>Confirm the conditions that are required for editing.</li> <li>Pictures and movies taken with cameras other than COOLPIX P7000 cannot be edited.</li> </ul>	133 –
Pictures not displayed on television.	<ul style="list-style-type: none"> <li><b>Video mode</b> or <b>HDMI</b> is not correctly set in the <b>TV settings</b> setup menu.</li> </ul>	183
	<ul style="list-style-type: none"> <li>Both an HDMI cable and an audio/video cable, or both an HDMI cable and a USB cable are connected.</li> </ul>	154
	<ul style="list-style-type: none"> <li>Memory card contains no pictures. Replace memory card. Remove memory card to play back pictures from internal memory.</li> </ul>	22

## Troubleshooting

Problem	Cause/Solution	
Nikon Transfer 2 does not start when camera is connected to a computer.	<ul style="list-style-type: none"> <li>• Camera is off.</li> <li>• Battery is exhausted.</li> <li>• USB cable is not correctly connected.</li> <li>• Camera is not recognized by the computer.</li> <li>• Confirm that the operating system used is compatible with the camera.</li> <li>• Computer is not set to launch Nikon Transfer 2 automatically. For more information on Nikon Transfer 2, refer to help information contained in ViewNX 2.</li> </ul>	19 24 157 – 156 160
Pictures to be printed are not displayed.	<ul style="list-style-type: none"> <li>• Memory card contains no pictures. Replace memory card.</li> <li>• Remove memory card to print pictures from internal memory.</li> </ul>	22 22
Cannot select paper size with camera.	Paper size cannot be selected from the camera in the following situations, even for PictBridge compatible printers. Use the printer to select page size. <ul style="list-style-type: none"> <li>• The paper size selected using the camera is not compatible with the printer.</li> <li>• A printer that automatically sets the paper size is being used.</li> </ul>	163, 164 –

# Specifications

## Nikon COOLPIX P7000 Digital Camera

Type	Compact digital camera
Effective pixels	10.1 million
Image sensor	1/1.7-in. type CCD; approx. 10.39 million total pixels
Lens	7.1× optical zoom, NIKKOR lens
Focal length	6.0-42.6mm (angle of view equivalent to that of 28-200 mm lens in 35mm [135] format)
f/-number	f/2.8-5.6
Construction	11 elements in 9 groups
Digital zoom	Up to 4× (angle of view equivalent to that of approx. 800 mm lens in 35mm [135] format)
Vibration reduction	Lens shift
Autofocus (AF)	Contrast-detect AF
Focus range (from lens)	<ul style="list-style-type: none"> <li>• Approx. 50 cm (1 ft. 8 in.) to ∞ (wide-angle side), approx. 80 cm (2 ft. 8 in.) to ∞ (telephoto side)</li> <li>• Macro close-up mode: Approx. 2 cm (0.8 in.) to ∞ (wide-angle side of the  icon)</li> </ul>
Focus-area selection	Face priority, auto (9-area automatic selection), center (wide, normal, spot), manual with 99 focus areas, subject tracking
Viewfinder	Real-image optical viewfinder, with diopter adjustment function
Frame coverage	Approx. 80% horizontal and 80% vertical (compared to actual picture)
Monitor	7.5cm (3-in.), approx. 921k-dot, TFT LCD monitor with anti-reflection coating and 5-level brightness adjustment
Frame coverage (shooting mode)	Approx. 97% horizontal and 97% vertical (compared to actual picture)
Frame coverage (playback mode)	Approx. 100% horizontal and 100% vertical (compared to actual picture)
Storage	
Media	Internal memory (approx. 79 MB), SD/SDHC/SDXC memory card
File system	DCF, Exif 2.2, and DPOF compliant
File formats	Still pictures: JPEG, NRW (RAW) <ul style="list-style-type: none"> <li>• RAW and JPEG can be recorded simultaneously</li> </ul> Sound files (Voice Memo): WAV Movies: MOV (Video: MPEG-4 AVC/H.264, Audio: AAC stereo)
Image size (pixels)	<ul style="list-style-type: none"> <li>• 10 M    <b>3648×2736</b>    • 8 M    <b>3264×2448</b></li> <li>• 5 M    <b>2592×1944</b>    • 3 M    <b>2048×1536</b></li> <li>• 2 M    <b>1600×1200</b>    • 1 M    <b>1280×960</b></li> <li>• PC     <b>1024×768</b>     • VGA    <b>640×480</b></li> <li>• 3:2    <b>3648×2432</b>     • 16:9    <b>3584×2016</b></li> <li>• 1:1    <b>2736×2736</b></li> </ul>

## Specifications

ISO sensitivity (Standard output sensitivity)	<ul style="list-style-type: none"> <li>• ISO 100, 200, 400, 800, 1600, 3200, Hi 1 (equivalent to 6400)</li> <li>• Auto (auto gain from ISO 100 to 800)</li> <li>• High ISO Sensitivity auto (ISO 100 to 1600)</li> <li>• Fixed range auto (ISO 100 to 200, 100 to 400)</li> <li>• Low noise night mode (ISO 400 to 12800)</li> </ul>
Exposure	
Metering	256-segment matrix, center-weighted, spot, spot AF area (with support for 99 focus areas)
Exposure control	Programmed auto exposure with flexible program, shutter priority auto, aperture-priority auto, manual, exposure bracketing (Tv), exposure bracketing (Sv), motion detection, exposure compensation (-3.0 to +3.0 EV in steps of 1/3 EV)
Shutter	Mechanical and charge-coupled electronic shutter
Speed	<ul style="list-style-type: none"> <li>• 1/2000 - 8 s (<b>P, S</b> mode)</li> <li>• 1/4000 - 8 s (<b>A</b> mode)</li> <li>• 1/4000 - 60 s (<b>M</b> mode)</li> <li>• 4 s (<b>Fireworks show</b> scene mode)</li> </ul>
Aperture	Electronically-controlled 6-blade iris diaphragm
Range	10 steps of 1/3 EV
Self-timer	Durations of 2 or 10 seconds can be selected
Built-in flash	
Range (approx.) (ISO sensitivity: Auto)	[W]: 0.5 to 6.5 m (1 ft. 8 in. to 21 ft.) [T]: 0.8 to 3 m (2 ft. 8 in. to 9 ft. 10 in.)
Flash control	TTL auto flash with monitor preflashes
Accessory shoe	ISO 518 hot-shoe contact with sync and data contacts and safety lock
Interface	Hi-Speed USB
Data transfer protocol	MTP, PTP
Video output	Can be selected from NTSC and PAL
I/O terminal	Audio/video output; digital I/O (USB); HDMI Mini Connector (HDMI output), External microphone connector (Stereo mini-pin jack (3.5 mm diameter), input impedance 2 k $\Omega$ , sensitivity -42 dB or less, plug-in power type)



Supported languages	Arabic, Chinese (Simplified and Traditional), Czech, Danish, Dutch, English, Finnish, French, German, Greek, Hungarian, Indonesian, Italian, Japanese, Korean, Norwegian, Polish, Portuguese, Russian, Spanish, Swedish, Thai, Turkish
Power sources	<ul style="list-style-type: none"> <li>• One Rechargeable Li-ion Battery EN-EL14 (supplied)</li> <li>• AC Adapter EH-5a (used in combination with the Power Connector EP-5A) (available separately)</li> </ul>
Battery life (EN-EL14)	Still pictures*: Approx. 350 shots Movies: Approx. 2 h 45 min ( <b>HD 720p (1280×720)</b> )
Tripod socket	1/4 (ISO 1222)
Dimensions (W × H × D)	Approx. 114.2 × 77 × 44.8 mm (4.5 × 3.1 × 1.8 in.) (excluding projections)
Weight	Approx. 360 g (12.7 oz) (with battery and SD memory card)
Operating environment	
Temperature	0 to 40 °C (32 to 104 °F)
Humidity	85% and below (no condensation)

- Unless otherwise stated, all figures are for a camera with a fully-charged Rechargeable Li-ion Battery EN-EL14 operated at an ambient temperature of 25 °C (77 °F).

\* Based on Camera and Imaging Products Association (CIPA) standards for measuring the life of camera batteries. Measured at 23 (±2) °C (73 (±4) °F); zoom adjusted with each shot, flash fired with every other shot, Image quality set to **Normal**, Image size set to  **3648×2736**. Battery life may vary depending on shooting interval and length of time menus and images are displayed.

### Rechargeable Li-ion Battery EN-EL14

Type	Rechargeable lithium-ion battery
Rated capacity	DC 7.4 V, 1030 mAh
Operating temperature	0 to 40 °C (32 to 104 °F)
Dimensions (W × H × D)	Approx. 38 × 53 × 14 mm (1.5 × 2.1 × 0.6 in.) (excluding projections)
Weight	Approx. 48 g (1.7 oz) (excluding terminal cover)

### Battery Charger MH-24

Rated input	AC 100 to 240 V, 50/60 Hz, 0.2 A max.
Rated capacity	18 to 24 VA
Rated output	DC 8.4 V, 0.9 A
Supported rechargeable battery	Rechargeable Li-ion Battery EN-EL14
Charging time	Approx. 1 hour and 30 minutes when no charge remains
Operating temperature	0 to 40 °C (32 to 104 °F)
Dimensions (W × H × D)	Approx. 70 × 26 × 97 mm (2.8 × 1.0 × 3.8 in.)
Weight	Approx. 89 g (3.1 oz), excluding plug adapter

### Specifications

- Nikon will not be held liable for any errors this manual may contain.
- The appearance of this product and its specifications are subject to change without notice.

### Supported Standards

- **DCF:** Design Rule for Camera File System is a standard widely used in the digital camera industry to ensure compatibility among different makes of camera.
- **DPOF:** Digital Print Order Format is an industry-wide standard that allows pictures to be printed at a digital photo lab or with a household printer from print orders stored on the memory card.
- **Exif version 2.2:** This camera supports Exif (Exchangeable Image File Format for Digital Still Cameras) version 2.2, a standard that allows information stored with photographs to be used for optimal color reproduction when images are output from Exif-compliant printers.
- **PictBridge:** A standard developed cooperatively by the digital camera and printer industries, allowing photographs to be output directly to a printer without connecting the camera to a computer.

## Approved Memory Cards

The following Secure Digital (SD) memory cards have been tested and approved for use in this camera.

- When recording a movie onto a memory card, a memory card with an SD speed class of Class 6 or higher is recommended. If the transfer speed of the card is slow, the movie recording may end unexpectedly.

	SD memory cards	SDHC memory cards <sup>2</sup>	SDXC memory cards <sup>3</sup>
SanDisk	2 GB <sup>1</sup>	4 GB, 8 GB, 16 GB, 32 GB	64 GB
TOSHIBA	2 GB <sup>1</sup>	4 GB, 8 GB, 16 GB, 32 GB	64 GB
Panasonic	2 GB <sup>1</sup>	4 GB, 8 GB, 12 GB, 16 GB, 24 GB, 32 GB	48 GB, 64 GB
Lexar	2 GB <sup>1</sup>	4 GB, 8 GB, 16 GB, 32 GB	-

- Before using a card reader or similar device, check that the device supports 2 GB cards.
- SDHC-compliant. Before using a card reader or similar device, check that the device supports SDHC.
- SDXC-compliant. Before using a card reader or similar device, check that the device supports SDXC.



- Contact the manufacturer for details on the above cards.

# Index

## Symbols

AE/AF-L 57

AE-L/AF-L button 11, 185

AF area mode 12, 84

**A** Aperture-priority auto mode 60, 64

(apply selection) button 12

**BKT** Auto bracketing 67, 80

Auto mode 24

Av/Tv button 9, 187

Delete button 31, 132, 153

Flash mode 33

Flash pop-up button 33

Focus mode 41

**Fn** FUNC button 11, 107, 186

**QUAL** Image quality/Image size/Movie options 67, 68, 148

**ISO** ISO sensitivity 67, 74

Low noise night mode 58

**M** Manual mode 60, 65

**MENU** Menu button 13

Monitor button 14

Movie mode 146

My menu 67

Playback button 30

Playback mode 30

Playback zoom 118

**P** Programmed auto mode 60, 62

**SCENE** Scene mode 45

Self-timer/Remote control/Smile timer 35, 36, 38

**S** Shutter-priority auto mode 60, 63

**T** Tele 27

Thumbnail display 116

Tone level information 67, 82

**U1/U2/U3** User setting mode 112

**WB** White balance 67, 76

**W** Wide 27

.JPG 203

.MOV 203

.NRW 203

.WAV 203

## A

A/V cable 199

AC adapter 199

Accessory shoe 202

Accessory Shoe Cover 202

Active D-Lighting 106

Adapter Ring 199

AE-L/AF-L button 185

AF area mode 84

AF assist 177

AF lamp 28

Aperture value 61

Aperture-priority auto mode 64

Audio/video cable 154

Audio/video-in jack 154

Auto 32

Auto bracketing 80

Auto mode 24

Auto off 181

Autofocus 41, 102, 150

Autofocus mode 102, 150

AV cable 154

Av/Tv button 187

## B

Backlight 55

Battery 16, 18, 199

Battery charger 16, 199

Battery level indicator 24

Battery-chamber/memory card slot cover 18, 22

Beach 50

Best shot selector 99

Black border 138

Blink warning 189

BSS 99

Built-in flash 32

Built-in ND filter 184

Button sound 179

## C

Calendar display 117

Charger 199

Close-up 52

Color temperature 78

Command dial 9

Computer 156

Continuous 99

Continuous flash 99

Contrast 94  
 Converter lens 199  
 COOLPIX Custom Picture Control 96  
 COOLPIX Picture Control 92  
 Copy  54  
 Crop 145, 152  
 Custom Picture Control 96  
 Customize my menu 187

**D**

Date 20, 170  
 Date imprint 174  
 Daylight saving time 20, 171  
 Delete 31, 127, 132, 153  
 Digital zoom 27, 178  
 Diopter adjustment control 26  
 Distortion control 104  
 D-Lighting 136  
 DPOF printing 166  
 DSCN 203  
 Dusk/dawn  51

**E**

Editing movies 152  
 Exposure compensation 43  
 Exposure compensation dial 43  
 Exposure mode 60  
 Extension 203  
 External flash 111, 199, 202  
 Extracting still pictures 151  
 Eyelet for camera strap 15

**F**

Face priority 84  
 File name 203  
 Fill flash 32  
 Filter effects 94  
 Fireworks show  54  
 Firmware version 194  
 Flash control 105  
 Flash exposure compensation 102  
 Flash lamp 34  
 Flash mode 32  
 Fn button 186  
 Focal length 107, 112, 217  
 Focus 10, 28, 84, 102  
 Focus area 28, 84

Focus lock 29  
 Focus mode 40  
 Folder name 203  
 Food  53  
 Format 23, 182  
 Format the internal memory 182  
 Format the memory card 23, 182  
 FSCN 203  
 Full-frame playback 30, 115  
 Functions that cannot be applied simultaneously 108

**H**

HDMI 154, 183  
 HDMI device control 183  
 HDMI mini connector 154  
 Hide Image 130  
 Histogram 82, 173

**I**







Identifier 203  
 Image copy 131  
 Image quality 68  
 Image sharpening 94  
 Image size 70  
 Infinity 40  
 Initial monitor display 112  
 Internal memory 22  
 Internal memory indicator 25  
 Interval Timer Shooting 99, 100  
 ISO sensitivity 74



**L**

Landscape  48  
 Language 183  
 Lens 197, 217  
 Lens ring 104  
 Lens ring release button 104  
 Li-ion rechargeable battery 16, 199  
 List by date mode 119  
 Lithium-ion type battery 16, 18, 199  
 Long exposure NR 103  
 Low noise night mode 58

**M**

Macro close-up 40  
 Manual 32

- Manual focus 40, 42
- Manual mode 65
- Memory capacity 24
- Memory card 22, 221
- Memory card slot 22
- Metering 98
- Microphone 132, 146
- Miniature effect 142
- Minimum shutter speed 74
- Mode dial 44
- Monitor 6, 8, 197
- Monitor brightness 173
- Monitor brightness boost indicator 15
- Monitor settings 173
- Motion detection 176
- Movie length 149
- Movie menu 149
- Movie mode 146
- Movie options 148
- Movie playback 151
- Movie recording 146
- Multi-shot 16 99
- Museum  54
- My menu 67
- N**
- Night landscape  51
- Night portrait  49
- Nikon Transfer 2 156, 157
- Noise reduction filter 103
- NRW (RAW) Images 69
- NRW (RAW) images 143
- NRW (RAW) processing 143
- Number of exposures remaining 24, 71
- O**
- Off 32
- Optical zoom 27
- Optional accessories 199
- P**
- Panorama assist  55, 56
- Panorama Maker 5 156, 160
- Paper size 163, 164
- Party/indoor  50
- Photo info 173
- PictBridge 161, 220
- Picture Control 92
- Picture editing 133
- Playback 30, 115, 116, 117, 118, 132, 151
- Playback menu 122
- Playback zoom 118
- Portrait  48
- Power 19, 20, 24
- Power connector 199
- Power switch/power-on lamp 19
- Preset manual 79
- Press halfway 10
- Print 161, 163, 164
- Print set 123
- Print Set Date Option 124
- Printer 161
- Programmed auto mode 62
- Protect 129
- Q**
- Quick adjust 94
- Quick menu 67
- Quick menu button 67
- Quick menu dial 67
- Quick retouch 135
- R**
- Rear-curtain sync 32
- Rechargeable battery 199
- Record orientation 180
- Red-eye reduction 32, 177
- Remote control 38
- Reset all 191
- Reset file numbering 188
- Resetting Saved Settings 114
- Rotary multi selector 12
- Rotate image 130
- RSCN 203
- S**
- Saturation 94
- Save to user setting 113
- Scene auto selector  46
- Scene mode 45
- Selecting pictures 128
- Self-timer 35
- Self-timer lamp 35
- Setup menu 167

Shooting 24, 44  
Shooting date information 14, 82  
Shooting menu 90  
Shooting with Face Priority 86  
Shutter sound 179  
Shutter speed 61  
Shutter-priority auto mode 63  
Shutter-release button 28  
Single 99  
Skin softening 36, 37, 139  
Slide show 126  
Slow sync 32  
Small picture 137  
Smile timer 36  
Snow  50  
Sound settings 179  
Speedlight 111, 199, 202  
Sports  49  
SSCN 203  
Straighten 141  
Subject tracking 85, 88  
Sunset  51  
Switching between tabs 14

## **I**

Tele 27  
Television 154  
Thumbnail display 116  
Time difference 172  
Time zone 172  
Toggle Av/Tv selection 66, 187  
Tone level information 82  
Toning 95  
TV settings 183

## **U**

USB cable 157, 162, 199  
USB/Audio video connector 162  
USB/audio/video output connector 154, 157  
User setting mode 112

## **V**

Vibration reduction 175  
Video output 183  
View grid 93  
View/hide framing grid 173

Viewfinder 26, 197  
ViewNX 2 156, 160  
Virtual horizon 173  
Voice memo 132  
Volume 151

## **W**

Welcome screen 169  
White balance 76  
Wide 27  
Wide-angle converter 104, 199  
Wind noise reduction 150

## **Z**

Zoom 27  
Zoom control 27  
Zoom memory 107  
Zoom speed 179

# **Nikon**

No reproduction in any form of this manual, in whole or in part (except for brief quotation in critical articles or reviews), may be made without written authorization from NIKON CORPORATION.



**NIKON CORPORATION**

Printed in Japan

© 2010 Nikon Corporation

FX0102(11)  
6MM83111-02